

Compact Inverter
FRENIC-Mini

User's Manual

Copyright © 2002-2007 Fuji Electric FA Components & Systems Co., Ltd.

All rights reserved.

No part of this publication may be reproduced or copied without prior written permission from Fuji Electric FA Components & Systems Co., Ltd.

All products and company names mentioned in this manual are trademarks or registered trademarks of their respective holders.

The information contained herein is subject to change without prior notice for improvement.

Preface

This manual provides all the information on the FRENIC-Mini series of inverters including its operating procedure, operation modes, and selection of peripheral equipment. Carefully read this manual for proper use. Incorrect handling of the inverter may prevent the inverter and/or related equipment from operating correctly, shorten their lives, or cause problems.

Listed below are the other materials related to the use of the FRENIC-Mini. Read them in conjunction with this manual as necessary.

- FRENIC-Mini Instruction Manual
- RS-485 Communication User's Manual
- Catalog
- Application Guide
- RS-485 Communications Card Installation Manual
- Rail Mounting Base Installation Manual
- Mounting Adapter Installation Manual
- FRENIC Loader Instruction Manual
- Remote Keypad Instruction Manual
- Built-in Braking Resistor Installation Manual

The materials are subject to change without notice. Be sure to obtain the latest editions for use.

Documents related to Fuji inverters

Catalogs

FRENIC5000G11S/P11S
FRENIC-Eco
FRENIC5000VG7S



User's Manuals and Technical Information

FRENIC5000G11S/P11S Technical Information
FRENIC-Eco User's Manual
FRENIC5000VG7S Series User's Manual

Safety precautions

Read this manual thoroughly before proceeding with installation, connections (wiring), operation, or maintenance and inspection. Ensure you have sound knowledge of the device and familiarize yourself with all safety information and precautions before proceeding to operate the inverter.

Safety precautions are classified into the following two categories in this manual.

 WARNING	Failure to heed the information indicated by this symbol may lead to dangerous conditions, possibly resulting in death or serious bodily injuries.
 CAUTION	Failure to heed the information indicated by this symbol may lead to dangerous conditions, possibly resulting in minor or light bodily injuries and/or substantial property damage.

Failure to heed the information contained under the CAUTION title can also result in serious consequences. These safety precautions are of utmost importance and must be observed at all times.

 CAUTION
This product is not designed for use in appliances and machinery on which lives depend. Consult your Fuji Electric representative before considering the FRENIC-Mini series of inverters for equipment and machinery related to nuclear power control, aerospace uses, medical uses or transportation. When the product is to be used with any machinery or equipment on which lives depend or with machinery or equipment which could cause serious loss or damage should this product malfunction or fail, ensure that appropriate safety devices and/or equipment are installed.

■ Precautions for Use

In running general-purpose motors	Driving a 460V general-purpose motor	When driving a 460V general-purpose motor with an inverter using extremely long wires, damage to the insulation of the motor may occur. Use an output circuit filter (OFL) if necessary after checking with the motor manufacturer. Fuji motors do not require the use of output circuit filters because of their good insulation.
	Torque characteristics and temperature rise	When the inverter is used to run a general-purpose motor, the temperature of the motor becomes higher than when it is operated using a commercial power supply. In the low-speed range, the cooling effect will be weakened, so decrease the output torque of the motor. If constant torque is required in the low-speed range, use a Fuji inverter motor or a motor equipped with an externally powered ventilating fan.
	Vibration	When an inverter-driven motor is mounted to a machine, resonance may be caused by the natural frequencies of the machine system. Note that operation of a 2-pole motor at 60 Hz or higher may cause abnormal vibration. * The use of a rubber coupling or vibration dampening rubber is recommended. * Use the inverter's jump frequency control feature to skip the resonance frequency zone(s).
	Noise	When an inverter is used with a general-purpose motor, the motor noise level is higher than that with a commercial power supply. To reduce noise, raise carrier frequency of the inverter. Operation at 60 Hz or higher can also result in higher noise level.
In running special motors	High-speed motors	If the set frequency is set to 120 Hz or more to drive a high-speed motor, test-run the combination of the inverter and motor beforehand to check for safe operation.
	Explosion-proof motors	When driving an explosion-proof motor with an inverter, use a combination of a motor and an inverter that has been approved in advance.
	Submersible motors and pumps	These motors have a larger rated current than general-purpose motors. Select an inverter whose rated output current is greater than that of the motor. These motors differ from general-purpose motors in thermal characteristics. Set a low value in the thermal time constant of the motor when setting the electronic thermal overload protection.
	Brake motors	For motors equipped with parallel-connected brakes, their braking power must be supplied from the primary circuit. If the brake power is connected to the inverter's power output circuit by mistake, the brake will not work. Do not use inverters for driving motors equipped with series-connected brakes.

In running special motors	Geared motors	If the power transmission mechanism uses an oil-lubricated gearbox or speed changer/reducer, then continuous motor operation at low speed may cause poor lubrication. Avoid such operation.
	Synchronous motors	It is necessary to take special measures suitable for this motor type. Contact your Fuji Electric representative for details.
	Single-phase motors	Single-phase motors are not suitable for inverter-driven variable speed operation. Use three-phase motors. * Even a single-phase inverter provides three-phase output, so use a three-phase motor.
Environmental conditions	Installation location	Use the inverter within the ambient temperature range from -10 to +50°C (+14 to 122°F). The heat sink and braking resistor of the inverter may become hot under certain operating conditions, so install the inverter on nonflammable material such as metal. Ensure that the installation location meets the environmental conditions specified in Chapter 8, Section 8.5 "Operating Environment and Storage Environment."
Combination with peripheral devices	Installing an MCCB or RCD/GFCI	Install a recommended molded case circuit breaker (MCCB) or residual-current-operated protective device (RCD)/ground-fault circuit interrupter (GFCI) (with overcurrent protection) in the primary circuit of the inverter to protect the wiring. Ensure that the circuit breaker capacity is equivalent to or lower than the recommended capacity.
	Installing an MC in the secondary circuit	If a magnetic contactor (MC) is mounted in the inverter's secondary circuit for switching the motor to commercial power or for any other purpose, ensure that both the inverter and the motor are completely stopped before you turn the MC on or off. Do not connect a magnet contactor united with a surge killer to the inverter's secondary circuit.
	Installing an MC in the primary circuit	Do not turn the magnetic contactor (MC) in the primary circuit on or off more than once an hour as an inverter failure may result. If frequent starts or stops are required during motor operation, use FWD/REV signals or the RUN/STOP key.
	Protecting the motor	The electronic thermal overload protection function of the inverter can protect the motor. The operation level and the motor type (general-purpose motor, inverter motor) should be set. For high-speed motors or water-cooled motors, set a small value for the thermal time constant and protect the motor. If you connect the motor thermal relay to the motor with a long wire, a high-frequency current may flow into the wiring stray capacitance. This may cause the relay to trip at a current lower than the set value for the thermal relay. If this happens, lower the carrier frequency or use the output circuit filter (OFL).

Combination with peripheral devices	Discontinuance of power-factor correcting capacitor	Do not mount power-factor correcting capacitors in the inverter's primary circuit. (Use the DC reactor to improve the inverter power factor.) Do not use power-factor correcting capacitors in the inverter output circuit. An overcurrent trip will occur, disabling motor operation.
	Discontinuance of surge killer	Do not connect a surge killer to the inverter's secondary circuit.
	Reducing noise	Use of a filter and shielded wires is typically recommended to satisfy EMC directives.
	Measures against surge currents	If an overvoltage trip occurs while the inverter is stopped or operated under a light load, it is assumed that the surge current is generated by open/close of the phase-advancing capacitor in the power system. * Connect a DC reactor to the inverter.
	Megger test	When checking the insulation resistance of the inverter, use a 500 V megger and follow the instructions contained in the FRENIC-Mini Instruction Manual, Chapter 7, Section 7.4 "Insulation Test."
Wiring	Control circuit wiring length	When using remote control, limit the wiring length between the inverter and operator box to 65.6 ft (20 m) or less and use twisted pair or shielded cable.
	Wiring length between inverter and motor	If long wiring is used between the inverter and the motor, the inverter will overheat or trip as a result of overcurrent (high-frequency current flowing into the stray capacitance) in the wires connected to the phases. Ensure that the wiring is shorter than 164 ft (50 m). If this length must be exceeded, lower the carrier frequency or mount an output circuit filter (OFL).
	Wiring size	Select wires with a sufficient capacity by referring to the current value or recommended wire size.
	Wiring type	Do not use one multicore cable in order to connect several inverters with motors.
	Grounding	Securely ground the inverter using the grounding terminal.
Selecting inverter capacity	Driving general-purpose motor	Select an inverter according to the applicable motor ratings listed in the standard specifications table for the inverter. When high starting torque is required or quick acceleration or deceleration is required, select an inverter with a capacity one size greater than the standard.
	Driving special motors	Select an inverter that meets the following condition: Inverter rated current > Motor rated current
Transportation and storage	When transporting or storing inverters, follow the procedures and select locations that meet the environmental conditions listed in Chapter 1, Section 1.3 "Transportation" and Section 1.4 "Storage Environment."	

How this manual is organized

This manual contains chapters 1 through 9, appendices and glossary.

Part 1 General Information

Chapter 1 INTRODUCTION TO FRENIC-Mini

This chapter describes the features and control system of the FRENIC-Mini series, and the recommended configuration for the inverter and peripheral equipment.

Chapter 2 PARTS NAMES AND FUNCTIONS

This chapter contains external views of the FRENIC-Mini series and an overview of terminal blocks, including a description of the LED display and keys on the keypad.

Chapter 3 OPERATION USING THE KEYPAD

This chapter describes inverter operation using the keypad. The inverter features three operation modes (Running, Programming and Alarm modes) which enable you to run and stop the motor, monitor running status, set function code data, display running information required for maintenance, and display alarm data.

Part 2 Driving the Motor

Chapter 4 BLOCK DIAGRAMS FOR CONTROL LOGIC

This chapter describes the main block diagrams for the control logic of the FRENIC-Mini series of inverters.

Chapter 5 RUNNING THROUGH RS-485 COMMUNICATION (OPTION)

This chapter describes an overview of inverter operation through the RS-485 communications facility. Refer to the RS-485 Communication User's Manual for details.

Part 3 Peripheral Equipment and Options

Chapter 6 SELECTING PERIPHERAL EQUIPMENT

This chapter describes how to use a range of peripheral equipment and options, FRENIC-Mini's configuration with them, and requirements and precautions for selecting wires and crimp terminals.

Part 4 Selecting Optimal Inverter Model

Chapter 7 SELECTING OPTIMAL MOTOR AND INVERTER CAPACITIES

This chapter provides you with information about the inverter output torque characteristics, selection procedure, and equations for calculating capacities to help you select optimal motor and inverter models. It also helps you select braking resistors.

Chapter 8 SPECIFICATIONS

This chapter describes specifications of the output ratings, control system, and terminal functions for the FRENIC-Mini series of inverters. It also provides descriptions of the operating and storage environment, external dimensions, examples of basic connection diagrams, and details of the protective functions.

Chapter 9 FUNCTION CODES

This chapter contains overview lists of seven groups of function codes available for the FRENIC-Mini series of inverters and details of each function code.

Appendices

- App.A Advantageous Use of Inverters (Notes on electrical noise)
- App.B Japanese Guideline for Suppressing Harmonics by Customers Receiving High Voltage or Special High Voltage
- App.C Effect on Insulation of General-purpose Motors Driven with 460 V Class Inverters
- App.D Inverter Generating Loss
- App.E Conversion from SI Units
- App.F Allowable Current of Insulated Wires
- App.G Replacement Information

Glossary

Icons

The following icons are used throughout this manual.



This icon indicates information which, if not heeded, can result in the inverter not operating to full efficiency, as well as information concerning incorrect operations and settings which can result in accidents.



This icon indicates information that can prove handy when performing certain settings or operations.



This icon indicates a reference to more detailed information.

CONTENTS

Part 1 General Information

Chapter 1 INTRODUCTION TO FRENIC-Mini

1.1	Features.....	1-1
1.2	Control System	1-8
1.3	Recommended Configuration	1-9

Chapter 2 PARTS NAMES AND FUNCTIONS

2.1	External View and Allocation of Terminal Blocks.....	2-1
2.2	LED Monitor, Potentiometer and Keys on the Keypad	2-2

Chapter 3 OPERATION USING THE KEYPAD

3.1	Overview of Operation Modes	3-1
3.2	Running Mode	3-3
3.2.1	Run/stop the motor	3-3
3.2.2	Set up the set frequency and others	3-3
3.2.3	Monitor the running status	3-5
3.2.4	Jog (inch) the motor	3-7
3.3	Programming Mode	3-8
3.3.1	Setting the function codes--"Data Setting"	3-9
3.3.2	Checking changed function codes--"Data Checking"	3-13
3.3.3	Monitoring the running status--"Drive Monitoring"	3-14
3.3.4	Checking I/O signal status--"I/O Checking"	3-17
3.3.5	Reading maintenance information--"Maintenance Information"	3-21
3.3.6	Reading alarm information--"Alarm Information"	3-22
3.4	Alarm Mode.....	3-26
3.4.1	Releasing the alarm and transferring the inverter to Running mode	3-26
3.4.2	Displaying the alarm history	3-26
3.4.3	Displaying the running information when an alarm occurs	3-27
3.4.4	Transferring to Programming mode	3-27

Part 2 Driving the Motor

Chapter 4 BLOCK DIAGRAMS FOR CONTROL LOGIC

4.1	Symbols Used in the Block Diagrams and their Meanings.....	4-1
4.2	Drive Frequency Command Generator	4-2
4.3	Drive Command Generator.....	4-4
4.4	Terminal Command Decoders	4-6
4.5	Digital Output Selector	4-10
4.6	Analog Output (FMA) Selector	4-12
4.7	Drive Command Controller	4-14
4.8	PID Frequency Command Generator.....	4-16

Chapter 5 RUNNING THROUGH RS-485 COMMUNICATION (OPTION)

5.1	Overview on RS-485 Communication.....	5-1
5.1.1	Common specifications.....	5-2
5.1.2	Connector specifications.....	5-3
5.1.3	Connection.....	5-3

Part 3 Peripheral Equipment and Options

Chapter 6 SELECTING PERIPHERAL EQUIPMENT

6.1	Configuring the FRENIC-Mini.....	6-1
6.2	Selecting Wires and Crimp Terminals.....	6-2
6.2.1	Recommended wires.....	6-4
6.2.2	Crimp terminals.....	6-6
6.3	Peripheral Equipment.....	6-7
6.4	Selecting Options.....	6-13
6.4.1	Peripheral equipment options.....	6-13
6.4.2	Options for operation and communications.....	6-21
6.4.3	Extended installation kit options.....	6-24
6.4.4	Meter options.....	6-27

Part 4 Selecting Optimal Inverter Model

Chapter 7 SELECTING OPTIMAL MOTOR AND INVERTER CAPACITIES

7.1	Selecting Motors and Inverters.....	7-1
7.1.1	Motor output torque characteristics.....	7-1
7.1.2	Selection procedure.....	7-4
7.1.3	Equations for selections.....	7-7
7.1.3.1	Load torque during constant speed running.....	7-7
7.1.3.2	Acceleration and deceleration time calculation.....	7-8
7.1.3.3	Heat energy calculation of braking resistor.....	7-11
7.1.3.4	Calculating the RMS rating of the motor.....	7-12
7.2	Selecting a Braking Resistor.....	7-13
7.2.1	Selection procedure.....	7-13
7.2.2	Notes on selection.....	7-13

Chapter 8 SPECIFICATIONS

8.1	Standard Models	8-1
8.1.1	Three-phase 230 V	8-1
8.1.2	Three-phase 460 V	8-2
8.1.3	Single-phase 230 V	8-3
8.2	Models Available on Order	8-4
8.2.1	EMC filter built-in type.....	8-4
8.2.1.1	Three-phase 230 V	8-4
8.2.1.2	Three-phase 460 V	8-5
8.2.1.3	Single-phase 230 V	8-6
8.2.2	Braking resistor built-in type.....	8-7
8.2.2.1	Three-phase 230 V	8-7
8.2.2.2	Three-phase 460 V	8-8
8.3	Common Specifications.....	8-9
8.4	Terminal Specifications	8-11
8.4.1	Terminal functions	8-11
8.4.2	Terminal block arrangement.....	8-23
8.4.3	Terminal arrangement diagram and screw specifications.....	8-24
8.4.3.1	Main circuit terminals	8-24
8.4.3.2	Control circuit terminal	8-25
8.5	Operating Environment and Storage Environment	8-26
8.5.1	Operating environment.....	8-26
8.5.2	Storage environment	8-27
8.5.2.1	Temporary storage.....	8-27
8.5.2.2	Long-term storage	8-27
8.6	External Dimensions.....	8-28
8.6.1	Standard models and models available on order (braking resistor built-in type)	8-28
8.6.2	Models available on order (EMC filter built-in type).....	8-30
8.7	Connection Diagrams	8-32
8.7.1	Keypad operation	8-32
8.7.2	Operation by external signal inputs.....	8-33
8.8	Details of Protective Functions.....	8-34

Chapter 9 FUNCTION CODES

9.1	Function Code Tables	9-1
9.2	Details of Function Codes.....	9-12
9.2.1	F codes (Fundamental functions)	9-12
9.2.2	E codes (Extension terminal functions).....	9-33
9.2.3	C codes (Control functions of frequency)	9-46
9.2.4	P codes (Motor parameters)	9-49
9.2.5	H codes (High performance functions)	9-51
9.2.6	J codes (Application functions).....	9-64
9.2.7	y codes (Link functions).....	9-70

Appendices

App.A	Advantageous Use of Inverters (Notes on electrical noise).....	A-1
A.1	Effect of inverters on other devices.....	A-1
A.2	Noise	A-2
A.3	Noise prevention	A-4
App.B	Japanese Guideline for Suppressing Harmonics by Customers Receiving High Voltage or Special High Voltage	A-12
B.1	Application to general-purpose inverters	A-12
B.2	Compliance to the harmonic suppression for customers receiving high voltage or special high voltage.....	A-13
App.C	Effect on Insulation of General-purpose Motors Driven with 460 V Class Inverters.....	A-17
C.1	Generating mechanism of surge voltages.....	A-17
C.2	Effect of surge voltages.....	A-18
C.3	Countermeasures against surge voltages.....	A-18
C.4	Regarding existing equipment.....	A-19
App.D	Inverter Generating Loss	A-20
App.E	Conversion from SI Units.....	A-21
App.F	Allowable Current of Insulated Wires	A-23
App.G	Replacement Information	A-25
G.1	External dimensions comparison tables	A-25
G.2	Terminal arrangements and symbols	A-29
G.3	Function codes	A-31

Glossary

Part 1 General Information



Chapter 1 INTRODUCTION TO FRENIC-Mini

Chapter 2 PARTS NAMES AND FUNCTIONS

Chapter 3 OPERATION USING THE KEYPAD

Chapter 1

INTRODUCTION TO FRENIC-Mini

This chapter describes the features and control system of the FRENIC-Mini series, and the recommended configuration for the inverter and peripheral equipment.

Contents

1.1	Features	1-1
1.2	Control System.....	1-8
1.3	Recommended Configuration	1-9

1.1 Features

Optimum performance for traversing conveyors

- High starting torque, at 150% or more

Equipped with Fuji's original simplified torque-vector control system and the automatic torque boost function, these inverters ensure consistent and powerful operation (when automatic torque boost and slip compensation control are ON and start frequency is set at 5 Hz or more).

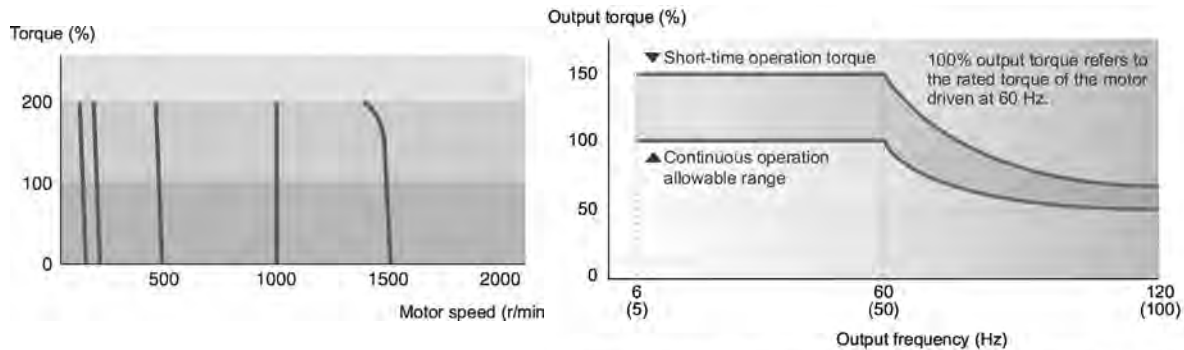

Figure 1.1 Torque Characteristics Data
(Automatic torque boost: ON)

* The above graph shows an example of torque characteristics obtained when FRENIC-Mini is combined one-to-one with Fuji standard three-phase motor (8-type series: 4 poles).

Figure 1.2 Example of Output Torque Characteristics

- Braking resistor connectable to the inverter

FRENIC-Mini series of inverters features a built-in braking transistor (for inverters of 1/2 HP or larger), which makes it possible for an optional braking resistor to be connected to increase the regenerative braking ability for conveyance and transportation machinery that requires strong braking power. For inverters of 2 HP or larger, it is also possible to select a model that incorporates a built-in braking resistor.

 Refer to Chapter 8, Section 8.2.2 "Braking resistor built-in type" for details.

- Trip-free operation

The remarkably improved current limiting function (stall prevention) ensures trip-free operation even for impact loads.

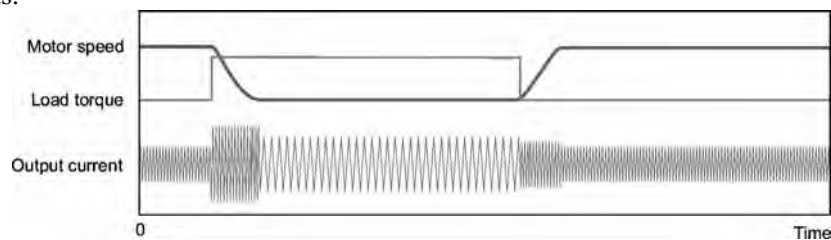

Figure 1.3 Example of Response for Impact Load Torque

- Stable operation even for a step load

The slip compensation function ensures stable operation even when the motor load fluctuates (step load).

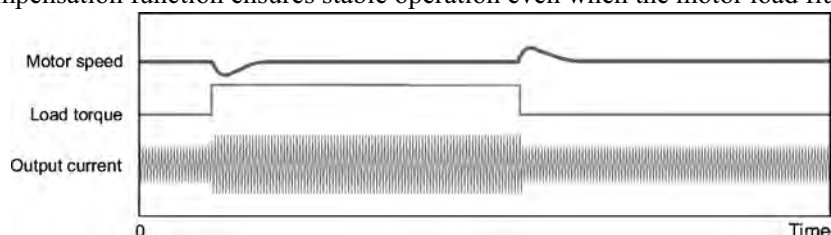

Figure 1.4 Example of Response for Step Load Torque (Refer to the note in Figure 1.2 for the test configuration.)

- Reduced motor instability at low speed

Fuji's unique control method improves voltage control performance and reduces motor instability at low speed to about a half or under (at 1 Hz) compared with that of conventional inverters.

Refer to Chapter 4, Section 4.7 "Drive Command Controller" for details.

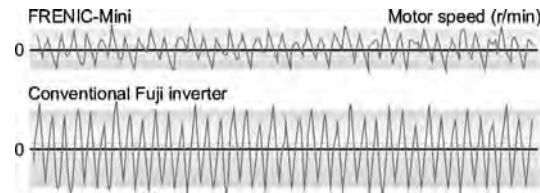

Figure 1.5 Example of Instability Characteristics

Default functions for fans and pumps

- Automatic energy-saving function provided as standard

To minimize the total loss (motor loss plus inverter loss), rather than just the motor loss as in the predecessor models, FRENIC-Mini saves even more power when used with fans or pumps.

Refer to Chapter 4, Section 4.7 "Drive Command Controller" for details.

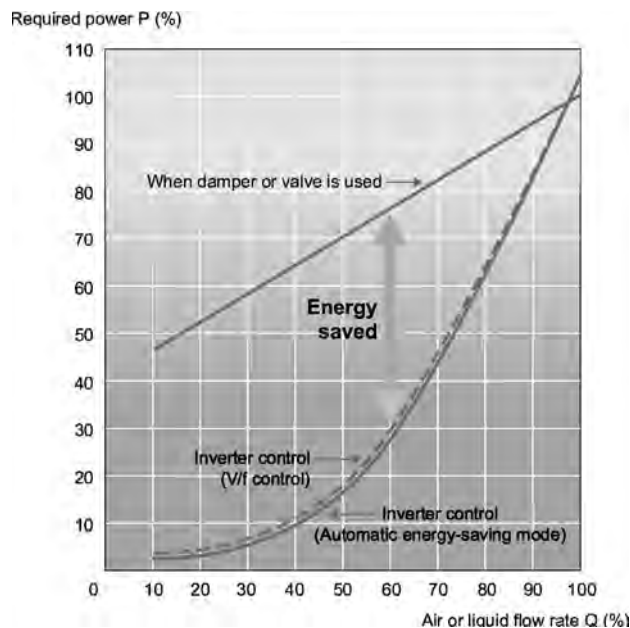

* Energy savings vary depending on the motor characteristics.

Figure 1.6 Example of Energy Savings

- PID control function

Permits motor operation while controlling temperature, pressure, or flow rate without using an external device such as a temperature regulator.

Refer to Chapter 4, Section 4.8 "PID Frequency Command Generator" for details.

- Cooling fan ON/OFF control function

The inverter's cooling fan can be turned off while the fan or pump is stopped for noise reduction and energy savings.

The ideal functions to serve a multiplicity of needs for small-capacity inverters

- Compatible with a wide range of frequency settings

You can select the optimum frequency setting method that matches your machine or equipment via the keypad (▲/▼ keys or potentiometer), analog input (4 to 20 mA, 0 to 10 V, 0 to 5 V, 1 to 5 V), multistep speed settings (0 to 7 steps) or via RS-485 communications. (Refer to Chapter 4, Section 4.2 "Drive Frequency Command Generator" and Chapter 9, Section 9.2.1 "F codes" for details.)

- A transistor output is provided

This enables an overload early warning, lifetime forecast or other information signals to be output during operation.

 Refer to function code E20 in Chapter 9, Section 9.2.2 "E codes (Extension terminal functions)."

- High output frequency - up to 400 Hz

The inverter can be used with equipment such as centrifugal separators that require a high motor speed. In this case, you need to check whether the machine operation in combination with the motor is compatible or not.

- Two points can be set for a non-linear V/f pattern.

The addition of an extra point (total: 2 points) for the non-linear V/f pattern, which can be set as desired, improves the FRENIC-Mini's drive capability, because the V/f pattern can be adjusted to match a wider application area.

 Refer to Chapter 4, Section 4.7 "Drive Command Controller" for details.

Compact size

- Side-by-side mounting

More than one FRENIC-Mini inverter can be mounted side-by-side without any gap inside your system control panel, thereby reducing the amount of space required for installation. (Ambient temperature: 40°C (104°F) or lower)

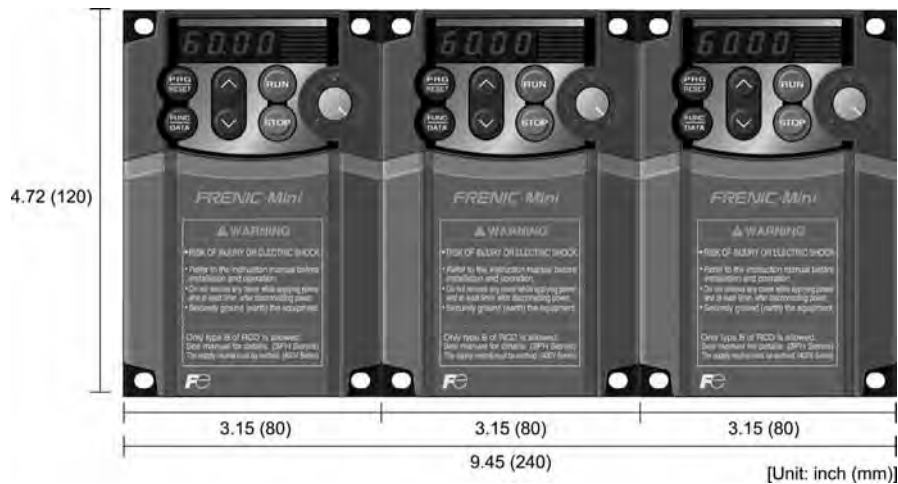

(Example: Inverters of 3-phase 230 V, 1 HP or less)

- External dimensions compatible with Fuji FVR-C11S series

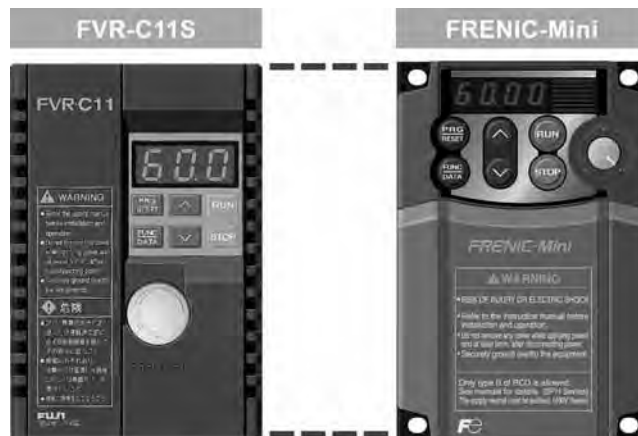

- RS-485 communications card (option) can be installed internally

This card can be installed inside the inverter's body without changing the dimensions. RS-485 communication is available as option.

 Refer to Chapter 5, "RUNNING THROUGH RS-485 COMMUNICATION (OPTION)."



RS-485 communications card (option)

(Example: Inverters of 3-phase 230 V, 1 HP or less)

- Models with built-in braking resistor are available on order

Inverters of 2 HP or over are available in a braking resistor built-in type. Requiring no installation or wiring of an external braking resistor reduces the total mounting space.

 Refer to Chapter 8, Section 8.2.2 "Braking resistor built-in type."

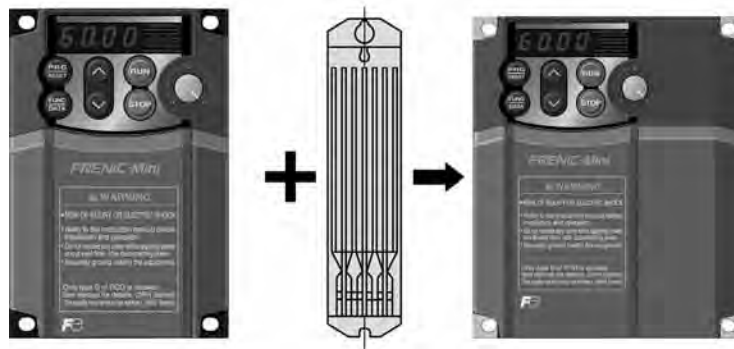

(Example: Inverters of 3-phase 230V, 2 HP)

Simplified operation and wiring

- Frequency setting potentiometer is standard equipment

The frequency can be adjusted easily by hand.

- Easy-to-remove/replace terminal block covers (for control circuit and main circuit)

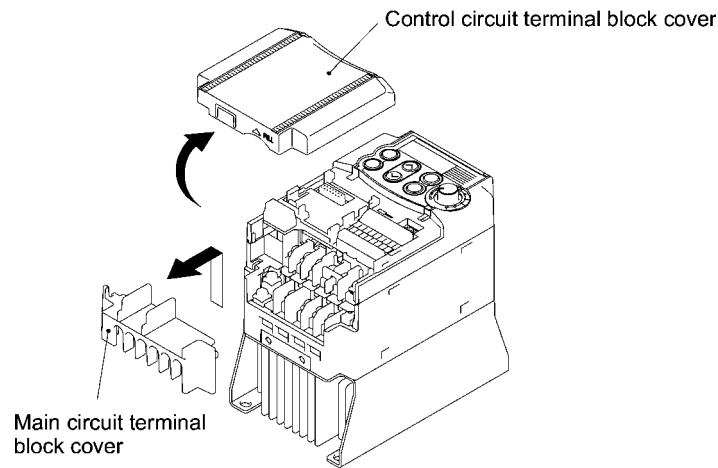

- LED monitor on the keypad displaying all types of data

You can access and monitor all types of inverter's data and information including output frequency, set frequency, load shaft speed, output current, output voltage, alarm history, input power etc. using built-in keypad with LED.

 Refer to Chapter 3, "OPERATION USING THE KEYPAD."



- Menu mode accessible from the keypad

You can easily access the menu mode including "Data setting," "Data checking," "Drive monitoring," "I/O checking," "Maintenance information," and "Alarm information."

 Refer to Chapter 3, "OPERATION USING THE KEYPAD."

Maintenance

FRENIC-Mini series features the following facilities useful for maintenance.



Refer to Chapter 3, Section 3.3.5 "Reading Maintenance Information" and the FRENIC-Mini Instruction Manual, Chapter 7 "MAINTENANCE AND INSPECTION" for details.

- The lifetime of the DC link bus capacitor (reservoir capacitor) can be estimated

The capacitor's condition compared with its initial state can be confirmed.

- Long-life cooling fan

Use of a long-life cooling fan (estimated service life: 7 years for operation at an ambient temperature of 40°C (104°F)) reduces maintenance cost.

- Recording and display of cumulative running time of the inverter

The inverter records and displays the accumulated running time of the inverter itself, the printed circuit board and cooling fan.

- Alarm history for up to 4 latest alarms

The inverter records detailed information for up to 4 alarms that occurred most recently, which can also be displayed on the LED.



Refer to Chapter 3, Section 3.3.6 "Reading alarm information."

- Lifetime forecast signal via transistor output

This signal is output when the reservoir capacitor in the DC link bus, the electrolytic capacitors on the printed circuit board, or the cooling fans have been nearing the end of their service life.



Refer to function code E20 in Chapter 9, Section 9.2.2 "E codes (Extension terminal functions)" for details.

Interface for peripheral devices and comprehensive protective functions

- All models are equipped with an inrush current suppression circuit.

FRENIC-Mini series features an inrush current suppression circuit as standard in all models to reduce the cost of peripheral devices such as input magnetic contactor.

- Terminals for a DC reactor (DCR) provided as standard

Terminals for connection of a DCR, which are necessary for suppressing harmonics, are provided as standard in all models.

- Input/output phase loss protective function

FRENIC-Mini series can detect output phase loss at all times during starting and running. This feature assists you for keeping operation of your system stable.

- Switchable sink/source

The input/output mode (sink/source) of the digital input terminals can be switched by means of an internal jumper switch. No engineering change is required in other control devices including PLC.

- Motor can be protected by a PTC thermistor

The motor is protected by PTC (Positive Temperature Coefficient) thermistor which detects the motor's temperature and stops the inverter before the motor is overheated.

Flexible through optionals

- Function code copy function

The optional remote keypad includes a built-in copy facility, so you can copy function code data set in a source inverter and duplicate it into a destination inverter.

- Inverter support loader software available

The inverter support loader program (Windows-based), which simplifies the setting of function codes, is provided as an option.

 Refer to Chapter 5, "RUNNING THROUGH RS-485 COMMUNICATION (OPTION)" for details.

- Mounting on DIN rail

Using the rail-mounting base (option), the inverter can easily be mounted on a DIN rail [1.38 inch (35 mm) wide].

 Refer to Chapter 6, "SELECTING PERIPHERAL EQUIPMENT" for details.

- Easy replacement of older models with new ones

Using the mounting adapter (option) makes it possible to mount the latest models without drilling any additional holes.

 Refer to Chapter 6, "SELECTING PERIPHERAL EQUIPMENT" for details.

- Remote operation

Using the optional RS-485 communications card and remote keypad together with remote operation extension cable enables you to easily operate the inverter from a remote location, such as outside the control panel where the inverter is installed.

 Refer to Chapter 5, "RUNNING THROUGH RS-485 COMMUNICATION (OPTION)" and Chapter 6, "SELECTING PERIPHERAL EQUIPMENT" for details.

Wide variations

The wide range of models available in the FRENIC-Mini series of inverters is certain to flexibly meet your various system needs.

- The 460 V series is available in addition to the 230 V series (3-phase, single-phase).
- Models with built-in EMC filter and built-in braking resistors are also available.
- An optional RS-485 communications card enables your system to feature network driven management.

 Refer to Chapter 8, "SPECIFICATIONS" for details.

Global products

FRENIC-Mini series of inverters are designed for use in global market in conformity with the global standards listed below.

- All standard models conform to the EC Directive (CE Marking), UL standards (UL-Listed) and Canadian standards (cUL-Listed).

All standard FRENIC-Mini inverters conform to European and North American/Canadian standards, enabling standardization of the specifications for machines and equipment used at home and abroad.

- If a model with a built-in EMC filter is used, the model conforms to the European EMC Directive.



1.2 Control System

This section gives you a general overview of inverter control systems and features specific to the FRENIC-Mini series of inverters.

As shown in Figure 1.8, single- or three-phase commercial power is converted to DC power in the converter section, which is then used to charge the capacitor on the DC link bus. According to control commands or signals generated in the control logic, the inverter modulates the electricity charged in the capacitor to PWM (Pulse Width Modulation) format and feeds the output to the motor. The modulation frequency is called "carrier frequency." As shown in Figure 1.7, the voltage waveform of the modulated power source produces pulse train with positive and negative polarity synchronized with the inverter's output command frequency. The inverter feeds the produced output as drive power with sinusoidal current waveform like that of ordinary commercial power lines.

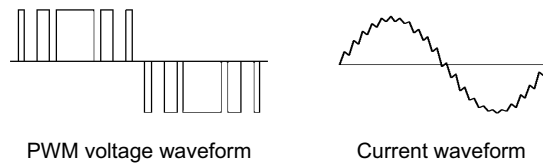



Figure 1.7 Output Voltage and Current Waveform of the Inverter

For the set frequency given in the control logic, the accelerator/decelerator processor calculates the acceleration/deceleration rate required by run/stop control of the motor and transfers the calculated results to the 3-phase voltage command processor directly or via the V/f pattern generator.

 Refer to Chapter 4, Section 4.7 "Drive Command Controller" for details.

The FRENIC-Mini series features a simplified magnetic flux estimator which is added in the V/f pattern processing section. This feature automatically controls the voltage level applied to the motor according to the motor load so as to make the motor generate more stable and higher torque even during low speed operation. This "Simplified Torque-Vector Control" is unique to Fuji inverters.

The control logic section, which is the very brain of the inverter, allows you to customize the inverter's driving patterns using the function code settings.

 Refer to Chapter 4 "BLOCK DIAGRAMS FOR CONTROL LOGIC" for details.

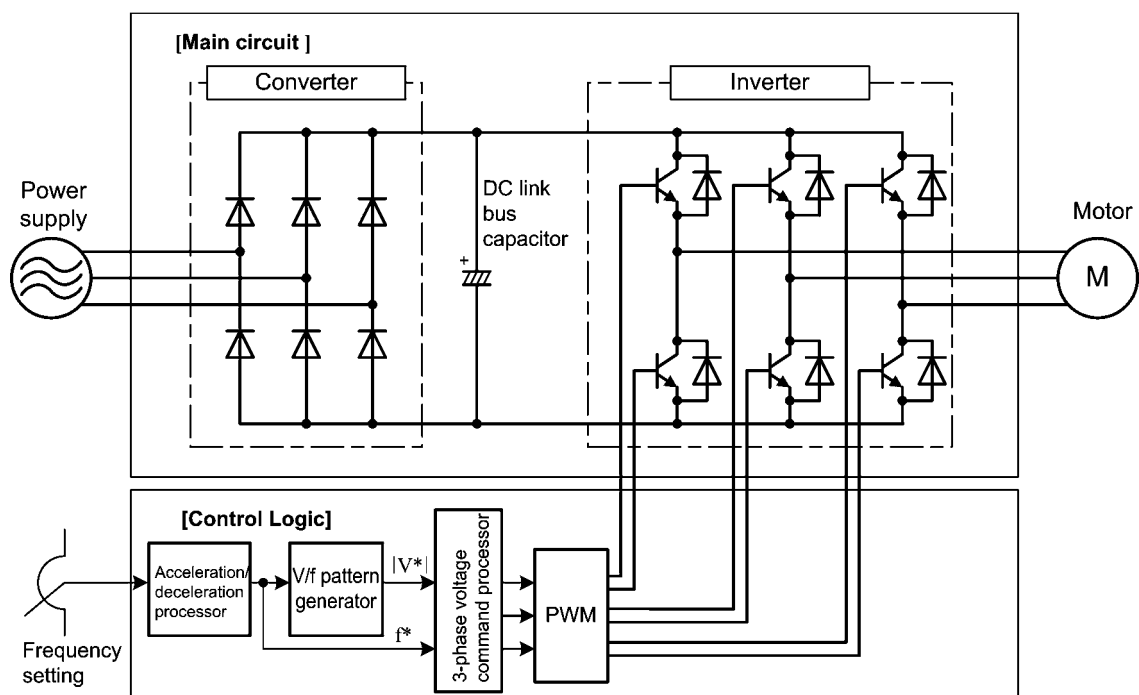

Figure 1.8 Simplified Control System Diagram of FRENIC-Mini

1.3 Recommended Configuration

To control a motor with an inverter correctly, you should consider the rated capacity of both the motor and the inverter and ensure that the combination matches the specifications of the machine or system to be used. Refer to Chapter 7, "SELECTING OPTIMAL MOTOR AND INVERTER CAPACITIES" for details.

After selecting the rated capacity, select appropriate peripheral equipment for the inverter, then connect them to the inverter.

 Refer to Chapter 6, "SELECTING PERIPHERAL EQUIPMENT" and Chapter 8, Section 8.7 "Connection Diagrams" for details on the selection and connection of peripheral equipment.

Figure 1.9 shows the recommended configuration for an inverter and peripheral equipment.

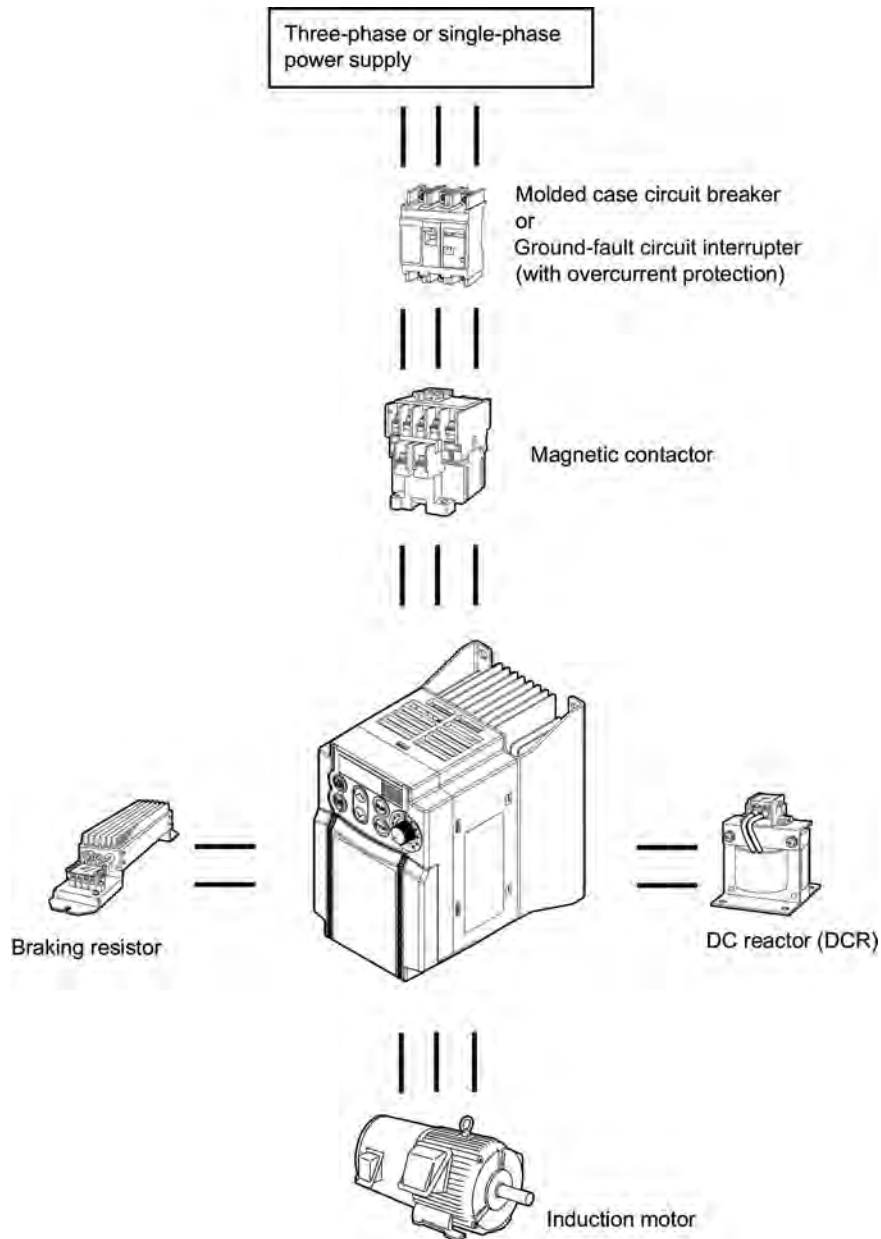

Figure 1.9 Recommended Configuration Diagram

Chapter 2

PARTS NAMES AND FUNCTIONS

This chapter contains external views of the FRENIC-Mini series and an overview of terminal blocks, including a description of the 7-segment LED monitor and keys on the keypad.

Contents

2.1	External View and Allocation of Terminal Blocks.....	2-1
2.2	LED Monitor, Potentiometer and Keys on the Keypad.....	2-2

2.1 External View and Allocation of Terminal Blocks

Figures 2.1 and 2.2 show the external and bottom views of the FRENIC-Mini.

(1) External and bottom views

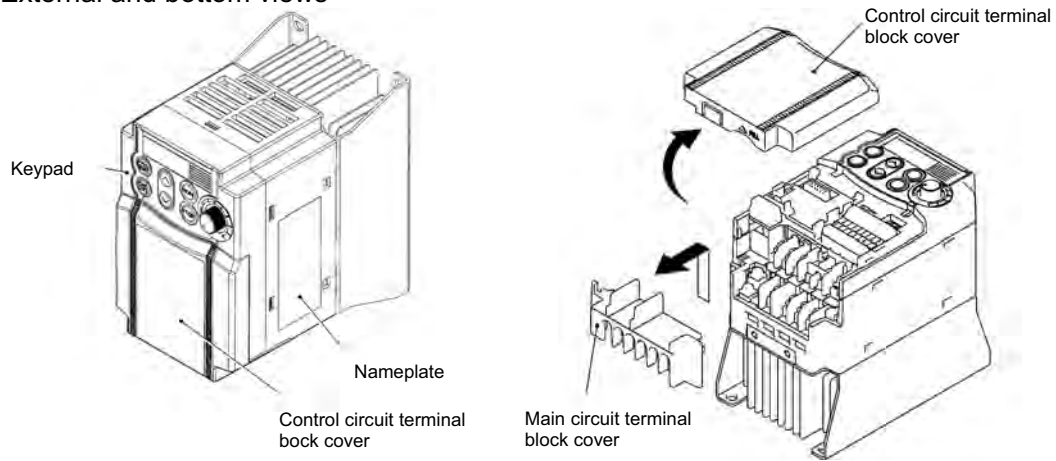
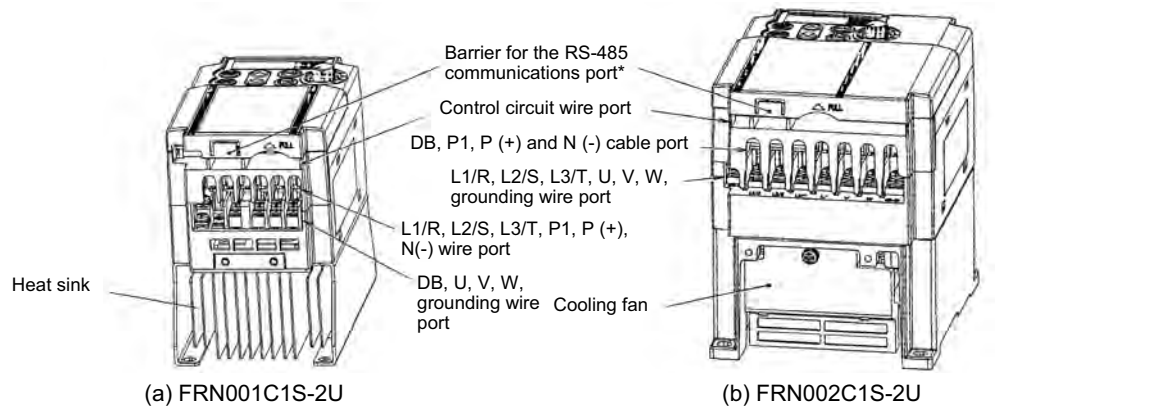

Figure 2.1 External Views of FRENIC-Mini



(*When connecting the RS-485 communications cable, remove the control circuit terminal block cover and snip off the barrier provided in it using nippers.)

Figure 2.2 Bottom View of FRENIC-Mini

(2) Allocation of terminals

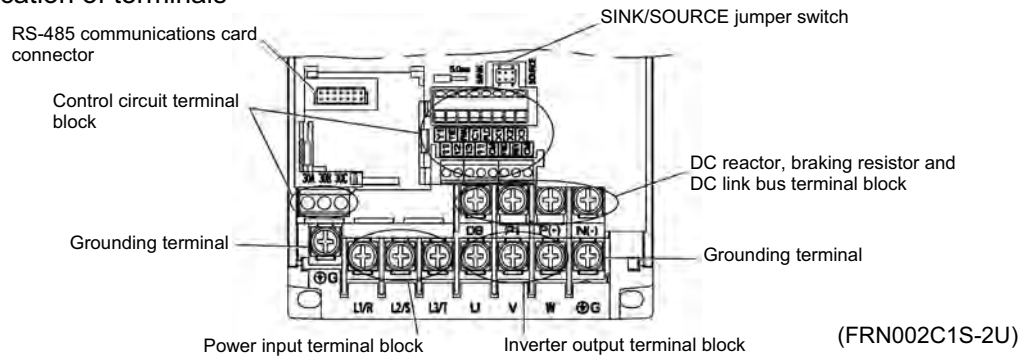

Figure 2.3 Enlarged View of the Terminal Blocks

The above figures show three-phase power source models. The terminal allocation of the power input terminals L1/R, L2/S, L3/T, and grounding terminals for single-phase models differs from that shown in above figures.

- 📖 Refer to Chapter 8 "SPECIFICATIONS" for details on terminal functions, allocation and connection and to Chapter 6, Section 6.2.1 "Recommended wires" when selecting wires.
- 📖 For details on the keys and their functions, refer to Section 2.2 "LED Monitor, Potentiometer and Keys on the Keypad." For details on keying operation and function code setting, refer to Chapter 3 "OPERATION USING THE KEYPAD."

2.2 LED Monitor, Potentiometer and Keys on the Keypad

As shown at the right, the keypad consists of a 7-segment LED monitor, a potentiometer (POT), and six keys.

The keypad allows you to run and stop the motor, monitor running status, and switch to the menu mode. In the menu mode, you can set the function code data to match your operating requirements and monitor I/O signal states, maintenance information, and alarm information.

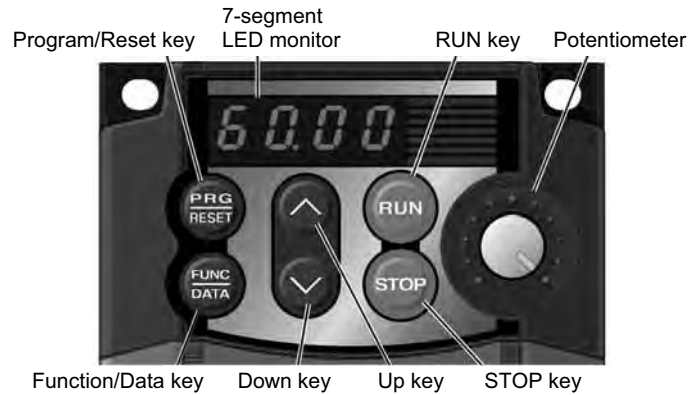

Figure 2.4 Keypad

Table 2.1 Overview of Keypad Functions

Monitor, Potentiometer and Keys	Functions
	Four-digit, 7-segment LED monitor which displays the running status, data settings, and alarm status of the inverter according to the operation modes*. In Running mode, the monitor displays running status information (e.g., output frequency, current, and voltage). In Programming mode, it displays menus, function codes and their data. In Alarm mode, it displays an alarm code which identifies the error factor if the protective function is activated.
	Potentiometer (POT) which is used to manually set frequency, auxiliary frequencies 1 and 2 or PID process command.
	RUN key. Press this key to run the motor.
	STOP key. Press this key to stop the motor.
	UP/DOWN keys. Press these keys to select the setting items and change the function data displayed on the LED monitor.
	Program/Reset key. Press this key to switch the operation modes* of the inverter. Pressing this key in Running mode switches the inverter to Programming mode and vice versa. In Alarm mode, pressing this key after removing the error factor will switch the inverter to Running mode.
	Function/Data key. Pressing this key in Running mode switches the information displayed (output frequency (Hz), current (Amps) or voltage (V)). Pressing this key in Programming mode displays the function code and sets the data entered using ^/ v keys or the POT. Pressing this key in Alarm mode displays information concerning the alarm code currently displayed on the LED monitor.

* FRENIC-Mini features three operation modes--Running, Programming, and Alarm modes. Refer to Chapter 3, Section 3.1 "Overview of Operation Modes."

■ LED monitor

In Running mode, the LED monitor displays running status information (output frequency, current or voltage); in Programming mode, it displays menus, function codes and their data; in Alarm mode, it displays an alarm code which identifies the error factor if the protective function is activated.

If one of LED4 through LED1 is blinking, it means that the cursor is at this digit, allowing you to change it.

If the decimal point of LED1 is blinking, it means that the currently displayed data is a PID process command, not the frequency data usually displayed.

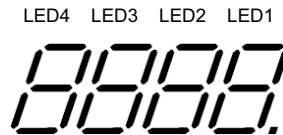

Figure 2.5 7-Segment LED Monitor

Table 2.2 Alphanumeric Characters on the LED Monitor

Character	7-segment	Character	7-segment	Character	7-segment	Character	7-segment
0		9		i		r	
1		A		J		S	
2		b		K		T	
3		C		L		u	
4		d		M		V	
5		E		n		W	
6		F		o		X	
7		G		P		y	
8		H		q		Z	
Special characters and symbols (numbers with decimal point, minus and underline)							
0. - 9.		-		_			

■ Repeat function of / keys

/ keys have a repeat function which helps you change displayed data speedily as follows:

Usually you press / keys once to increase or decrease the displayed value by 1, respectively.





If you hold down either key so as to activate the repeat function, the displayed value will keep changing in steps of 1 speedily. Note that when changing some function code data during running of the inverter (not always possible), the displayed data will keep changing more slowly. This is to ensure safe and stable operation.







■ Continuous holding-down function for Program/Reset  key

Holding down the  key longer (approx. one second or longer) moves the cursor on the LED monitor. In Running mode, the cursor moves along digits; in Programming mode, it moves not only along digits but to the next function code.

■ Simultaneous keying

Simultaneous keying means depressing two keys at the same time (expressed by "+"). FRENIC-Mini supports simultaneous keying as listed below.

(For example, the expression " +  keys" stands for pressing the  key while holding down the  key.)

Operation modes	Simultaneous keying	Used to:
Running mode	 +  keys	Control entry to/exit from jogging operation.
Programming mode	 +  keys	Change special function code data. (Refer to codes F00 and H03 in Chapter 9 "FUNCTION CODES.")
Alarm mode	 +  keys	Switch to Programming mode.

Chapter 3

OPERATION USING THE KEYPAD

This chapter describes inverter operation using the keypad. The inverter features three operation modes (Running, Programming and Alarm modes) which enable you to run and stop the motor, monitor running status, set function code data, display running information required for maintenance, and display alarm data.

Contents

3.1	Overview of Operation Modes.....	3-1
3.2	Running Mode	3-3
3.2.1	Run/stop the motor.....	3-3
3.2.2	Set up the set frequency and others.....	3-3
3.2.3	Monitor the running status	3-5
3.2.4	Jog (inch) the motor	3-7
3.3	Programming Mode	3-8
3.3.1	Setting the function codes--"Data Setting".....	3-9
3.3.2	Checking changed function codes--"Data Checking"	3-13
3.3.3	Monitoring the running status--"Drive Monitoring"	3-14
3.3.4	Checking I/O signal status--"I/O Checking"	3-17
3.3.5	Reading maintenance information--"Maintenance Information"	3-21
3.3.6	Reading alarm information--"Alarm Information".....	3-22
3.4	Alarm Mode	3-26
3.4.1	Releasing the alarm and transferring the inverter to Running mode	3-26
3.4.2	Displaying the alarm history	3-26
3.4.3	Displaying the running information when an alarm occurs	3-27
3.4.4	Transferring to Programming mode	3-27

3.1 Overview of Operation Modes

FRENIC-Mini features the following three operation modes:

- **Running mode** : This mode allows you to enter run/stop commands in regular operation. You may also monitor the running status in realtime.
- **Programming mode** : This mode allows you to set function code data and check a variety of information relating to the inverter status and maintenance.
- **Alarm mode** : If an alarm occurs, the inverter automatically enters this Alarm mode in which the corresponding alarm code* and its related information may be displayed on the LED monitor.

* Alarm code: Shows the error factor that has activated the protective function. For details, refer to Chapter 8, Section 8.8 "Details of Protective Functions."

Figure 3.1 shows the status transition of the inverter between these three operation modes. If the inverter is turned ON, it automatically enters Running mode, making it possible to start or stop the motor.

To make the transition between those operation modes, you need to press the specified keys as shown below, except at the occurrence of an alarm. If an alarm occurs in Running mode, the inverter will automatically switch to Alarm mode.

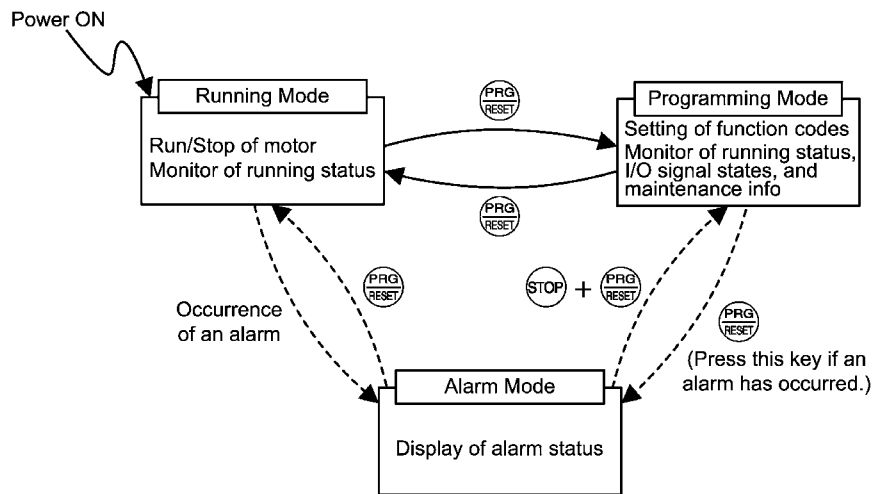
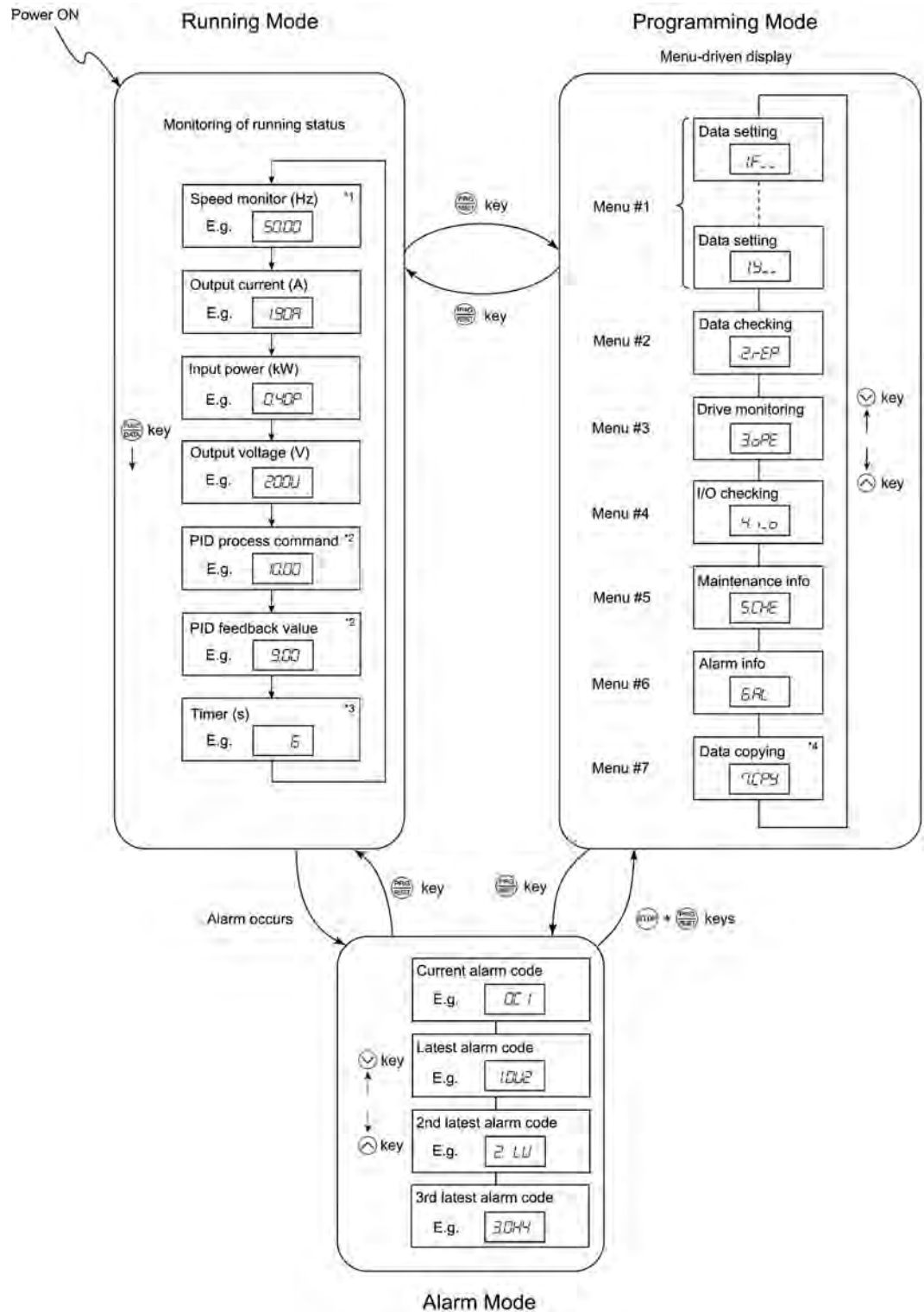

Figure 3.1 Status Transition between Operation Modes

The figure below shows the transition between the running status monitoring screens in Running mode, that between the menu screens in Programming mode, and that between the alarm code screens in Alarm mode.



- *1 The speed monitor may display the output frequency (Hz), set frequency (Hz), load shaft speed (r/min), line speed [ft/min. (m/min.)], and constant feeding rate time (min.) which can be selected by setting up function code E48.
- *2 These PID-related information will appear only when the inverter is under the PID control. (Refer to Section 3.2.2.)
- *3 This will appear only when timer operation is enabled by setting up function code C21. (Refer to Chapter 9, Section 9.2.3 "C codes (Control functions of frequency).")
- *4 This will appear only when the remote keypad (option) is set up for use.



Figure 3.2 Basic Screen Transition in Each Operation Mode



3.2 Running Mode

If the inverter is turned ON, it automatically enters Running mode in which you may:



- (1) Run/stop the motor
- (2) Set up the set frequency and others
- (3) Monitor the running status (e.g., output frequency, output current)
- (4) Jog (inch) the motor

3.2.1 Run/stop the motor

By factory default, pressing the  key starts running the motor in the forward direction and pressing the  key brings the motor to a decelerated stop. The  key is enabled only in Running mode.

Changing function code F02 data makes it possible to run the motor in the reverse direction by pressing the  key, determine the motor rotational direction by entering input signals to the terminals, and control the motor by pressing  /  keys.



3.2.2 Set up the set frequency and others





By using the potentiometer and  /  keys on the keypad, you may set up the desired set frequency and PID process commands. It is also possible to set up the set frequency as frequency, load shaft speed, line speed, and constant feeding rate time by setting function code E48.

Setting up the set frequency with the potentiometer on the keypad (factory default)



If you set function code F01 to "4: Potentiometer on the keypad" (factory default) and select frequency setting-1 with function codes E01 through E03 (Hz2/Hz1 = OFF), then the potentiometer becomes enabled to set up the set frequency. Setting function code C30 to "4: Potentiometer on the keypad" and selecting frequency setting-2 (Hz2/Hz1 = ON) also produce the same effect.

Setting up the set frequency with / keys

If you set function code F01 to "0: Keypad operation" and select frequency setting-1, then  /  keys become enabled to set up the set frequency in Running mode. In any other operation modes, those keys remain disabled.



Pressing  /  keys calls up the set frequency with the lowest digit blinking. Pressing  /  keys again makes it possible to change the set frequency. The new setting will be saved internally. Even if the inverter is switched to any other frequency entry method and then returned to the keypad entry method, the setting will be retained.

Further, even turning OFF the inverter will automatically save the setting into the non-volatile memory. At the next time when the inverter is turned ON, the setting will become the default frequency.

If you set function code F01 to "0: Keypad operation" but do not select frequency setting-1, then  /  keys cannot be used for setting up the set frequency. Pressing those keys will just display the currently selected set frequency.





To set up the set frequency from any other displayed items, it is dependent on function code E48 data (= 4, 5, or 6) "LED monitor details (Select speed monitor)" as listed in the following table.

E48 data "LED monitor details (Select speed monitor)"	Set frequency display	Conversion of displayed value
0: Output frequency (before slip compensation)	Frequency setting	
1: Output frequency (after slip compensation)	Frequency setting	
2: Set frequency	Frequency setting	
4: Load shaft speed	Load shaft speed setting	Frequency setting x E50
5: Line speed	Line speed setting	Frequency setting x E50
6: Constant feeding rate time	Constant feeding rate time	$\frac{E50}{\text{Frequency setting} \times E39}$

 If you set function code C30 to "0: Keypad operation" and select frequency setting-2, then  /  keys become also enabled to set up the set frequency.

■ Make setting under PID control

To enable PID control, you need to set function code J01 to 1 or 2.



In the PID control mode, the items that can be set or checked with  /  keys are different from those under normal frequency control, depending upon the current LED monitor setting. If the LED monitor is set to the speed monitor (E43 = 0), you may access manual feed commands (Set frequency) with  /  keys; if it is set to any other, you may access PID process commands with those keys.





 Refer to Chapter 4, Section 4.8 "PID Frequency Command Generator" for details on the PID control.

Setting the PID process command with the built-in potentiometer

Set function code E60 to "3: PID process command 1" and J02 to "1: PID process command 1." After that, selecting PID control remote process command enables you to set the PID process command using the built-in potentiometer.



Setting the PID process command with / keys

Set function code J02 to "0: Keypad operation" and set the LED monitor to the setting other than the speed monitor (E43 = 0) in Running mode. This makes it possible to set the PID process command using  /  keys. This setting is possible only in Running mode.

Pressing  /  keys displays the PID process command with the lowest digit blinking on the LED monitor. Pressing  /  keys again makes it possible to change the PID process command. Once the PID process command is modified, it will be saved internally. Even if the inverter is switched to any other PID process command entry method and then returned to the keypad entry method, the setting will be retained.

Further, even turning OFF the inverter will automatically save the setting into the non-volatile memory. At the next time when the inverter is turned ON, the setting will become the default PID process command.

Even if the PID process command is selected ((SS4) = ON) in the multistep frequency, it is still possible to set the process command using the keypad.

When function code J02 has been set to any value except 0, pressing  /  keys displays the PID process command currently selected (setting is not possible).

When the PID process command is displayed, the decimal point next to the lowest digit on the LED display blinks to discriminate it from the frequency setting.

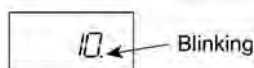

Setting up the set frequency with \wedge / \vee keys under the PID control

To set the set frequency with \wedge / \vee keys under the PID control, you need to specify the following conditions:

- Set function code F01 to "0: Keypad operation."
- Select frequency setting-1 (Frequency settings from communications link: Disabled, and Multistep frequency settings: Disabled) as manual speed command.
- Set the LED monitor to the speed monitor in Running mode.

The above setting is impossible in any operation mode except Running mode.

The setting procedure is the same as that for usual frequency setting.

If you press \wedge / \vee keys in any conditions other than those described above, the following will appear:

Frequency setting 1 (F01)	Frequency setting from communications link	Multistep frequency setting	PID control cancelled	Displayed using \wedge / \vee keys
0	Disabled	Disabled	PID enabled	Frequency setting by keypad
			Cancelled	
Other than the above			PID enabled	PID output (as final frequency command)
			Cancelled	Manual speed command currently selected (frequency setting)



- When setting the frequency and others with \wedge / \vee keys, the lowest digit on the display will blink. Change the setting, starting from the lowest digit and the cursor will move gradually to the next digit to be changed.
- When the data is to be changed rapidly, hold down the PRG/RES key for 1 second or longer, and the blinking cursor will move to the next digit where the data can be changed (cursor movement).

3.2.3 Monitor the running status

In Running mode, the seven items listed below can be monitored. Immediately after the inverter is turned ON, the monitor item specified by function code E43 is displayed. Press the FUNC/DATA key to switch between monitor items.

Table 3.1 Monitor Items

Monitor Items	Display Sample on the LED monitor	Meaning of Displayed Value
Speed monitor [Hz, r/min, ft/min (m/min), min]	50.00	Refer to Table 3.2.
Output current (A)	1.90A	Detected value
Input power (HP)	0.40P	P: An alternative expression for kW
Output voltage (V)	200V	Commanded value
PID process command (Note)	10.00	(PID process command or PID feedback value) \times (PID display coefficient A – B) + B
PID feedback value (Note)	9.00	
Timer (sec) (Note)	6	Remaining effective timer count

Note: The PID process command and PID feedback value are displayed only under the PID control using a process command (J01 = 1 or 2). Further, the timer (for timer operation) is only displayed when timer is enabled (C21 = 1).

Figure 3.3 shows the procedure example for selecting the desired monitor item.

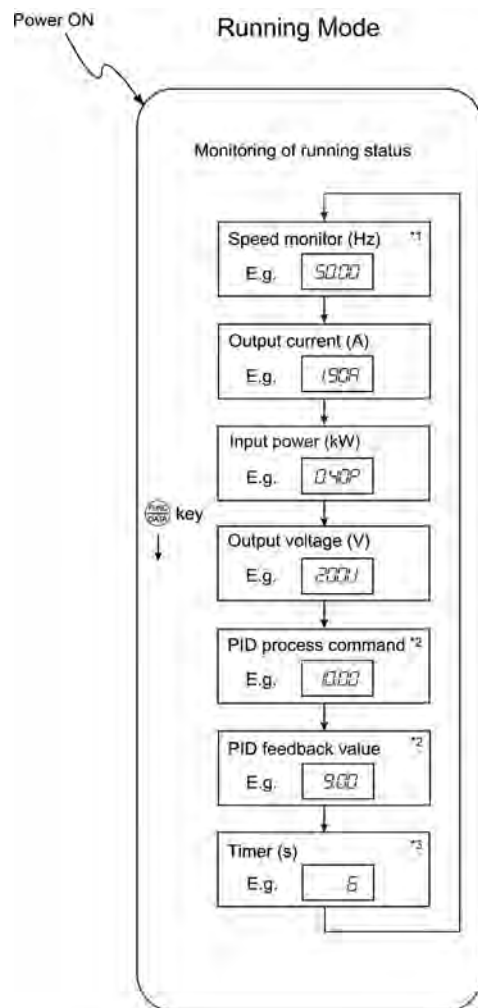

- *1 The speed monitor may display the output frequency (Hz), set frequency (Hz), load shaft speed (r/min), line speed [ft/min. (m/min.)], and contrast feeding rate time (min.) which can be selected by setting up function code E48.
- *2 These PID-related information will appear only when the inverter is under the PID control. (Refer to Section 3.2.2.)
- *3 This will appear only when timer operation is enabled by setting up function code C21. (Refer to Chapter 9, Section 9.2.3 "C codes (Control functions of frequency).")

Figure 3.3 Monitor Item Selection Example



Table 3.2 lists the display items for the speed monitor that can be chosen with function code E48.



Table 3.2 Display Items on the Speed Monitor

Speed monitor items	Function code E48 data	Meaning of Displayed Value
Output frequency (before slip compensation) (Hz) (Factory default)	0	Pre-slip compensation frequency
Output frequency (after slip compensation) (Hz)	1	Frequency actually being outputted
Set frequency (Hz)	2	Final set frequency
Load shaft speed (r/min)	4	Display value = Output frequency (Hz) x E50*
Line speed [ft/min (m/min)]	5	Display value = Output frequency (Hz) x E50*
Constant feeding rate time (min)	6	Display value = $\frac{E50}{\text{Output frequency} \times E39}$ *

* Output frequencies contained in these formulas are output frequencies before slip compensation.

3.2.4 Jog (inch) the motor



In Running mode, pressing  +  keys at the same time (simultaneous keying) can make the inverter ready for jogging. The *JoG* appears on the LED monitor.



To return the inverter from the ready-to-jog state to the usual running state, you need to press  +  keys simultaneously.

Using the external input signal command (JOG) also allows the transition between the ready-to-jog state and usual running state.

 Refer to function codes E01 to E03 in Chapter 9, Section 9.2.2 "E codes (Extension terminal functions)" for details.

During jogging, the jogging frequency (C20) and acceleration/deceleration time for jogging (H54) will apply. They are exclusively prepared for jogging and required to be set up individually.

When jogging the motor from the keypad, the inverter will only run while the  key is held down, and contrarily the moment the  key is released, the inverter will decelerate and stop the motor.

 The transition ( +  keys) between the ready-to-jog state and usual running state is enabled only when the inverter is not in operation.

3.3 Programming Mode

Pressing the  key in Running mode switches the inverter to Programming mode. This mode provides the following functions which can be easily selected with the menu-driven system.

- (1) Data setting (Menu #1)
- (2) Data checking (Menu #2)
- (3) Drive monitoring (Menu #3)
- (4) I/O checking (Menu #4)
- (5) Maintenance information (Menu #5)
- (6) Alarm information (Menu #6)
- (7) Data copying (Menu #7)

The table below lists the menus, letters that will appear on the LED monitor, and functions. The leftmost digit (numerals) of each letter string indicates the corresponding menu number and the remaining three digits indicate the menu contents.

When the inverter enters Programming mode from the second time on, the menu that was selected last in Programming mode will be displayed.

Table 3.3 Menus Available in Programming Mode

Menu	LED monitor shows:	Main functions	Refer to:
Menu #1 "Data setting"	1. F _ _	F codes (Fundamental functions)	Selecting each of these function codes enables its data to be displayed/changed.
	1. E _ _	E codes (Extension terminal functions)	
	1. C _ _	C codes (Control functions of frequency)	
	1. P _ _	P codes (Motor parameters)	
	1. H _ _	H codes (High performance functions)	
	1. U _ _	J codes (Application functions)	
	1. Y _ _	y codes (Link functions)	
Menu #2 "Data checking"	2. rEP	Displays only function codes that have been changed from their factory defaults. You may refer to or change those function codes data.	Section 3.3.2
Menu #3 "Drive monitoring"	3. oPE	Displays the running information required for maintenance or test running.	Section 3.3.3
Menu #4 "I/O checking"	4. I _ O	Displays external I/O signal information.	Section 3.3.4
Menu #5 "Maintenance information"	5. CHE	Displays maintenance information including cumulative running time.	Section 3.3.5
Menu #6 "Alarm information"	6. AL	Displays the latest four alarm codes. You may refer to the running information at the time when the alarm occurred.	Section 3.3.6
Menu #7 "Data copying"	7. CPY	Allows you to read or write function code data, as well as verifying it. NOTE: To use this function, a remote keypad (option) is necessary.	

Limiting menus to be displayed

The menu-driven system has a limiter function (specified by function code E52) that limits menus to be displayed for the purpose of simple operation. The factory default is to display Menu #1 "Data setting" only, allowing no switching to any other menu.

Function Code E52 – Keypad (Mode Selection)

Function code data (E52)	Menus selectable
0: Function code data setting mode	Menu #1 "Data setting" (factory default)
1: Function code data check mode	Menu #2 "Data checking"
2: Full-menu mode	Menu #1 through #6 (#7*)

* Menu #7 appears only when the remote keypad (option) is set up for use.



If the full-menu mode is selected, pressing the \wedge / \vee keys will cycle through menus. With the $\text{\textcircled{FUNC DATA}}$ key, you may select the desired menu. Once all of the menus have been cycled through, the display will return to the first menu.

3.3.1 Setting the function codes--"Data Setting"

Menu #1 "Data setting" in Programming mode allows you to set function codes for making the inverter functions match your needs.

The table below lists the function codes available in the FRENIC-Mini. The function codes are displayed on the LED monitor on the keypad as shown below.

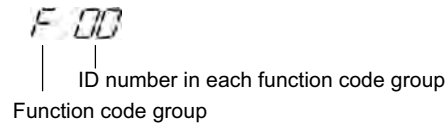

Table 3.4 List of FRENIC-Mini Function Codes

Function code group	Function code	Function	Description
F codes (Fundamental functions)	F00 to F51	Basic functions	To be used for basic motor running.
E codes (Extension terminal functions)	E01 to E99	Terminal functions	To be used to select the functions of the control circuit terminals. To be used to set functions related to the LED monitor display.
C codes (Control functions of frequency)	C01 to C52	Control functions	To be used to set application functions related to frequency settings.
P codes (Motor parameters)	P02 to P99	Motor parameters	To be used to set specific parameters for the motor capacity, etc.
H codes (High performance functions)	H03 to H98	High level functions	To be used for high added value functions and complicated control, etc.
J codes (Application functions)	J01 to J06	Application functions	To be used for PID control.
y codes (Link functions)	y01 to y99	Link functions	To be used for communications.



Refer to Chapter 9 "FUNCTION CODES" for details on the function codes.

Function codes that require simultaneous keying

To change data for function codes F00 (Data Protection) and H03 (Data Initialization), simultaneous keying operation is necessary--(STOP) + (∧) keys or (STOP) + (∨) keys. This prevents data from being lost by mistake.

Changing, validating, and saving of function code data during running

Some function code data can be changed while the motor is running and some cannot. Further, amongst the function codes whose data can be changed while the motor is running, there are some for which the changes can be validated immediately and others for which they cannot. Refer to the "Change when running" column in Chapter 9, Section 9.1 "Function Code Tables."

Figure 3.4 shows the status transition for Menu #1 "Data setting" and Figure 3.5 shows an example of the function code data changing procedure.

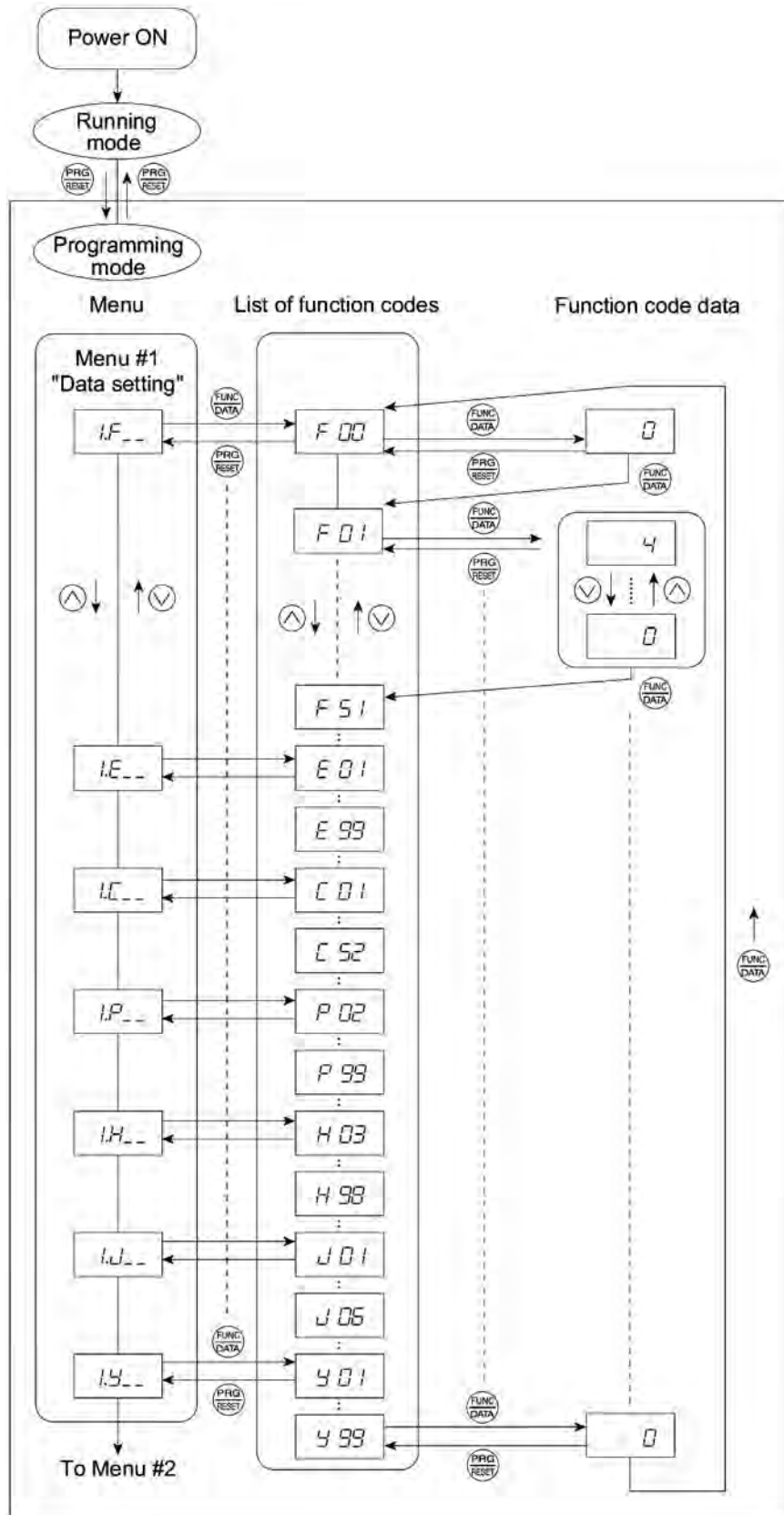

Figure 3.4 Status Transition Diagram for "Data Setting"

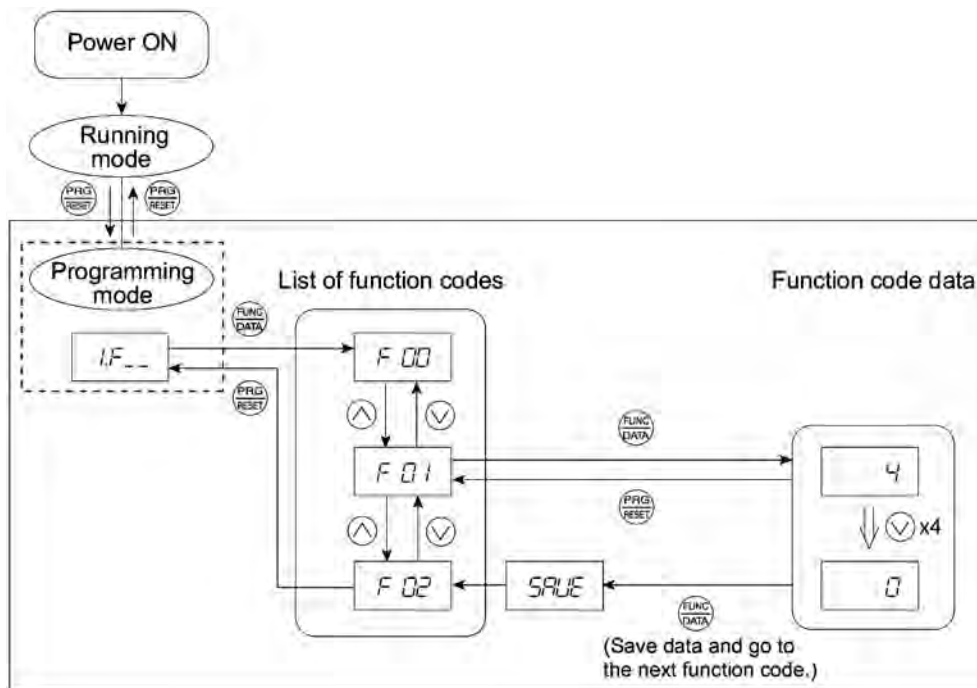

Figure 3.5 Example of Function Code Data Changing Procedure

Basic key operation

This section will give a description of the basic key operation, following the example of the function code data changing procedure shown in Figure 3.5.

This example shows you how to change function code F01 data from the factory default of "Potentiometer operation on the keypad (F01 = 4)" to "Ⓐ/Ⓢ keys operation (F01 = 0)."

- (1) With the menu displayed, use Ⓐ/Ⓢ keys to select the desired function code group. (In this example, select *i.F__*).
- (2) Press the **FUNC/DATA** key to display the function codes in the function code group selected in (1). (In this example, function code *F00* will appear.)

Even if the function code list for a particular function code group is displayed, it is possible to transfer the display to a different function code group using Ⓐ/Ⓢ keys.

- (3) Select the desired function code using Ⓐ/Ⓢ keys and press the **FUNC/DATA** key. (In this example, select function code *F01*.)

The data of this function code will appear. (In this example, data *4* of *F01* will appear.)

- (4) Change the function code data using Ⓐ/Ⓢ keys. (In this example, press the Ⓢ key four times to change data from *4* to *0*.)
- (5) Press the **FUNC/DATA** key to establish the function code data.

The **SAVE** will appear and the data will be saved in the non-volatile memory. The display will return to the function code list, then move to the next function code. (In this example, *F02*.)

Pressing the **PRG/RESET** key before the **FUNC/DATA** key cancels the change made to the data. The data reverts to the previous value, the display returns to the function code list, and the original function code reappears.

- (6) Press the **PRG/RESET** key to return to the menu from the function code list.

Tip Cursor movement: You may move the cursor when changing function code data in the same way as with the frequency settings. Refer to Section 3.2.2 "Set up the set frequency and others."

3.3.2 Checking changed function codes--"Data Checking"

Menu #2 "Data checking" in Programming mode allows you to check function code data that have been changed. Only data that has been changed from the factory defaults are displayed on the LED monitor. You may refer to the function code data and change again if necessary. Figure 3.6 shows the status transition diagram for "Data checking."

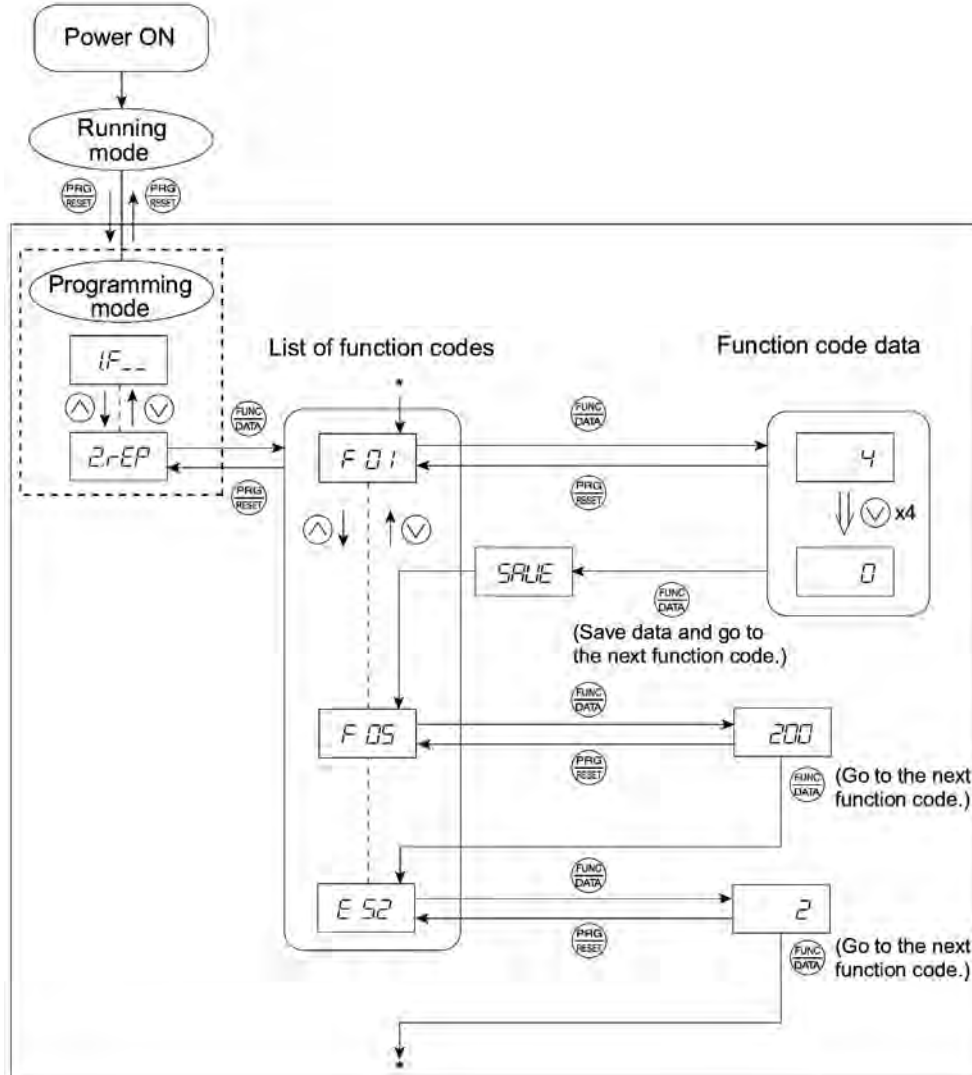

* Pressing the key when the E52 data is displayed will take you back to F01.

Figure 3.6 Data Checking Status Transition Diagram (Changes made only to F01, F05, E52)

Basic key operation

The basic key operation is the same as for Menu #2 "Data setting."

To monitor Menu #2 "Data checking," it is necessary to set function code E52 data to 1 (Function code data check mode) or 2 (Full-menu mode).

3.3.3 Monitoring the running status--"Drive Monitoring"

Menu #3 "Drive monitoring" is used to check the running status during maintenance and test running. The display items for "Drive monitoring" are listed in Table 3.5. Using keys, you may check those items in succession. Figure 3.7 shows the status transition diagram for "Drive monitoring."

Table 3.5 Drive Monitoring Display Items

LED monitor shows:	Contents	Unit	Description
3.00	Output frequency	Hz	Output frequency before slip compensation
3.01	Output frequency	Hz	Output frequency after slip compensation
3.02	Output current	A	Present output current
3.03	Output voltage	V	Present output voltage
3.05	Set frequency	Hz	Present set frequency
3.06	Rotational direction	N/A	Displays the rotational direction specified by a run command being outputted. F: forward; r: reverse, - - - -: stop
3.07	Running status	N/A	Displays the running status in hex. format. Refer to "Displaying running status" on the page 3-16.
3.09	Load shaft speed (line speed)	r/min (m/min)	The unit for load shaft speed is r/min and that for line speed is m/min. Display value = (Output frequency Hz before slip compensation) × (Function code E50) E 3 is displayed for 10000 (r/min or m/min) or more. When E 3 is displayed, the data is overflowing, which means that the function code should be reviewed. For example: Load shaft speed = Displayed data × 10 (r/min)
3.10	PID process commands	N/A	These commands are displayed through the use of function code E40 and E41 (PID display coefficient A and B). Display value = (PID process command) × (PID display coefficient A - B) + B If PID control is disabled, "- - -" appears.
3.11	PID feedback value	N/A	This value is displayed through the use of function code E40 and function code E41 (PID display coefficient A and B). Display value = (PID feedback value) × (PID display coefficient A - B) + B If PID control is disabled, "- - -" appears.

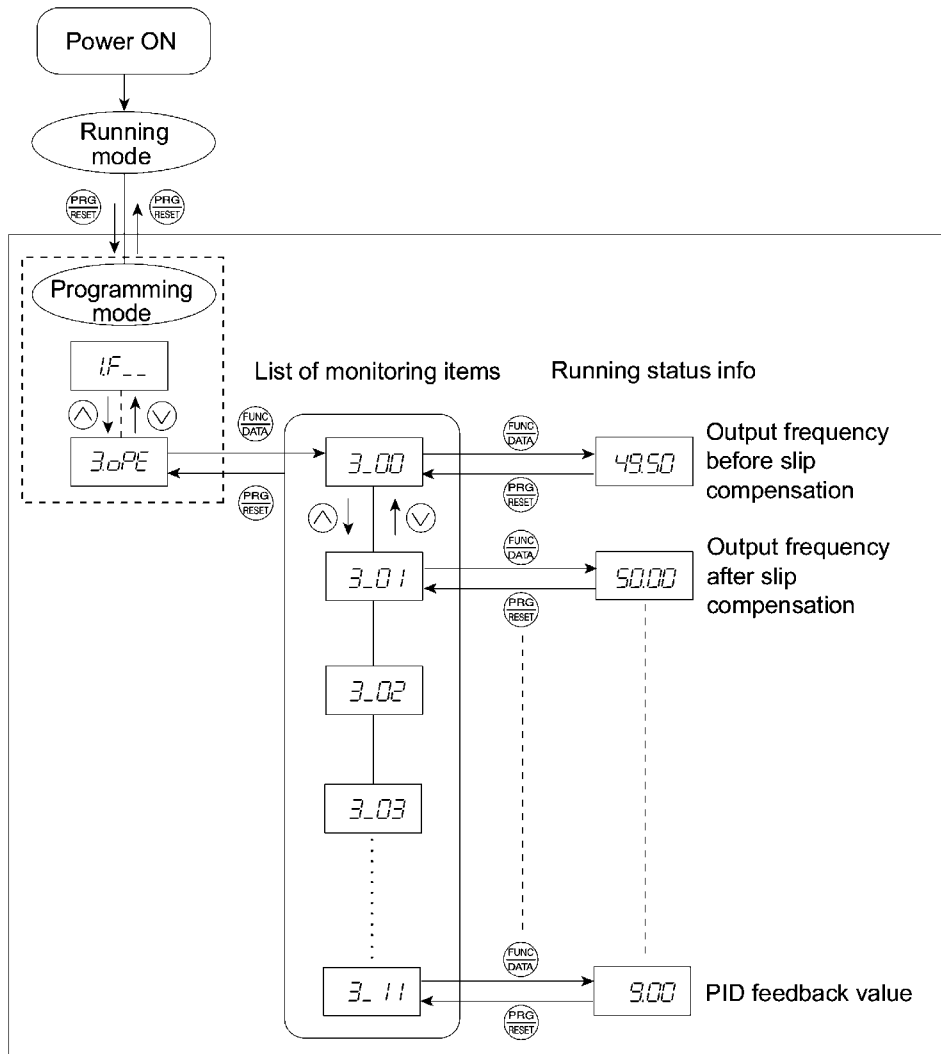

Figure 3.7 Drive Monitoring Status Transition

Basic key operation

- (1) With the menu displayed, use Δ / ∇ keys to select "Drive monitoring" ($3.0PE$).
- (2) Press the FUNC/DATA key to display the desired code in the monitoring items list (e.g. 3.00).
- (3) Use Δ / ∇ keys to select the desired monitoring item, then press the FUNC/DATA key.
The running status information for the selected item will appear.
- (4) Press the PRG/RESET key to return to the monitoring items list. Press the PRG/RESET key again to return to the menu.

Tip If the menu cannot switch to any other one, set function code E52 to 2 (Full-menu mode).

Displaying running status

To display the running status in hexadecimal format, each state has been assigned to bit 0 to 15 as listed in Table 3.6. Table 3.7 shows the relationship between each of the status assignments and the LED monitor display. Table 3.8 gives the conversion table from 4-bit binary to hexadecimal.

Table 3.6 Running Status Bit Allocation

Bit	Notation	Content
15	BUSY	1 when function code data is being written.
14	WR	Always 0.
13		Always 0.
12	RL	1 when communications is effective (when run commands and set frequencies commands are issued via communications).
11	ALM	1 when an alarm has occurred.
10	DEC	1 during deceleration.
9	ACC	1 during acceleration.
8	IL	1 during current limitation.
7	VL	1 under voltage control.
6	TL	Always 0.
5	NUV	1 when DC link bus voltage has increased up to the specified level (0 for undervoltage).
4	BRK	Always 0.
3	INT	1 when the inverter output is shut down.
2	EXT	1 during DC braking.
1	REV	1 during running in the reverse direction.
0	FWD	1 during running in the forward direction.

Table 3.7 Running Status Display

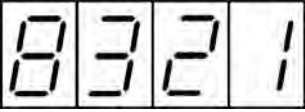
LED No.		LED4				LED3				LED2				LED1			
Bit		15	14	13	12	11	10	9	8	7	6	5	4	3	2	1	0
Notation		BUSY	WR		RL	ALM	DEC	ACC	IL	VL	TL	NUV	BRK	INT	EXT	REV	FWD
Example	Binary	1	0	0	0	0	0	1	1	0	0	1	0	0	0	0	1
	Hexa-decimal on the LED monitor	<div style="display: flex; justify-content: center; align-items: center; gap: 10px;"> LED4 LED3 LED2 LED1  </div>															

Hexadecimal expression

A 16-bit binary number is expressed in hexadecimal format (4 bits). Table 3.8 shows the expression corresponding to decimals. The hexadecimals are shown as they appear on the LED monitor.

Table 3.8 Binary and Hexadecimal Conversion

Binary				Hexadecimal	Decimal	Binary				Hexadecimal	Decimal
0	0	0	0	0	0	1	0	0	0	8	8
0	0	0	1	1	1	1	0	0	1	9	9
0	0	1	0	2	2	1	0	1	0	10	10
0	0	1	1	3	3	1	0	1	1	11	11
0	1	0	0	4	4	1	1	0	0	12	12
0	1	0	1	5	5	1	1	0	1	13	13
0	1	1	0	6	6	1	1	1	0	14	14
0	1	1	1	7	7	1	1	1	1	15	15

3.3.4 Checking I/O signal status--"I/O Checking"

With Menu #4 "I/O checking," you may display the status of external I/O signals without using a measuring instrument. External signals that can be displayed include digital I/O signals and analog I/O signals. Table 3.9 lists check items available. The status transition for I/O checking is shown in Figure 3.8.

Table 3.9 I/O Check Items

LED monitor shows:	Display contents	Description
4_00	I/O signals on the control circuit terminals	Shows the ON/OFF state of the digital I/O terminals. Refer to "[1] Displaying control I/O signal terminals" on page 3-19 for details on the display contents.
4_01	I/O signals on the control circuit terminals under communication control	Shows the ON/OFF state for the digital input terminals that received a command via RS-485 communications. Refer to "[1] Displaying control I/O signal terminals" on page 3-19 and "[2] Displaying control I/O signal terminals under communication control" on page 3-20 for details on the display contents.
4_02	Input voltage on terminal [12]	Shows the input voltage on terminal [12] in volts (V).
4_03	Input current on terminal [C1]	Shows the input current on terminal [C1] in milliamperes (mA).
4_04	Output voltage to analog meters [FMA]	Shows the output voltage on terminal [FMA] in volts (V).

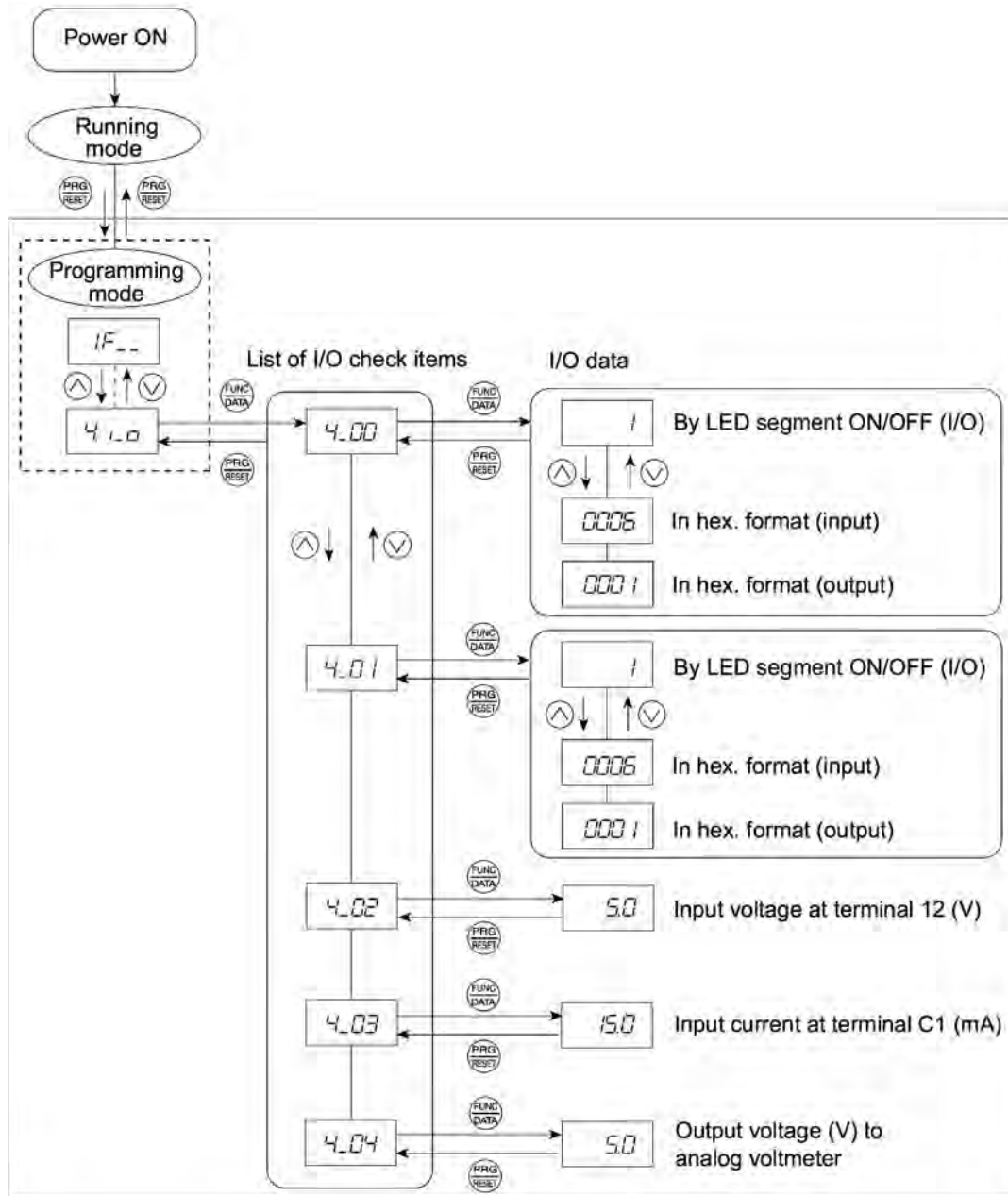

Figure 3.8 Status Transition of I/O Check

Basic key operation

- (1) With the menu displayed, use Δ / ∇ keys to select "I/O check" (4_00)
- (2) Press the FUNC/DATA key to display the codes for the I/O check item list. (e.g. 4_00)
- (3) Use Δ / ∇ keys to select the desired I/O check item, then press the FUNC/DATA key.

The corresponding I/O check data will appear. For control circuit I/O terminals, use Δ / ∇ keys to select one of the two different display methods.

- (4) Press the PRG/RESET key to return to the I/O check item list. Press the PRG/RESET key again to return to the menu.

Tip If the menu cannot switch to any other one, set function code E52 to 2 (Full-menu mode).

[1] Displaying control I/O signal terminals

The I/O signal status of control circuit terminals may be displayed with ON/OFF of the LED segment or in hexadecimal display.

■ Display I/O signal status with ON/OFF of the LED segment

As shown in Table 3.10 and the figure below, segments "a" to "e" on LED1 light when the digital input terminals ([FWD], [REV], [X1], [X2], and [X3]) are short-circuited (ON) with the terminal [CM] and do not light when they are opened (OFF). Segment "a" on LED3 lights when the circuit between output terminal [Y1] and terminal [Y1E] is closed (ON) and does not light when the circuit is open (OFF). LED4 is for terminals [30A], [30B], [30C]. Segment "a" on LED4 lights when the circuit between terminals [30C] and [30A] are short-circuited (ON) and does not light when they are opened.

Note This LED monitor displays hardware terminal information, which means that it may not light when it is in reverse logic (refer to Chapter 9 "FUNCTION CODES" for details), even when it is active.

Table 3.10 Segment Display for External Signal Information

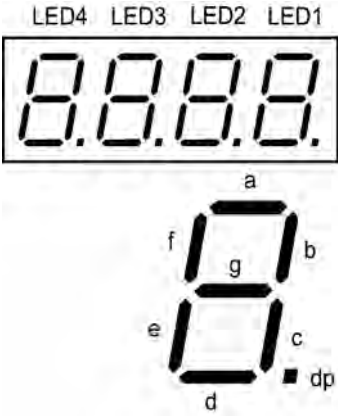

Segment	LED4	LED3	LED2	LED1
a	[30A/B/C]	[Y1]-[Y1E]	-	[FWD]-[CM] or [FWD]-[PLC] ^{*2}
b	-	-	-	[REV]-[CM] or [REV]-[PLC] ^{*2}
c	-	-	-	[X1]-[CM] or [X1]-[PLC] ^{*2}
d	-	-	-	[X2]-[CM] or [X2]-[PLC] ^{*2}
e	-	-	-	[X3]-[CM] or [X3]-[PLC] ^{*2}
f	-	-	(XF) ^{*1}	-
g	-	-	(XR) ^{*1}	-
dp	-	-	(RST) ^{*1}	-

- : No correlating control circuit terminals

^{*1} (XF), (XR), and (RST) are reserved for communications. Refer to "[2] Displaying control I/O signal terminals under communication control."

^{*2} Terminal [CM] if the jumper switch is set for a sink; terminal [PLC] if the jumper switch is set for a source.

■ Displaying I/O signal status in hexadecimal format

Each I/O terminal is assigned to bit 15 through bit 0 as listed in Table 3.11. An unassigned bit is interpreted as "0." Allocated bit data is displayed on the LED monitor in 4-digit hexadecimal ("0" to "F" each).

With the FRENIC-Mini, digital input terminals [FWD] and [REV] are assigned to bit 0 and bit 1, respectively. Terminals [X1] through [X3] are assigned to bits 2 through 4. The value "1" is set for each bit when the assigned input terminal is short-circuited (ON) with terminal [CM]. The value "0" when it opens (OFF). For example, when [FWD] and [X1] are ON and all others are OFF, the display on LED4 to LED1 would be 0005.

Bit 0 is assigned to digital output terminal [Y1]. The value "1" is set when the terminal is short-circuited with [Y1E], and the value "0" is set when it opens. The status of the mechanical relay contact output terminal [30A], [30B] and [30C] are assigned to bit 8. The value "1" is set when the circuit between output terminals [30A] and [30C] is closed and the value "0" when the circuit between [30B] and [30C] is closed. For example, if [Y1] is ON and the circuit between [30A] and [30C] are short-circuited with each other, then the display for LED4 to LED1 would be 0101.

How the hexadecimal display is configured for the terminals to which bits 0 to 15 are assigned and the 7-segment LED is shown below.

Table 3.11 Segment Display for I/O Signal Status in Hexadecimal Format

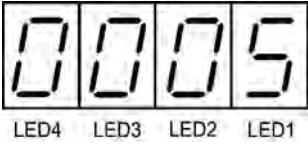
LED No.	LED4				LED3				LED2				LED1			
	15	14	13	12	11	10	9	8	7	6	5	4	3	2	1	0
Input terminal	(RST)*	(XR)*	(XF)*	-	-	-	-	-	-	-	-	[X3]	[X2]	[X1]	[REV]	[FWD]
Output terminal	-	-	-	-	-	-	-	[30A/C]	-	-	-	-	-	-	-	[Y1]
Example	Binary	0	0	0	0	0	0	0	0	0	0	0	0	1	0	1
	Hexadecimal on the LED monitor															

- : No correlating control terminals

* (XF), (XR), and (RST) are reserved for communications. Refer to "[2] Displaying control I/O signal terminals under communication control" below.

[2] Displaying control I/O signal terminals under communication control

There are two control circuit input displays under communications link control – "display with ON/OFF of the LED segment" and "in hexadecimal format" for input commanded from RS-485 communications link. The content is similar to that of the control circuit I/O signal terminal status display; however, (XF) and (XR) are added as inputs and nothing is assigned as output terminals.

 Refer to the RS-485 Communication User's Manual for details on command inputs through RS-485 communication.

3.3.5 Reading maintenance information--"Maintenance Information"

Menu #5 "Maintenance information" in Programming mode contains information necessary for performing maintenance on the inverter. Table 3.12 lists the maintenance information display items and Figure 3.9 shows the status transition for maintenance information.

Table 3.12 Maintenance Display Items

LED monitor shows:	Display contents	Description
5_00	Accumulated run time	Shows the accumulated power-ON time of the inverter. Unit: thousands of hours. When the total ON-time is less than 10,000 hours (display: 0.001 to 9.999), it is possible to check data in hourly units. When the total time is 10,000 hours or more (display: 10.00 to 65.53), the display will change to units of 10 hours. When the total time exceeds 65,535 hours, the display will be reset to 0 and the count will start again.
5_01	DC link bus voltage	Shows the DC link bus voltage of the inverter. Unit: V (volts)
5_03	Max. temperature of heat sink	Shows the maximum temperature of the heat sink for every hour. Unit: °C
5_04	Max. effective current	Shows the maximum effective current for every hour. Unit: A (amperes)
5_05	Capacitance of the DC link bus capacitor	Shows the current capacitance of the DC link bus capacitor, based on the capacitance when shipped as 100%. Refer to the FRENIC-Mini Instruction Manual, Chapter 7 "MAINTENANCE AND INSPECTION" for details. Unit: %
5_06	Accumulated run time of electrolytic capacitor on the printed circuit board/s	Shows the accumulated run time of the capacitor mounted on the printed circuit board/s. The display method is the same as for "Accumulated run time" above. However, when the total time exceeds 65,535 hours, the count stops and the display remains at 65.53.
5_07	Accumulated run time of the cooling fan	Shows the accumulated run time of the cooling fan. If the cooling fan ON/OFF control (function code H06) is effective, the time when the fan is stopped is not counted. The display method is the same as for "Accumulated run time" above. However, when the total time exceeds 65,535 hours, the count stops and the display remains at 65.53.
5_08	Number of startups	The motor run times (the number of times the inverter run command is set to ON) are calculated and displayed. 1.000 indicates 1,000 times. When any number ranging from 0.001 to 9.999 is displayed, the display increases by 0.001 per startup, and when any number from 10.00 to 65.53 is displayed, the display increases by 0.01 every 10 startups.
5_11	No. of RS-485 errors	Shows the total number of times RS-485 communications error has occurred after the power is turned ON. Once the number of errors exceeds 9.999, the display (count) returns to 0.
5_12	RS-485 error contents	Shows the latest error that has occurred with RS-485 communications in hexadecimal format. Refer to the RS-485 Communication User's Manual.
5_14	ROM version of inverter	Shows the ROM version of the inverter as a 4-digit display.
5_15	ROM version of keypad	Shows the ROM version of the keypad as a 4-digit display. (For remote keypad only.)

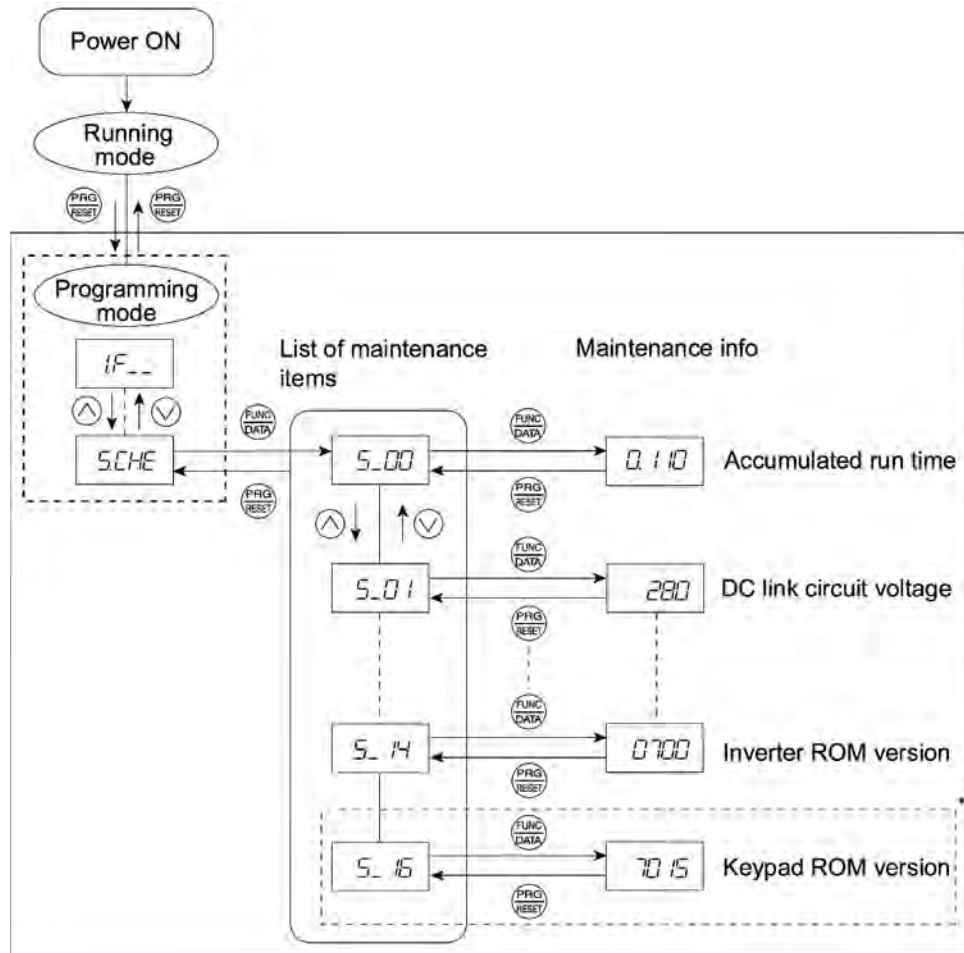

* The part in the dotted-line box is applicable only when a remote keypad is set up for operation.

Figure 3.9 Status Transition of Maintenance Information

Basic key operations

- (1) With the menu displayed, use Δ / ∇ keys to select "Maintenance information" (5.CHE).
- (2) Press the FUNC/DATA key to display the list of maintenance item codes (e.g. 5.00).
- (3) Use Δ / ∇ keys to select the desired maintenance item, then press the FUNC/DATA key.
The data of the corresponding maintenance item will appear.
- (4) Press the PRG/RESET key to return to the list of maintenance items. Press the PRG/RESET key again to return to the menu.

Tip If the menu cannot switch to any other one, set function code E52 to 2 (Full-menu mode).

3.3.6 Reading alarm information--"Alarm Information"

Menu #6 "Alarm information" in Programming mode shows the cause of the past 4 alarms as alarm codes. Further, it is also possible to display alarm information that indicates the status of the inverter when the alarm occurred. Table 3.13 shows the contents of the alarm information and Figure 3.10 shows the status transition of the alarm information.

Table 3.13 Alarm Information Contents

LED monitor shows: (Item No.)	Display contents	Description
<i>E_00</i>	Output frequency	Output frequency before slip compensation
<i>E_01</i>	Output current	Present output current
<i>E_02</i>	Output voltage	Present output voltage
<i>E_04</i>	Set frequency	Present set frequency
<i>E_05</i>	Rotational direction	This shows the rotational direction of a run command being output. F: forward; r: reverse; - - - -: stop
<i>E_06</i>	Running status	This shows the running status as a hexadecimal display. Refer to Displaying running status in Section 3.3.3 "Monitoring the running status."
<i>E_07</i>	Accumulated running time	Shows the cumulative power-ON time of the inverter. Unit: thousands of hours. When the total ON time is less than 10,000 hours (display: 0.001 to 9.999), it is possible to check data in hourly units. When the total time is 10,000 hours or more (display: 10.00 to 65.53), the display will change to units of 10 hours. When the total time exceeds 65,535 hours, the display returns to 0 and the count will start again.
<i>E_08</i>	No. of startups	The motor run times (the number of times the inverter run command is set to ON) are calculated and displayed. 1.000 indicates 1,000 times. When any number from 0.001 to 9.999 is displayed, the display increases by 0.001 per startup, and when any number from 10.00 to 65.53 is displayed, the display increases by 0.01 every 10 startups.
<i>E_09</i>	DC link bus voltage	Shows the DC link bus voltage of the inverter's main circuit. Unit: V (volts)
<i>E_11</i>	Max. temperature of heat sink	Shows the maximum temperature of the heat sink. Unit: °C
<i>E_12</i>	Terminal I/O signal status (displayed with the ON/OFF of LED segments)	Shows the ON/OFF status of the digital I/O terminals. Refer to Section 3.3.4 "[1] Displaying control I/O signal terminals" for details.
<i>E_13</i>	Terminal input signal status (in hexadecimal format)	
<i>E_14</i>	Terminal output signal status (in hexadecimal display)	
<i>E_15</i>	No. of consecutive occurrences	This is the number of times the same alarm has occurred consecutively.
<i>E_16</i>	Overlapping alarm 1	Simultaneously occurring alarm codes (1) (- - - - is displayed if no alarms have occurred.)
<i>E_17</i>	Overlapping alarm 2	Simultaneously occurring alarm codes (2) (- - - - is displayed if no alarms have occurred.)
<i>E_18</i>	Terminal I/O signal status under communication control (displayed with the ON/OFF of LED segments)	Shows the ON/OFF status of the digital I/O terminals under communication control. Refer to Section 3.3.4 "[2] Displaying control I/O signal terminals under communication control" for details.

Table 3.13 Continued

LED monitor shows: (Item No.)	Display contents	Description
E_19	Terminal input signal status under communication control (in hexadecimal format)	Shows the ON/OFF status of the digital I/O terminals under communication control. Refer to Section 3.3.4 "[2] Displaying control I/O signal terminals under communication control" for details.
E_20	Terminal output signal status under communication control (in hexadecimal display)	



When the same alarm occurs a number of times in succession, the alarm information for the first time is retained and the information for the following alarms is not updated.

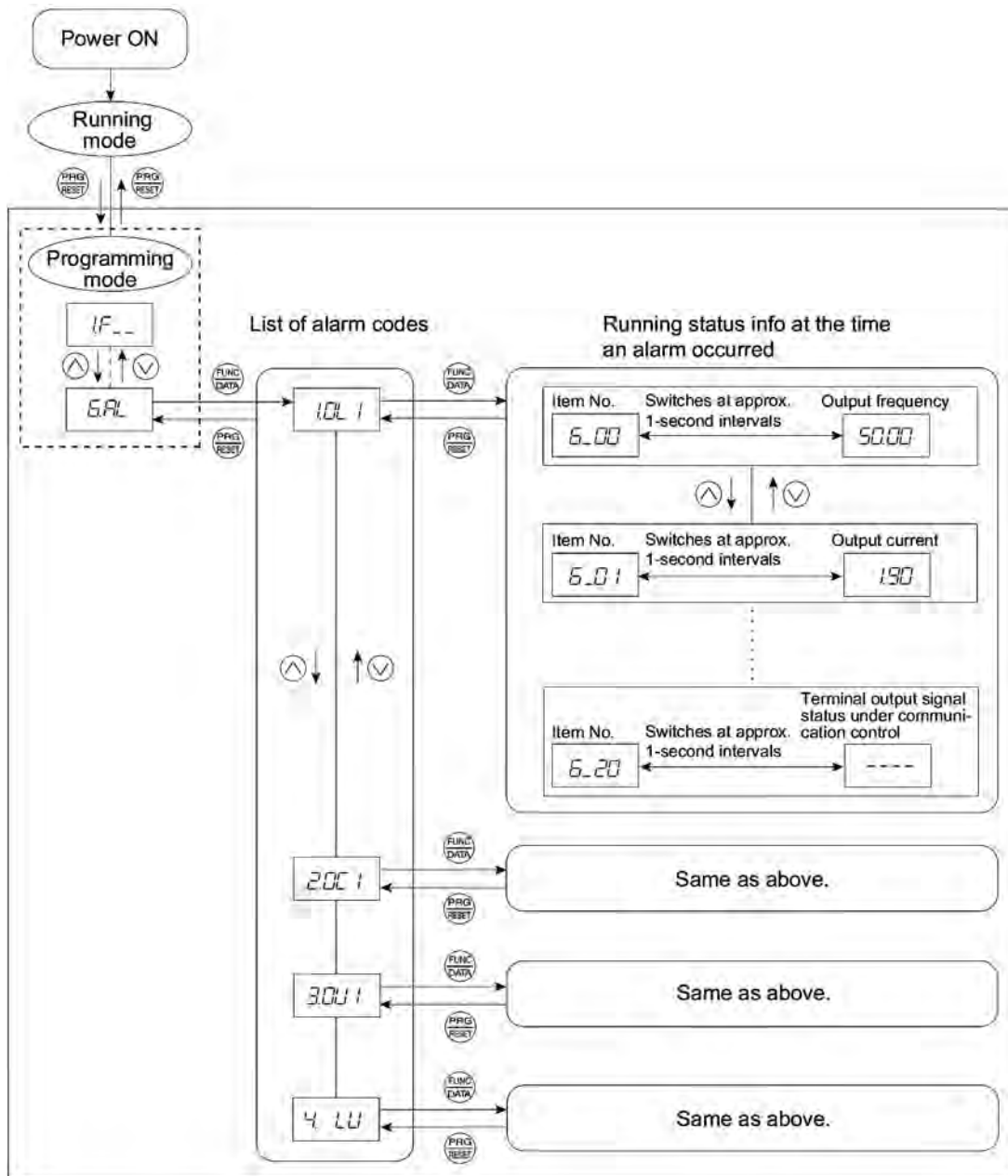

Figure 3.10 Status Transition of Alarm Information

Basic key operations

- (1) With the menu displayed, use \wedge/\vee keys to select "Alarm information" (E.AL).
- (2) Press the FUNC/DATA key to display the alarm list code (e.g. 1.OL 1).
In the list of alarm codes, the alarm information for the last 4 alarms will be saved as an alarm history.
- (3) Each time \wedge/\vee keys are pressed, the last four alarms are displayed in order from the most recent one as "1", "2", "3" and "4."
- (4) Press the FUNC/DATA key while the alarm code is displayed, and the corresponding alarm item number (e.g. 6.00) and data (e.g. Output frequency) will be displayed continuously in turn for 1 second each. It is possible to display the item number (e.g. 6.01) and data (e.g. Output current) for each desired alarm using \wedge/\vee keys.
- (5) Press the PRG/RESET key to return to the alarm list. Press the PRG/RESET key again to return to the menu.

Tip If the menu cannot switch to any other one, set function code E52 to 2 (Full-menu mode).

3.4 Alarm Mode

When the protective function is activated to issue an alarm, the inverter automatically transfers to Alarm mode and the alarm code will appear in the LED monitor. Figure 3.11 shows the status transition of Alarm mode.

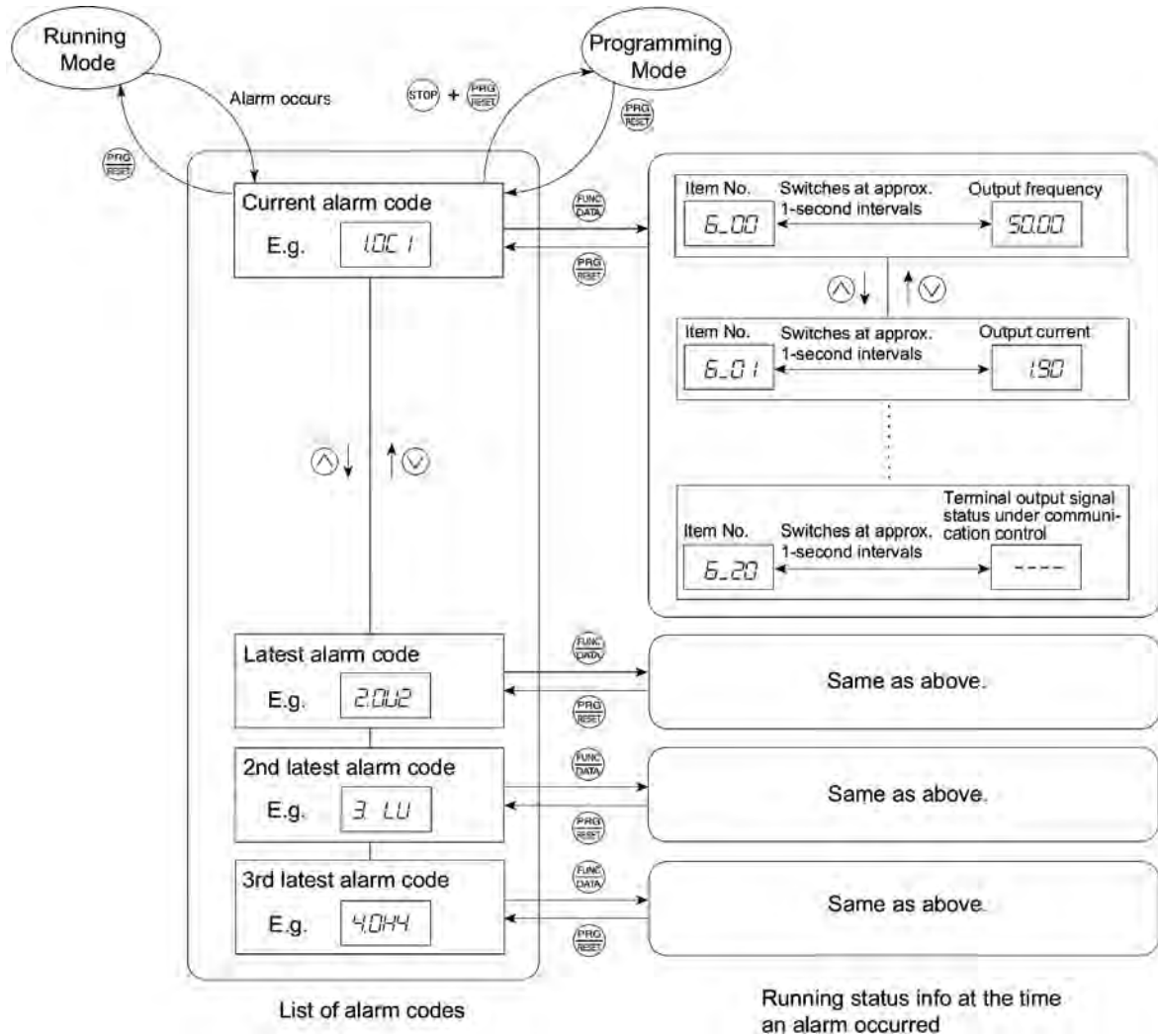

Figure 3.11 Status Transition of Alarm Mode

3.4.1 Releasing the alarm and transferring the inverter to Running mode



Remove the cause of the alarm and press the **PRG/RESET** key to release the alarm and return to Running mode. The **PRG/RESET** key is enabled only when the alarm code is displayed.

3.4.2 Displaying the alarm history



It is possible to display the most recent 3 alarm codes in addition to the one currently displayed. Previous alarm codes can be displayed by pressing \wedge / \vee keys while the current alarm code is displayed.

3.4.3 Displaying the running information when an alarm occurs



If an alarm occurs, you may check various running status information (output frequency and output current, etc.) by pressing the  key when the alarm code is displayed. The item number and data for each running information is displayed in alternation.

Further, you can switch between the various running information using  /  keys. Detailed running information is the same as for Menu #6 "Alarm information" in Programming mode. Refer to Table 3.13 in Section 3.3.6 "Reading alarm information."

Pressing the  key while the running information is displayed returns the display to the alarm codes.

 Pressing the  key continuously a number of times while the running information is displayed after removing the cause of the alarm will cause the inverter to transit to the alarm code display, and the next alarm to be released. If a run command had been input at this stage, the motor will start up.

3.4.4 Transferring to Programming mode

Further, it is also possible to transfer the inverter to Programming mode by pressing  +  keys simultaneously while the alarm is displayed and to then check and adjust the function code data.

Part 2 Driving the Motor



Chapter 4 BLOCK DIAGRAMS FOR CONTROL LOGIC

Chapter 5 RUNNING THROUGH RS-485 COMMUNICATION (OPTION)

Chapter 4

BLOCK DIAGRAMS FOR CONTROL LOGIC

This chapter describes the main block diagrams for the control logic of the FRENIC-Mini series of inverters.

Contents

4.1	Symbols Used in the Block Diagrams and their Meanings	4-1
4.2	Drive Frequency Command Generator	4-2
4.3	Drive Command Generator	4-4
4.4	Terminal Command Decoders.....	4-6
4.5	Digital Output Selector	4-10
4.6	Analog Output (FMA) Selector	4-12
4.7	Drive Command Controller.....	4-14
4.8	PID Frequency Command Generator.....	4-16

FRENIC-Mini inverters are equipped with a number of function codes to match a variety of motor operations required in your system. Refer to Chapter 9 "FUNCTION CODES" for details of the function codes.

The function codes have functional relationship with each other. Several special function codes also work with execution priority with each other depending upon their data settings.







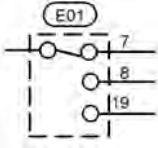
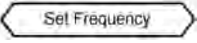
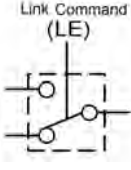

This chapter contains the main block diagrams for control logic in the inverter and describes the relationship between the inverter's logic and function codes. It is important to fully understand this relationship and to set the function code data correctly.

The block diagrams contained in the chapter show only function codes having mutual relation. For the function codes that work stand-alone and for details of individual function codes, refer to Chapter 9 "FUNCTION CODES."

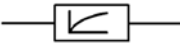
4.1 Symbols Used in the Block Diagrams and their Meanings

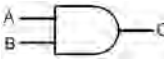
Table 4.1 lists the symbols commonly used in the block diagrams and their meanings with some examples.

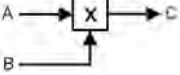
Table 4.1 Symbols and Meanings

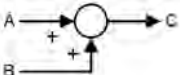
Symbol	Meaning	Symbol	Meaning
[FWD],[Y1] (etc.)	Input/output signals to/from the inverter's control terminal block.		Function code.
(FWD),(REV) (etc.)	Control commands assigned to the control terminal block input signals.		Switch controlled by a function code. Numbers assigned to the terminals express the function code data.
	Internal control command for inverter logic.		Switch controlled by an internal control command. In the example shown at the left, the link operation command (LE) is assigned to one of the digital input terminals from [X1] to [X3], which then controls the switch.
	High limiter: Limits peak value by a constant or by data set to the function code.		Low-pass filter: Features appropriate characteristics by changing the time constant through the function code data.
	Low limiter: Limits the bottom value by a constant or by data set to the function code.		AND logic: In normal logic systems, only if A = ON and B = ON, then C = ON. Otherwise, C = OFF.
	Zero limiter: Keeps data from dropping to a negative value.		OR logic: In normal logic systems, if any inputs are ON, then C = ON. Only if all inputs are OFF, then C = OFF.
	Gain multiplier for set frequencies given by current and/or voltage input or for analog output signals. $C = A \times B$		NOT logic: In normal logic systems, if A = ON, then B = OFF and vice versa.
	Adder for 2 signals or values. $C = A + B$ If B is negative then $C = A - B$.		

4.2 Drive Frequency Command Generator

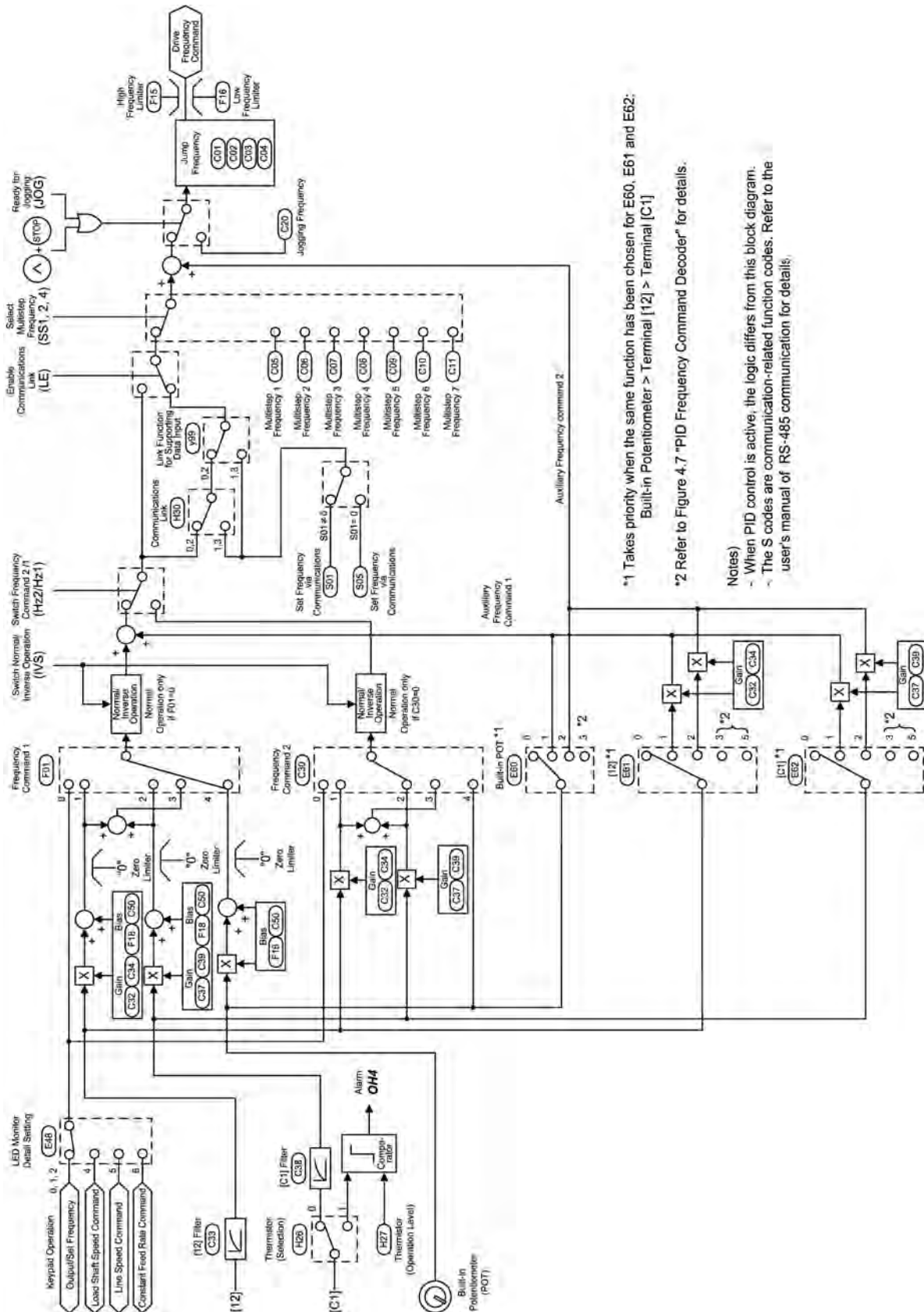

Figure 4.1 Block Diagram for Drive Frequency Command Generator

*1 Takes priority when the same function has been chosen for E60, E61 and E62:
Built-in Potentiometer > Terminal [12] > Terminal [C1]

*2 Refer to Figure 4.7 "PID Frequency Command Decoder" for details.

Notes

- When PID control is active, the logic differs from this block diagram.
- The S codes are communication-related function codes. Refer to the user's manual of RS-485 communication for details.

Figure 4.1 shows the processes that generate the final drive frequency command from the frequency settings given by various means and those switched/modified by function codes. If PID process control takes effect (J01=1 or 2), the drive frequency generation will differ from that shown in this diagram. (Refer to Section 4.8 "PID Frequency Command Generator.")

Additional and supplemental information is given below.

- Frequency settings using the \wedge / \vee key on the keypad may take a different format by means of the data setting for function code E48. Refer to function code E48 in Chapter 9 "FUNCTION CODES" for details.
- [C1] input as a frequency settings signal will always be interpreted as "0" when the current input signal terminal [C1] is specified for the thermistor (H26 = 1).
- Settings for both gain and bias will take effect concurrently only for frequency setting 1 (F01). For frequency setting 2 (C30) and auxiliary frequency settings 1 and 2 (E60 to E62), only the gain will take effect.
- Gain for the built-in potentiometer cannot be changed by any function code or other means.
- Switching between normal and inverse operation is only effective for frequency setting from the analog input signal (terminal [12], [C1] or built-in potentiometer). Frequency settings from the \wedge / \vee key are only valid for normal operation.
- The command formats for frequency settings by S01 and S05 for the communications link facility take a different form, as follows:
 - S01: the setting range is -32768 to $+32767$, where the maximum output frequency is obtained at ± 20000 .
 - S05: the setting range is 0.00 to 655.35 Hz in 0.01 Hz step, or 0.1 Hz step for over 600 Hz.
 - Priority level for setting for S01 is higher than that for S05. If a value other than 0 is set for S01, then the data set to S01 will take effect. If $S01 = 0$, then the setting for S05 will take effect.
 - Refer to the RS-485 Communication User's Manual for details.

4.3 Drive Command Generator

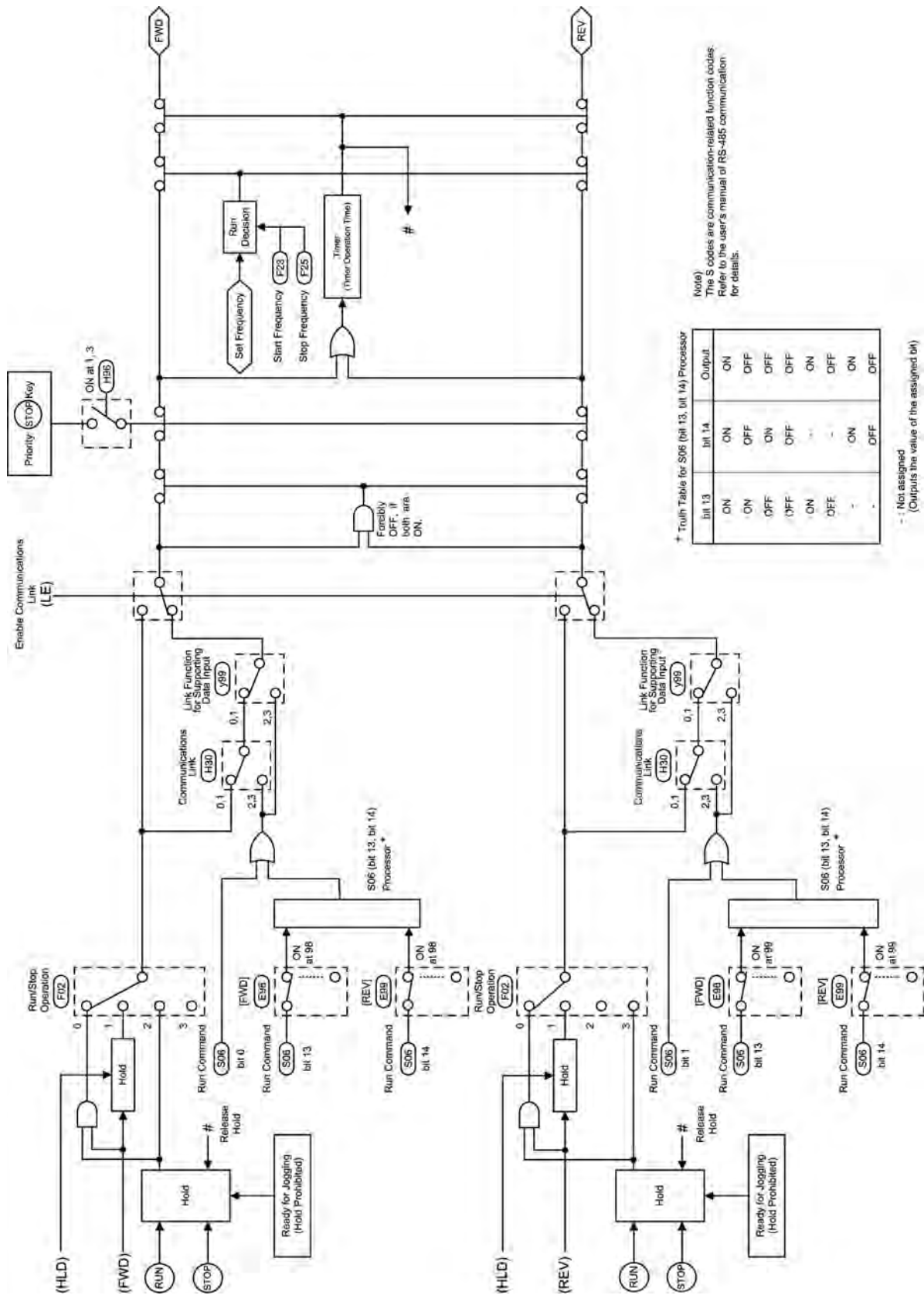

Note:
The S codes are communication-related function codes.
Refer to the user's manual of RS-485 communication
for details.

† Truth Table for S06 (bit 13, bit 14) Processor





bit 13	bit 14	Output
ON	ON	ON
ON	OFF	OFF
OFF	ON	OFF
OFF	OFF	OFF
ON	ON	ON
OFF	ON	OFF
ON	OFF	ON
OFF	OFF	OFF

- : Not assigned
(Outputs the value of the assigned bit)





Figure 4.2 Drive Command Generator

The drive command generator shown in Figure 4.2 produces final drive commands (FWD: Drive the motor in the forward direction) and (REV: Drive the motor in reverse direction) from the run commands that are given by various means and modified/switched by function codes.

Additional and supplemental information is given below.

- For the run command given by the  /  key, the generator holds the command ON upon depression of the  key and releases it upon depression of the  key except during jogging operation.
- The hold command (HLD) holds the run forward/reverse commands (FWD)/(REV) until it is turned OFF. This allows you to run the inverter in "3-Wire Operation." Refer to the function code E01 in Chapter 9 "FUNCTION CODES" for details.

If you do not assign a hold command (HLD) to any digital input terminals, then the "2-Wire Operation" using the (FWD) and (REV) command will be active.

- Setting 0 (zero) for function code F02 allows you to operate the inverter using the  /  key on the built-in keypad for the run command, while the (FWD) and (REV) commands determine direction of motor rotation. The logic shown in the block diagram shows you that if the run command from the  key and either the (FWD) or (REV) command are given, then the internal run command <FWD> or <REV> decoded internally by the logic turns ON.
- S06 (2-byte data for bit 15 through bit 0 can be manipulated), the operation command by the communications link, includes:
 - Bit 0: assigned to (FWD)
 - Bit 1: assigned to (REV)
 - Bits 13 and 14: programmable bits equivalent to the terminal inputs [FWD] and [REV]
 - In the block diagram, all of these are noted as operation commands. The data setting for function code E98 to specify the terminal signal property for [FWD] and E99 for [REV] determine which bit value should be selected as the run command. If bits 13 and 14 have the same setting to specify the property for (FWD) or (REV), the output of bit 13-14 processor logic will follow the truth table listed in Figure 4.2.
 - If either one of bits 13 and 14 is ON (1 as logic value), the OR logic will make the link command (LE) turn ON.
- If both run commands (FWD) and (REV) come ON concurrently, the logic forces the internal run commands <FWD> and <REV> to immediately turn OFF.
- If you set 1 or 3 to function code H96 (STOP key priority/Start Check) to make the  key priority effective, then depressing the  key forces the internal run commands <FWD> and <REV> to immediately turn OFF.
- If you have enabled operation via the timer, inputting any run command starts the timer. The internal run command <FWD> or <REV> and hold command (HLD) triggered by keypad will be automatically turned OFF after the time preset in the timer has elapsed.
- If the set frequency is lower than the start frequency (F23) or the stop frequency (F25), the internal run commands will remain OFF.

4.4 Terminal Command Decoders

Figures 4.3 (a) through (d) show five types of the terminal command decoder for the digital input signals.

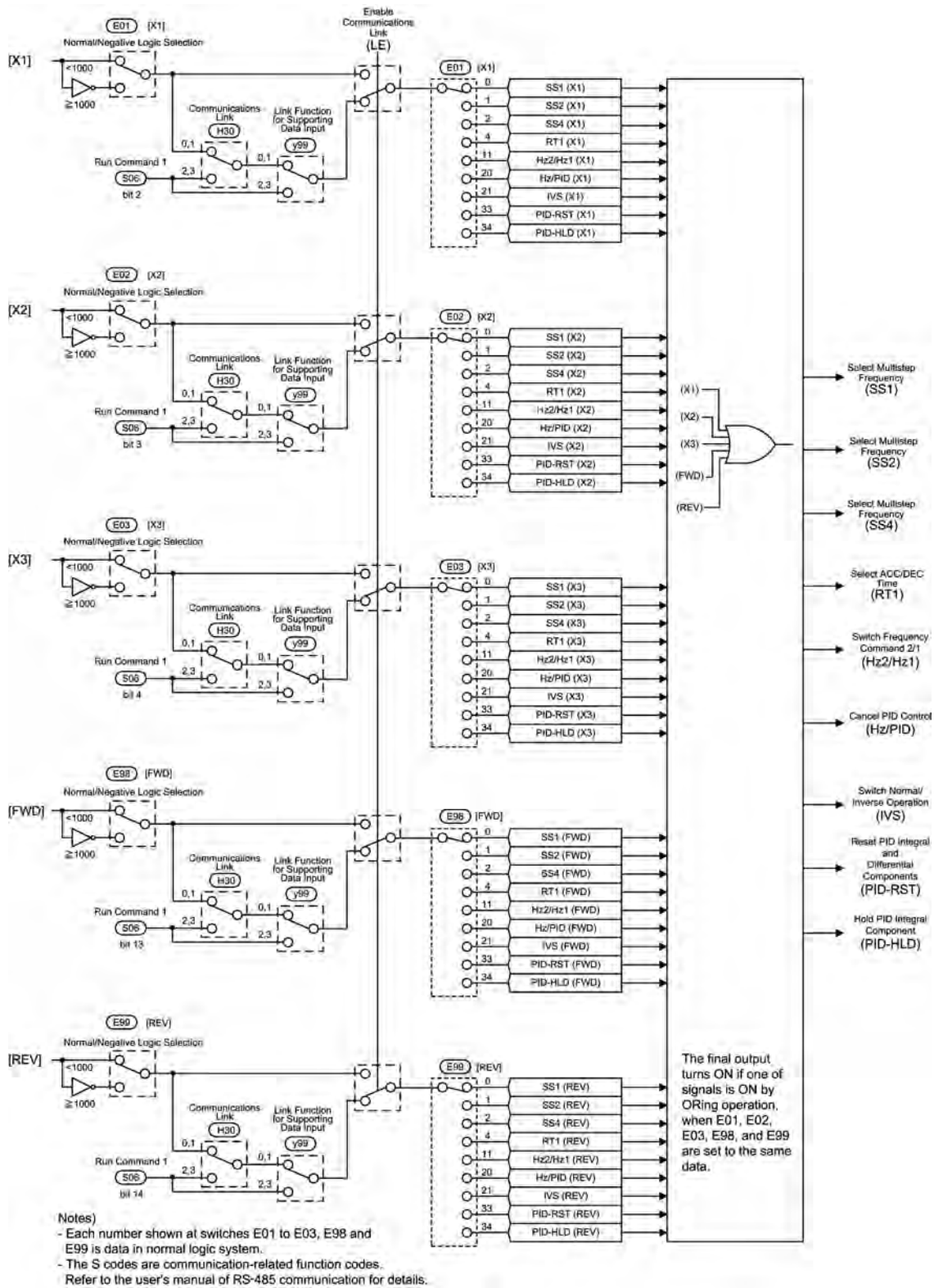

Figure 4.3 (a) Terminal Command Decoder (General)

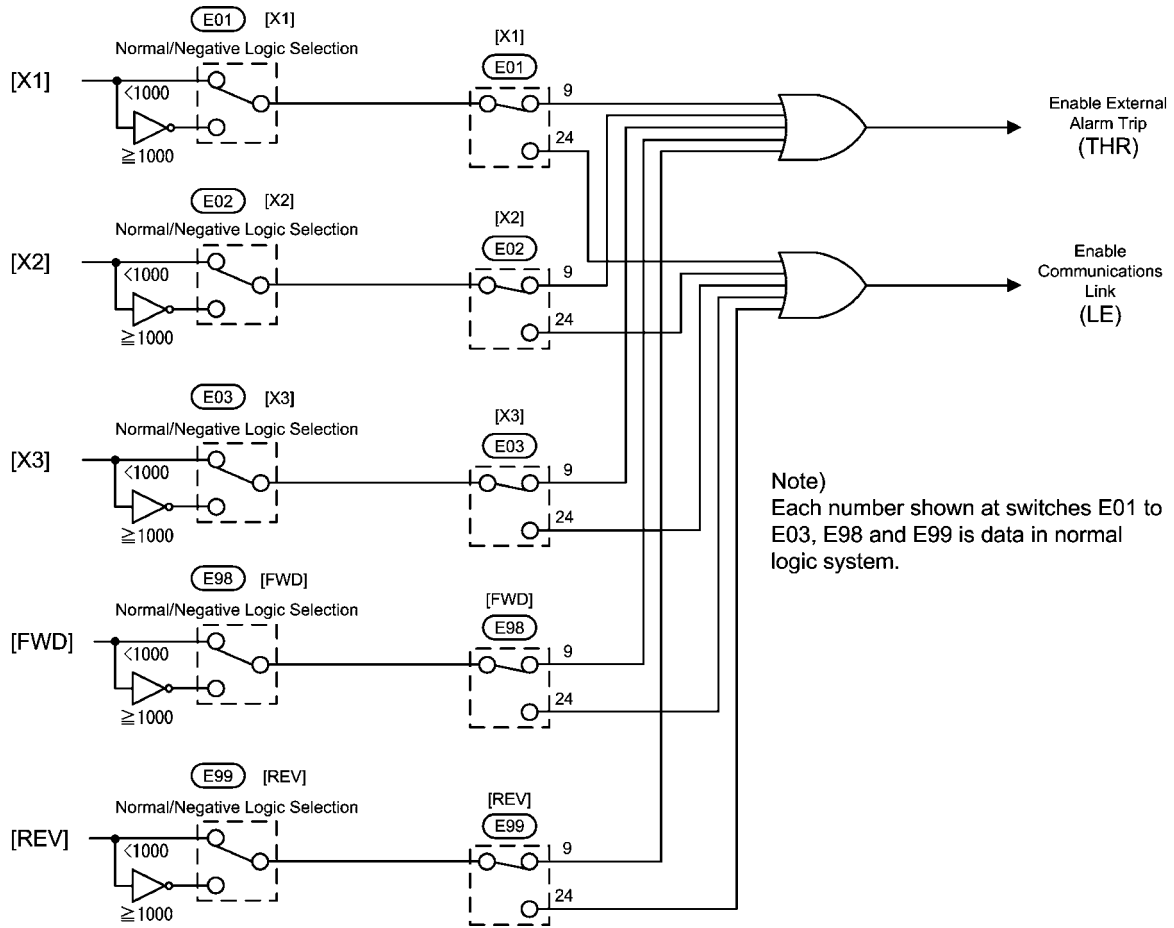

Figure 4.3 (b) Terminal Command Decoder (Terminal Signal Inputs)

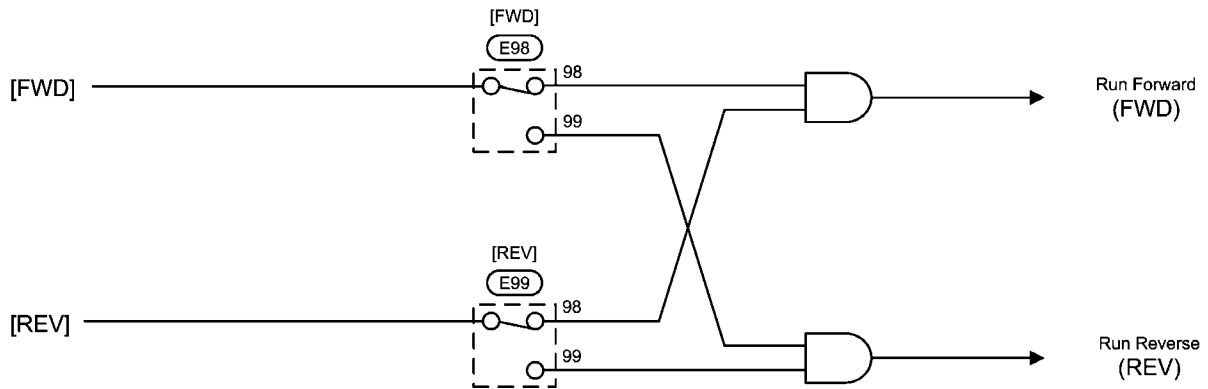

Figure 4.3 (c) Terminal Command Decoder (Terminal Signal Input Excluding Negative Logic)

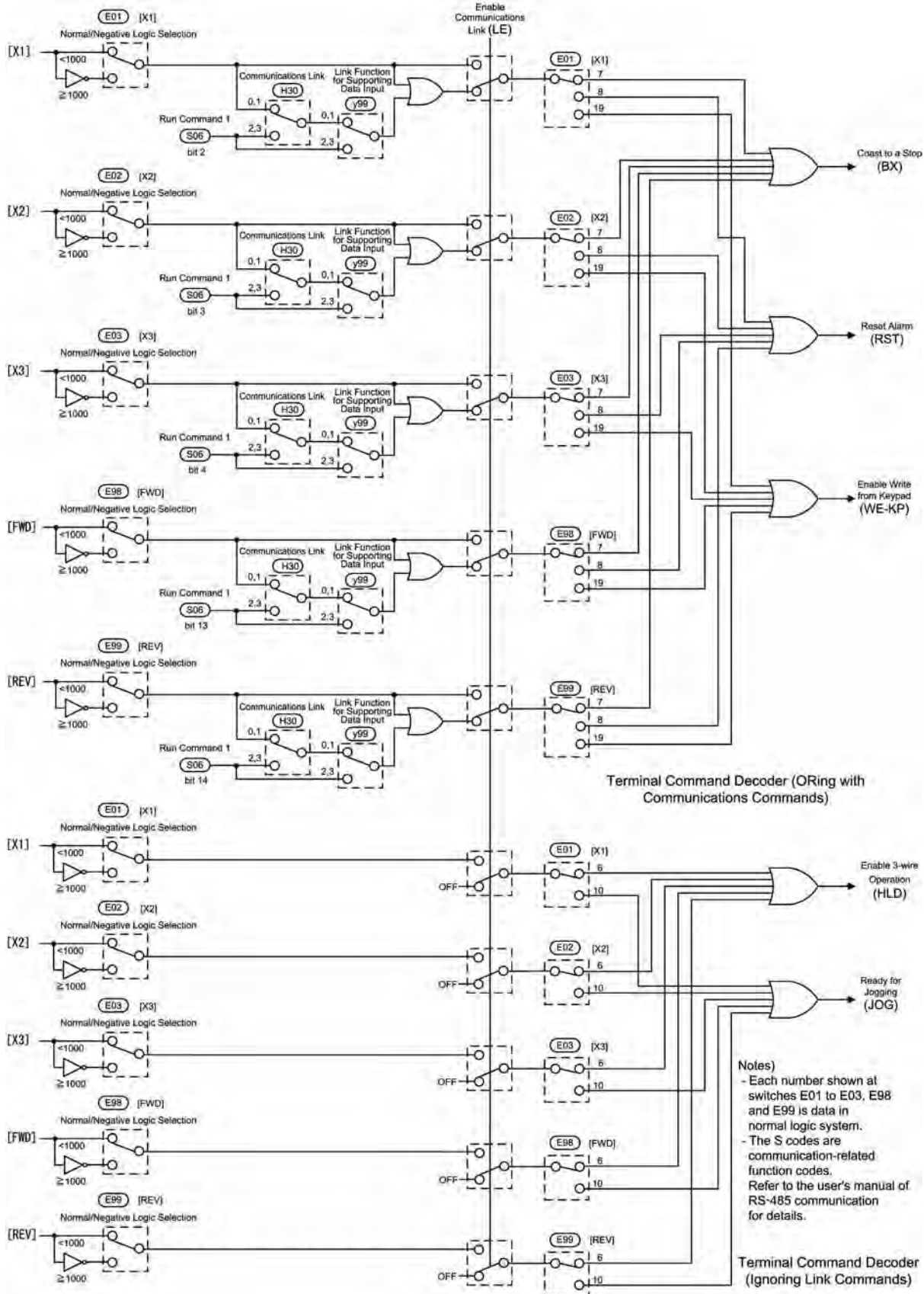

Figure 4.3 (d) Terminal Command Decoder (ORing with Link Commands/Ignoring Link Commands)

Programmable digital input terminals [X1], [X2], [X3], [FWD] and [REV] can be assigned to internal terminal commands such as (FWD) or (REV) decoded by data settings of related function codes as shown in the block diagrams in Figures 4.3 (a) through 4.3 (d). In the decoders, negative logic input signals are also applicable if you set data of 1000s to the function code.

The contents of the block diagram are divided into five groups, depending on whether inputs are assigned for the same internal terminal commands respectively or the commands issued from the communications facility (linked operation) specify the internal commands. Each of the diagrams shown in Figure 4.3 has following role.

- Figure 4.3 (a) The terminal command decoder (general) shows the decoding process of the internal commands functioning with the negative logic inputs. This is switchable with inputs from the communications facility (for example, link operation commands received through RS-485 communications).
- Figure 4.3 (b) The terminal command decoder (terminal signal inputs) shows the process to decode internal terminal commands dedicated to the control signal input applied to the inverter's terminal block. These commands cannot be changed via the communications facility (link operation command).
- Figure 4.3 (c) The terminal command decoder (terminal signal input excluding negative logic) shows process to produce (FWD) and (REV) commands. In this process, settings via the communications facility do not take effect. In the next process of the drive command generator, however, they may take effect. (Refer to the block diagram in Section 4.3, "Drive Command Generator.") To keep the inverter operation safe, any negative logic input for the (FWD) and (REV) commands cannot be applied.
- Figure 4.3 (d) The upper part of the terminal command decoder (ORing with link commands/ignoring link commands) shows the process to produce commands by ORing signals issued from the communications facility and the control signal input terminal block (Logical Oring. If any of input signals is ON, then the command becomes ON.).
- Figure 4.3 (d) The lower part of the terminal command decoder (ORing with link commands/ignoring link commands) shows the process to produce commands by forcing the inverter to ignore signals issued from the communications facility even if link operation ((LE): link operation command) has been turned ON.

4.5 Digital Output Selector

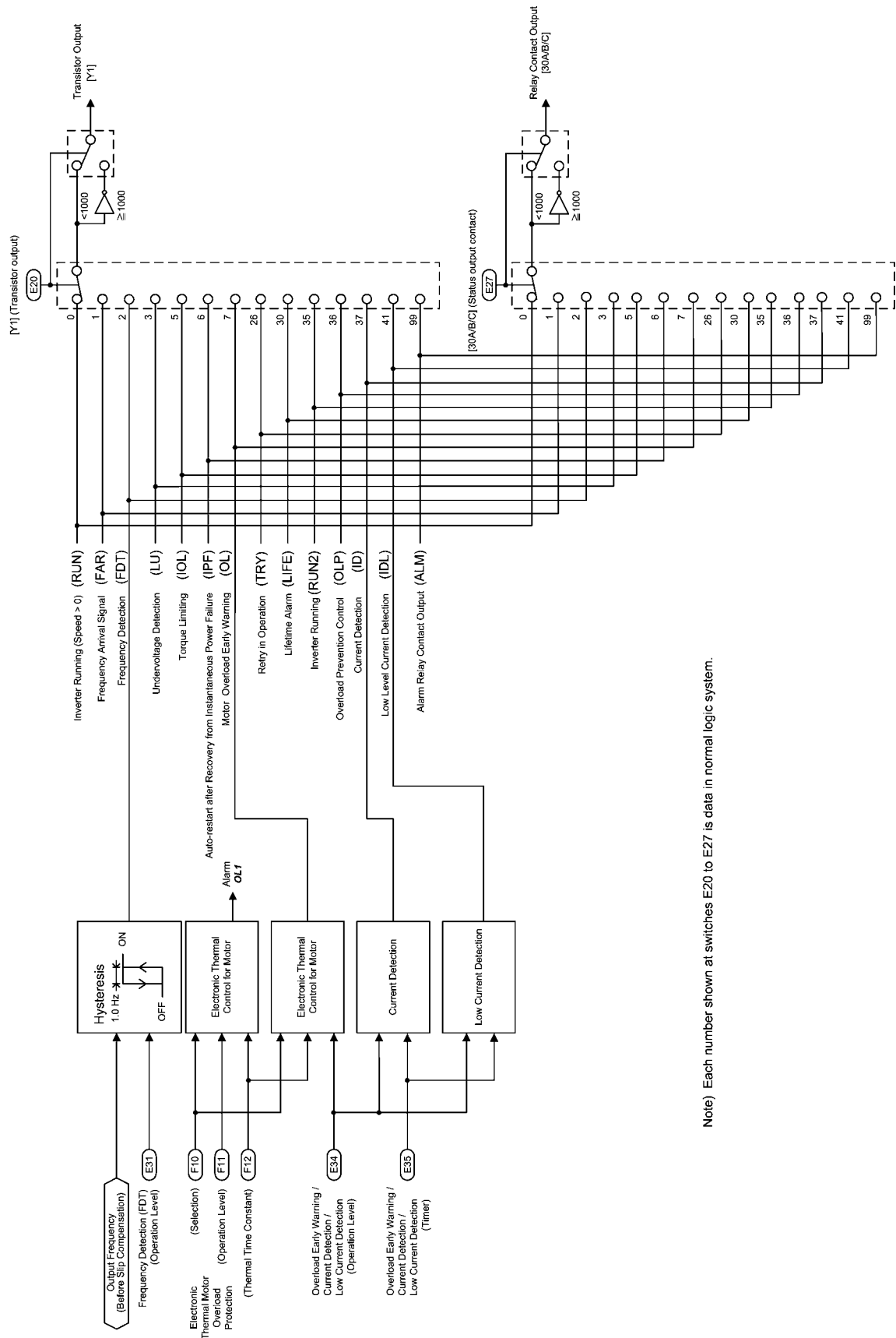

Note) Each number shown at switches E20 to E27 is data in normal logic system.

Figure 4.4 Digital Output Signal Selector

The block diagram shown in Figure 4.4 shows you the processes to select the internal logic signals for feeding to two digital output signals [Y1] and [30A/B/C]. The output terminals [Y1] (a transistor switch) and [30A/B/C] (mechanical relay contacts) are programmable. You can assign various functions to these terminals using function codes E20 and E27. Setting data of 1000s allows you to use these terminals for the negative logic system.

4.6 Analog Output (FMA) Selector

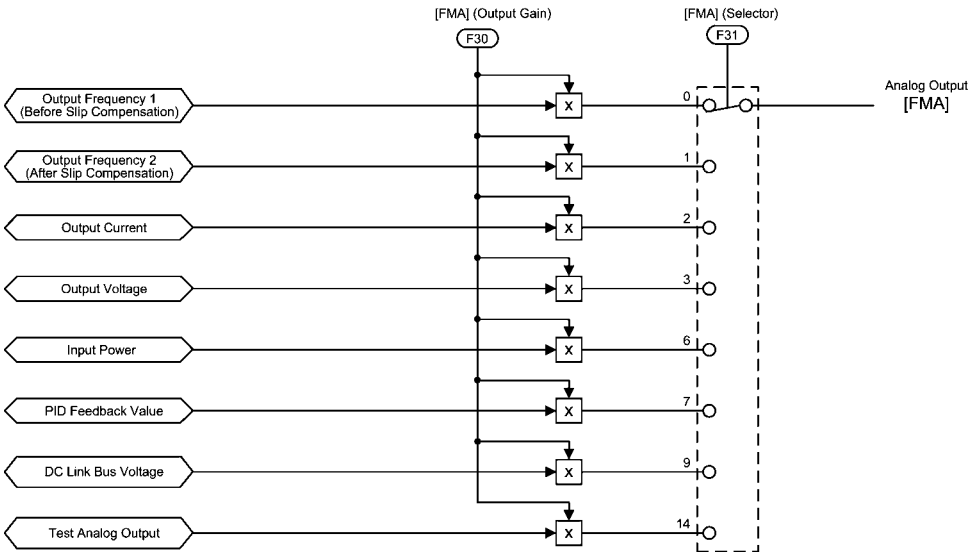

Figure 4.5 Analog Output (FMA) Selector

The block diagram shown in Figure 4.5 shows the process for selecting and processing the analog signals to be outputted to the analog output terminal [FMA]. Function code F31 determines the signals to be outputted to [FMA]. Function code F30 scales the output signal to a level suitable for the meters to be connected to the [FMA] terminal.

The output voltage range is 0 to 10 VDC and the maximum allowable load current is 2 mA. This is capable of driving two analog voltmeters with a common rating.

The test analog output is full-scale voltage output that adjusts the scale of the connected meter.

4.7 Drive Command Controller

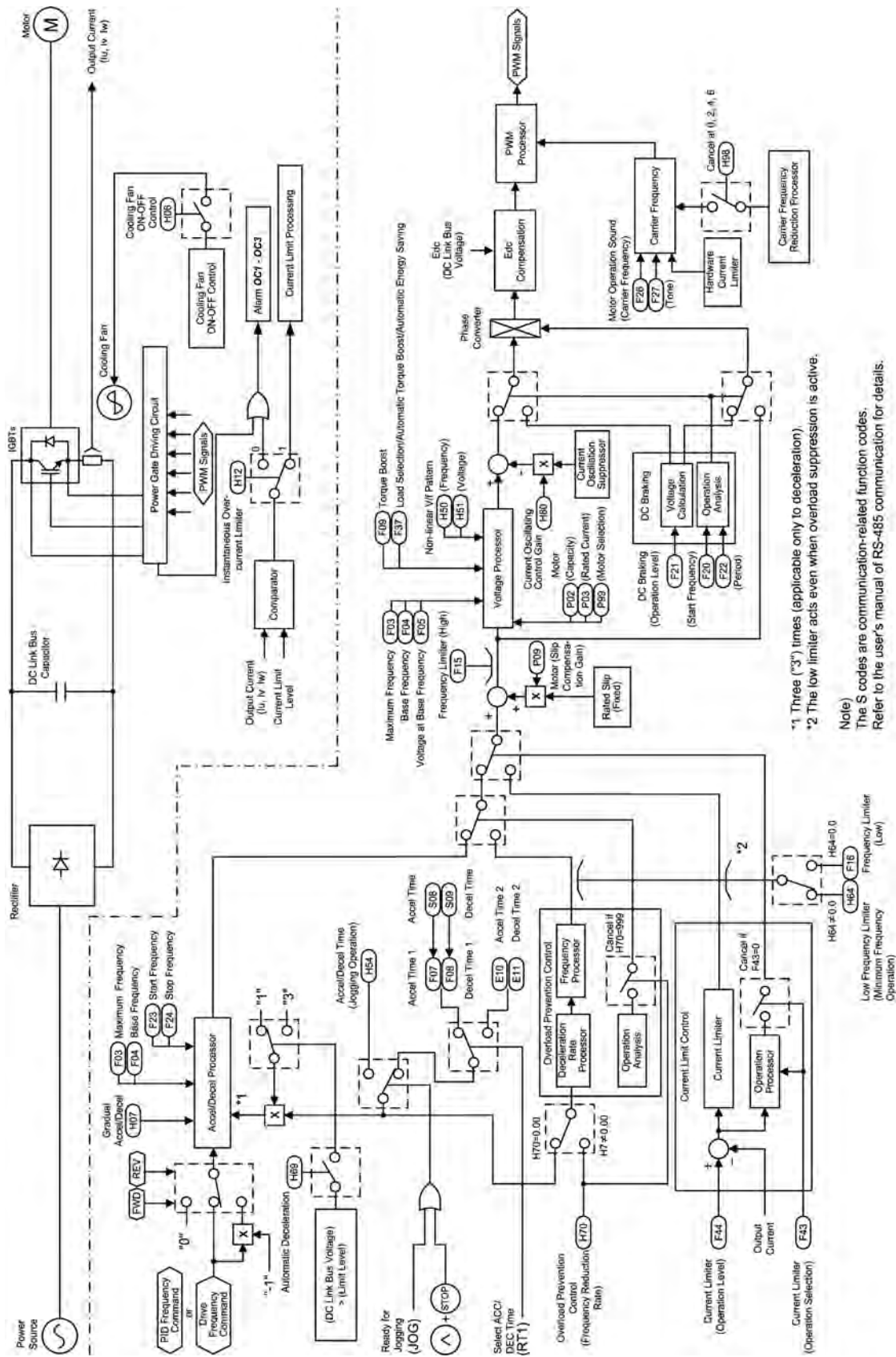

Figure 4.6 Drive Command Controller and Related Part of the Inverter

The simplified block diagram shown in Figure 4.6 explains the process in which the inverter drives the motor according to the internal run command <FWD>/<REV> from the frequency generator, or the PID frequency command from the PID controller, and the run commands.

Additional and supplemental information is given below.

- The logic shown in the left part of the block diagram processes the drive frequency command so as to invert ($\times(-1)$) the command for reverse rotation of the motor or to replace it with 0 (zero) for stopping the motor.
- The accelerator/decelerator processor determines the output frequency of the inverter by referring to the set data of related function codes. If the output frequency exceeds the peak frequency given by function code F15, the controller limits the output frequency at the peak.
- Acceleration/deceleration time is selectable from acceleration/deceleration time 1 or 2, or acceleration/deceleration time for jogging operation. The suppression of the regenerative braking feature may multiply the commanded acceleration/deceleration time by 3. Refer to role of function code H69 in the block diagram.
- If the overload prevention control feature is active, then the logic automatically switches the output frequency to one of overload suppression control and controls the inverter using the switched frequency. However, if the current limit control is active ($F43 \neq 30$, $H12 = 1$), the overload prevention control automatically becomes inactive.
- If the current limit control is active, then the logic automatically switches the output frequency to one of current limit control and controls inverter using the switched frequency.
- The slip compensation facility adds frequency components calculated from the load based on the preset rated slip frequency inside the inverter to the frequency currently commanded. The logic adjusts the error between the rated slip frequency of the motor currently under load and the preset frequency according to the set data of function code P09 that controls slip compensation gain for the motor.
- The voltage processor determines the output voltage of the inverter. The processor adjusts the output voltage to control the motor output torque.
- If DC braking control is active, the logic switches the voltage and frequency control components to ones determined by the DC braking block to feed the proper power to the motor for DC braking.

4.8 PID Frequency Command Generator

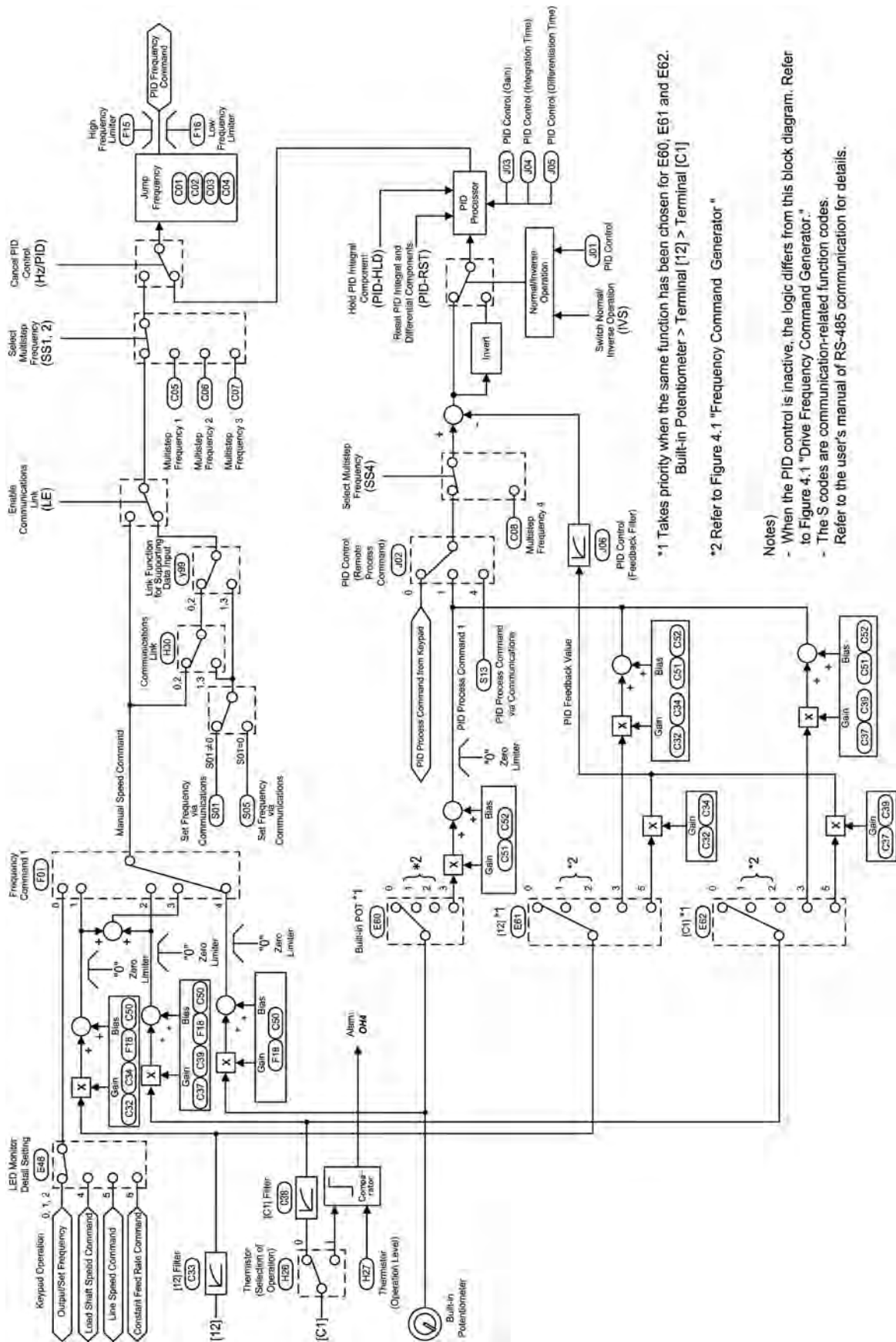

Figure 4.7 PID Frequency Command Generator

*1 Takes priority when the same function has been chosen for E60, E61 and E62.
Built-in Potentiometer > Terminal [12] > Terminal [C1]

*2 Refer to Figure 4.1 "Frequency Command Generator"

Notes)

- When the PID control is inactive, the logic differs from this block diagram. Refer to Figure 4.1 "Drive Frequency Command Generator."
- The S codes are communication-related function codes. Refer to the user's manual of RS-485 communication for details.

The block diagram shown in Figure 4.7 shows the PID frequency command generator that becomes active when the PID control is enabled ($J01 = 1$ or 2). The logic shown generates the final frequency command according to the PID process command given by various means of setting and feedback, or frequency settings as a speed command given manually, and various means of switching.

Additional and supplemental information is given below.

- Switching of data settings for frequency 2 (C30), auxiliary frequencies 1 and 2 (E60 to E62) as manual speed commands will be disabled.
- For multistep frequency settings, settings 1 to 3 are exclusively applicable to the manual PID speed command.
- For selecting analog input (terminal [12], [C1], or built-in POT) as the PID process command, you need to set proper data for function codes E60 to E62 and J02.
- For the multistep frequency, setting data 4 (C08) is exclusively applicable to PID process command.
- To switch the operation between normal and inverse, the logic inverses polarity of deviation between the PID command and its feedback (turning (INV) command ON/OFF, or setting $J01 = 1$ or 2).
- Refer to Section 4.2 " Drive Frequency Command Generator" for explanations of common items.

Chapter 5

RUNNING THROUGH RS-485 COMMUNICATION (OPTION)

This chapter describes an overview of inverter operation through the RS-485 communications facility. Refer to the RS-485 Communication User's Manual for details.

Contents

5.1	Overview on RS-485 Communication	5-1
5.1.1	Common specifications	5-2
5.1.2	Connector specifications	5-3
5.1.3	Connection	5-3

5.1 Overview on RS-485 Communication

Mounting an optional RS-485 communications card on the FRENIC-Mini series of inverters enables the following:

■ Operation from a remote keypad

A remote keypad can be connected to the RS-485 communications card using the extension cable. You may install the remote keypad to the easy-to-access front of the control panel. The maximum length of the extension cable is 66 ft (20 m).

■ Operation by FRENIC Loader

The Windows-based PC can be connected to the RS-485 communications card. Through the RS-485 communications facility, you may run FRENIC Loader in the PC to edit the function code data and monitor the running status information of the inverter.

■ Operation from the host equipment

Host equipment such as a PLC or personal computer can be connected to the RS-485 communications card. It may act as a master device that controls the inverter as a slave device.

Protocols for managing a network including inverters include the Modbus RTU protocol (compliant to the protocol established by Modicon Inc.) that is widely used in FA markets and the Fuji general-purpose protocol that supports the FRENIC-Mini and conventional series of inverters.



For the remote keypad, the inverter uses the dedicated protocol that automatically switches the operation source to the remote keypad, so no function code setting is required.

For FRENIC loader, however, you need to set up function code H30 for some communications conditions although the dedicated protocol is used.

5.1.1 Common specifications

Items	Specifications		
	FGI-BUS	Modbus RTU	FRENIC Loader
Protocol	FGI-BUS	Modbus RTU	FRENIC Loader
Compliance	Fuji general-purpose inverter protocol	Modicon Modbus RTU-compliant (only in RTU mode)	Dedicated protocol (Not disclosed)
No. of supporting stations	Host device: 1 Inverters: up to 31		
Electrical specifications	EIA RS-485		
Connection to RS-485	8-wire RJ-45 connector		
Synchronization	Start-Stop system		
Transmission mode	Half-duplex		
Transmission speed	2400, 4800, 9600 or 19200 bps		
Max. transmission cable length	1,640 ft (500 m)		
No. of available station addresses	1 to 31	1 to 247	1 to 255
Message frame format	FGI-BUS	Modbus RTU	FRENIC loader
Frame synchronization	Detection SOH (Start Of Header) character	Detection of no-data transmission time for 3-byte period	Start code 96H detection
Frame length	16 bytes (fixed) in normal transmission 8 or 12 bytes in high-speed transmission	Variable length	Variable length
Max. transfer data	Write: 1 word Read: 1 word	Write: 50 words Read: 50 words	Write: 41 words Read: 41 words
Messaging system	Polling/Selecting/Broadcast		Command message
Transmission character format	ASCII	Binary	Binary
Character length	8 or 7 bits (selectable by the function code)	8 bits (fixed)	8 bits (fixed)
Parity	Even, Odd, or None (selectable by the function code)		Even
Stop bit length	1 or 2 bits (selectable by the function code)	No parity: 2 bits Even or Odd parity: 1 bit	1 bit (fixed)
Error checking	Sum-check	CRC-16	Sum-check

5.1.2 Connector specifications

The RS-485 communications card is equipped with an RJ-45 connector whose pin assignment is listed in the table below.

Pin	Signal name	Function	Remarks
1 and 8	Vcc	Power source for the remote keypad	5V
2 and 7	GND	Reference voltage level	GND
3 and 6	NC	Not used.	
4	DX-	RS-485 data (-)	Built-in terminator: 112 Ω
5	DX+	RS-485 data (+)	Open/close by SW1

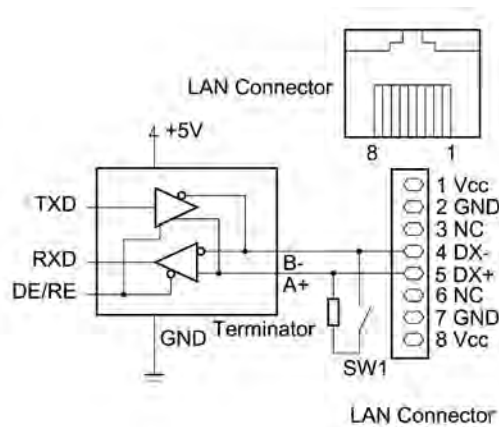

Note The RJ-45 connector has power source pins (pins 1 and 8) designed for the remote keypad. When connecting other devices to the RJ-45 connector, take care not to use those pins. Failure to do so may cause a short-circuit.

5.1.3 Connection

You need to select devices suitable for your network configuration, referring to the figure shown below.

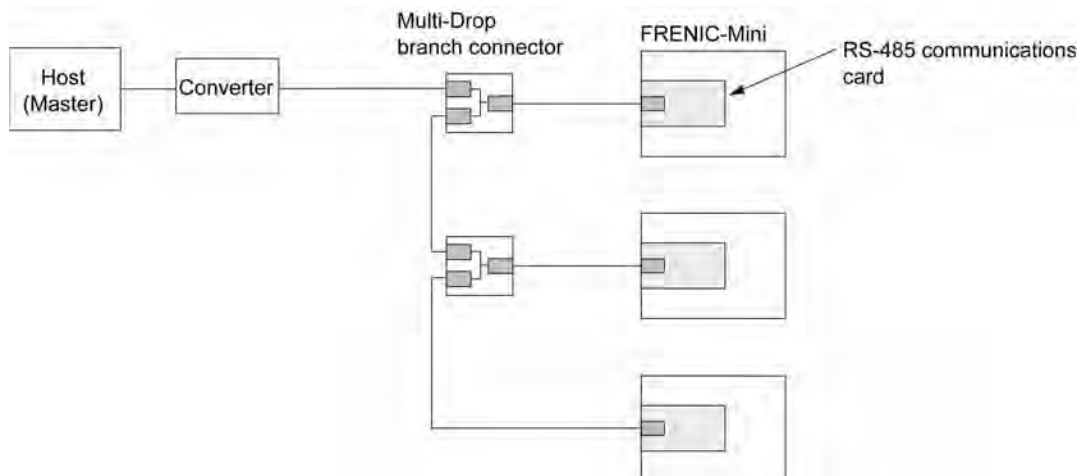

Converter

Equipment such as personal computers is not equipped with an RS-485 communications port but with an RS-232C port, so an RS-485/RS-232C converter is required to connect them to the RS-485 communications card. It is recommended that insulated converters such as RS-485/RS-485 converters (KS-485PTI by System Sacomm, Inc.) be used for eliminating electric noise.

Multi-drop branch connector

The RS-485 communications port of the communications card uses an RJ-45 connector. For multi-drop connection of inverters, multi-drop branch connectors (MS8-BA-JJJ by SK Koki Co.) are required.

Cable

For the connection of the remote keypad, use an 8-wire straight cable with an RJ-45 connector. (Remote keypad extension cable option: CB-5S)

For the connection of other equipment or connection of FRENIC-Mini inverters with each other, use a cable that has signal wires only. (EIA568-compliant 10BASE-T)



- No converter is required for connection of the remote keypad.
- To connect the FVR-E11S series of general-purpose inverters to the FRENIC-Mini series, take necessary measures for the difference of the pin assignment between FVR-E11S and FRENIC-Mini series to avoid a short-circuited failure.

Part 3 Peripheral Equipment and Options



Chapter 6 SELECTING PERIPHERAL EQUIPMENT

Chapter 6

SELECTING PERIPHERAL EQUIPMENT

This chapter describes how to use a range of peripheral equipment and options, FRENIC-Mini's configuration with them, and requirements and precautions for selecting wires and crimp terminals.

Contents

6.1	Configuring the FRENIC-Mini	6-1
6.2	Selecting Wires and Crimp Terminals.....	6-2
6.2.1	Recommended wires	6-4
6.2.2	Crimp terminals.....	6-6
6.3	Peripheral Equipment.....	6-7
[1]	Molded case circuit breaker (MCCB), ground fault circuit interrupter (GFCI) and magnetic contactor (MC).....	6-7
[2]	Surge killers.....	6-11
[3]	Arresters	6-11
[4]	Surge absorbers	6-12
6.4	Selecting Options	6-13
6.4.1	Peripheral equipment options.....	6-13
[1]	Braking resistors.....	6-13
[2]	DC reactors (DCRs)	6-16
[3]	AC reactors (ACRs)	6-18
[4]	Output circuit filters (OFLs).....	6-19
[5]	Ferrite ring reactors for reducing radio noise (ACL).....	6-20
6.4.2	Options for operation and communications	6-21
[1]	External potentiometer for frequency setting	6-21
[2]	RS-485 communications card "OPC-C1-RS".....	6-22
[3]	Remote keypad "TP-E1"	6-22
[4]	Extension cable for remote operation.....	6-23
[5]	Copy adapter "CPAD-C1A"	6-23
[6]	Inverter support loader software.....	6-23
6.4.3	Extended installation kit options	6-24
[1]	Mounting adapters	6-24
[2]	Rail mounting bases	6-25
[3]	NEMA1 kit.....	6-26
6.4.4	Meter options	6-27
[1]	Frequency meters.....	6-27

6.1 Configuring the FRENIC-Mini

This section lists the names and features of peripheral equipment and options for the FRENIC-Mini series of inverters and includes a configuration example for reference. Refer to Figure 6.1 for a quick overview of available options.

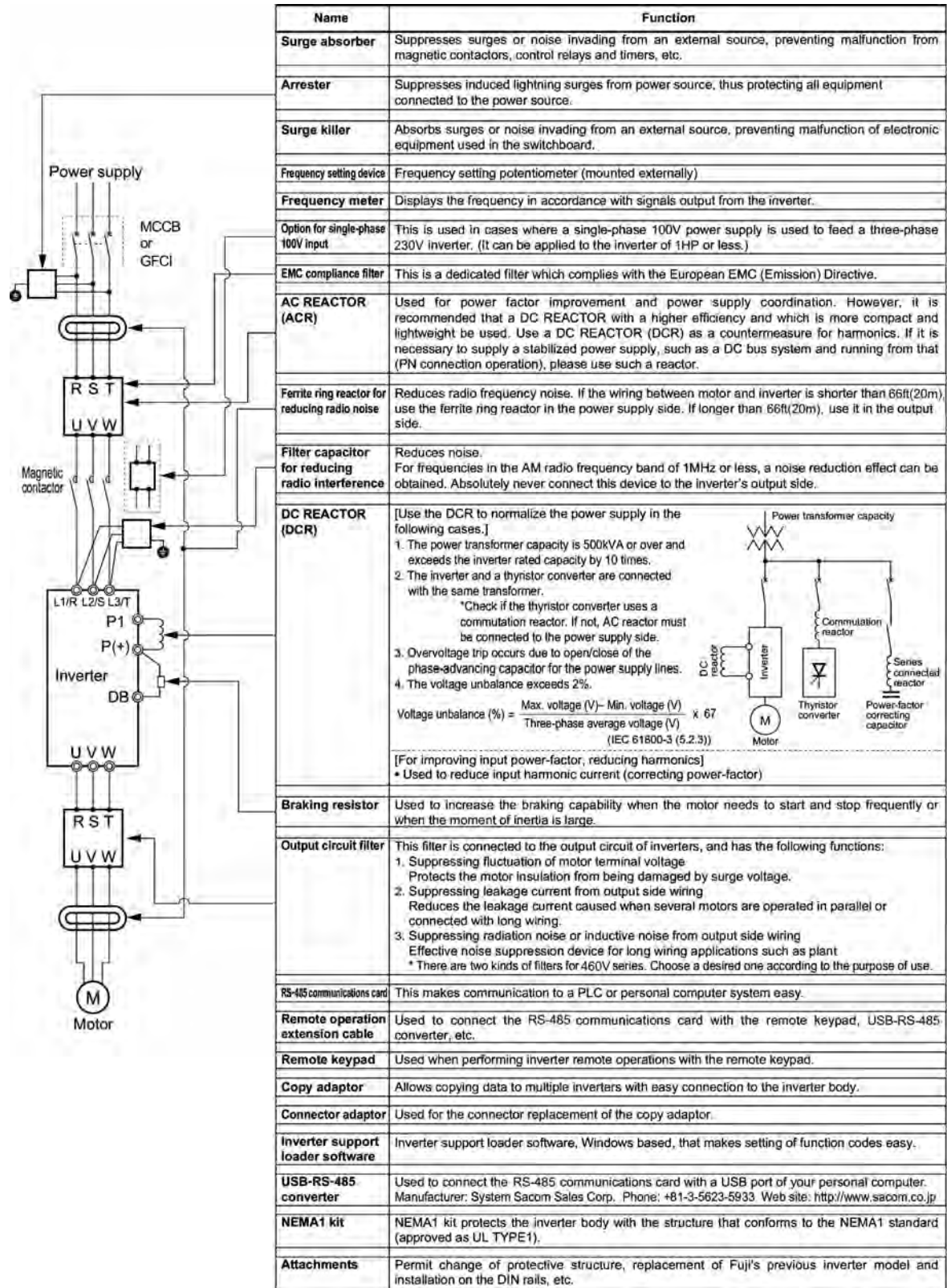

Figure 6.1 Quick Overview of Options

6.2 Selecting Wires and Crimp Terminals

This section contains information needed to select wires for connecting the inverter to commercial power lines, motor or any of the optional/peripheral equipment. The level of electric noise issued from the inverter or received by the inverter from external sources may vary depending upon wiring and routing. To solve such noise-related problems, refer to Appendix A "Advantageous Use of Inverters (Notes on electrical noise)."

Select wires that satisfy the following requirements:

- Sufficient capacity to flow the rated average current (allowable current capacity).
- Protective device coordination with an overcurrent circuit breaker such as an MCCB in the overcurrent zone for overcurrent protection.
- Voltage loss due to the wire length is within the allowable range.
- Suitable for the type and size of terminals of the optional equipment to be used.

Recommended wires are listed below. Use these wires unless otherwise specified.

■ 600V class of vinyl-insulated wires (IV wires)

Use this class of wire for the power circuits. This class of wire is hard to twist, so using it for the control signal circuits is not recommended. Maximum ambient temperature for this wire is 60°C (140°F).

■ 600V heat-resistant PVC insulated wires or 600V polyethylene insulated wires (HIV wires)

As wires in this class are smaller in diameter and more flexible than IV wires and can be used at a higher ambient temperature 75°C (167°F), they can be used for both of the main power and control signal circuits. To use this class of wire for the control circuits, you need to correctly twist the wires and keep the wiring length for equipment being connected as short as possible.

■ 600V cross-linked polyethylene-insulated wires (FSLC wires)

Use this class of wire mainly for power and grounding circuits. These wires are smaller in diameter and more flexible than those of the IV and HIV classes of wires, meaning that these wires can be used to save on space and increase operation efficiency of your power system, even in high temperature environments. The maximum allowable ambient temperature for this class of wires is 90°C (194°F). The (Boardlex) wire range available from Furukawa Electric Co., Ltd. satisfies these requirements.

■ Shielded-Twisted cables for internal wiring of electronic/electric equipment

Use this category of cables for the control circuits of the inverter so as to prevent the signal lines from being affected by noise from external sources, including the power input/output lines of the inverter themselves. Even if the signal lines are inside the power control cabinet, always use this category of cables when the length of wiring is longer than normal. Cables satisfying these requirements are the Furukawa's BEAMEX S shielded cables of the XEBV and XEWV ranges.

Currents Flowing across the Inverter Terminals

Table 6.1 summarizes average (effective) electric currents flowing across the terminals of each inverter model for ease of reference when selecting peripheral equipment, options and electric wires for each inverter--including supplied power voltage and applicable motor rating.

Table 6.1 Currents Flowing through Inverter

Power supply voltage	Applicable motor rating (HP)	230 V/460 V (380 V), 50 Hz				230 V (200 V)/460 V (380 V), 60 Hz			
		Input RMS current (A)		DC link bus current (A)	Braking resistor circuit current (A)	Input RMS current (A)		DC link bus current (A)	Braking resistor circuit current (A)
		DC reactor (DCR)				DC reactor (DCR)			
		w/ DCR	w/o DCR	w/ DCR	w/o DCR				
Three-phase 230 V	1/8	0.57	1.1	0.70	-	0.51 (0.55)	1.1 (1.1)	0.62 (0.67)	-
	1/4	0.93	1.7	1.1	-	0.85 (0.92)	1.7 (1.8)	1.0 (1.1)	-
	1/2	1.6	3.0	2.0	1.2	1.5 (1.6)	3.0 (3.0)	1.8 (2.0)	1.2
	1	3.0	5.1	3.7	1.6	2.8 (3.0)	5.0 (5.3)	3.4 (3.7)	1.6
	2	5.7	9.4	7.0	3.6	5.2 (5.6)	9.0 (9.5)	6.3 (6.9)	3.6
	3	8.3	13.0	10.2	3.5	7.6 (8.3)	12.3 (13.2)	9.3 (10.1)	3.5
Three-phase 460 V	5	14.0	22.2	17.2	4.1	12.7 (13.9)	20.6 (22.2)	15.6 (17.0)	4.1
	1/2	0.81 (0.85)	1.6 (1.7)	0.99 (1.0)	0.8	0.74 (0.85)	1.7 (1.7)	0.91 (1.0)	0.8
	1	1.5 (1.6)	2.9 (3.0)	1.8 (1.9)	1.1	1.4 (1.6)	3.0 (3.0)	1.7 (2.0)	1.1
	2	2.9 (3.0)	5.7 (5.7)	3.5 (3.6)	1.8	2.6 (3.0)	5.1 (5.9)	3.2 (3.6)	1.8
	3	4.2 (4.4)	7.9 (7.9)	5.1 (5.3)	1.8	3.8 (4.3)	7.1 (8.2)	4.6 (5.3)	1.8
Single-phase 230 V	5	7.0 (7.3)	12.5 (13.0)	8.6 (9.0)	2.1	6.4 (7.3)	11.1 (12.9)	7.8 (8.9)	2.1
	1/8	1.1	1.8	1.1	-	1.0 (1.1)	1.8 (1.8)	1.0 (1.1)	-
	1/4	2.0	3.2	2.0	-	1.8 (1.9)	3.1 (3.2)	1.8 (1.9)	-
	1/2	3.5	5.2	3.5	0.82	3.1 (3.4)	5.0 (5.4)	3.1 (3.4)	0.82
	1	6.4	9.5	6.4	1.4	5.8 (6.3)	9.1 (9.7)	5.8 (6.3)	1.4
	2	11.7	16.0	11.7	1.4	10.5 (11.3)	15.5 (16.4)	10.5 (11.3)	1.4
3	17.5	24.2	17.5	1.7	15.8 (17.0)	23.4 (24.8)	15.8 (17.0)	1.7	

- Inverter efficiency is calculated using values suitable for each inverter model. The input route mean square (RMS) current is calculated according to the following conditions:
Power source capacity: 500 kVA; power source internal impedance: 5%
- The current listed in the above table will vary in inverse proportion to the power supply voltage, such as 230 VAC and 380 VAC.
- The braking current is always constant, independent of braking resistor specifications, including built-in, standard and 10%ED models.

6.2.1 Recommended wires

Tables 6.2 and 6.3 list the recommended wires according to the internal temperature of your power control cabinet.

■ If the internal temperature of your power control cabinet is 50°C (122°F) or below

Table 6.2 Wire Size (for main circuit power input and inverter output)

Power supply voltage	Applicable motor rating (HP)	Inverter type	Recommended wire size [inch ² (mm ²)]													
			Main circuit power input [L1/R, L2/S, L3/T] or [L1/L, L2/N]						Inverter output [U, V, W]							
			w/ DC reactor (DCR)			w/o DC reactor (DCR)			w/ DC reactor (DCR)			w/o DC reactor (DCR)				
			Allowable temp.*1			Current	Allowable temp.*1			Current	Allowable temp.*1			Current		
60°C (140°F)	75°C (167°F)	90°C (194°F)	(A)	60°C (140°F)	75°C (167°F)	90°C (194°F)	(A)	60°C (140°F)	75°C (167°F)	90°C (194°F)	(A)					
Three-phase 230 V	1/8	FRNF12C1 ■-2U				0.57						1.1			0.8	
	1/4	FRNF25C1 ■-2U				0.93						1.8			1.5	
	1/2	FRNF50C1 ■-2U				1.6	0.003					3.1	0.003		3.0	
	1	FRN001C1 ■-2U	0.003	0.003	0.003	3.0	(2.0)	0.003	0.003			5.3	(2.0)	0.003	0.003	5.5
	2	FRN002C1 ■-2U	(2.0)	(2.0)	(2.0)	5.7						9.5		(2.0)	(2.0)	8.0
	3	FRN003C1 ■-2U				8.3						13.2				11
Three-phase 460 V	1/2	FRNF50C1 ■-4U				0.85						1.7			1.5	
	1	FRN001C1 ■-4U	0.003	0.003	0.003	1.6	0.003	0.003	0.003			3.1	0.003	0.003	2.5	
	2	FRN002C1 ■-4U	(2.0)	(2.0)	(2.0)	3.0	(2.0)	(2.0)	(2.0)			5.9	(2.0)	(2.0)	3.7	
	3	FRN003C1 ■-4U				4.4						8.2			5.5	
	5	FRN005C1 ■-4U				7.3						13.0			9	
Single-phase 230 V	1/8	FRNF12C1 ■-7U				1.1						1.8			0.8	
	1/4	FRNF25C1 ■-7U				2.0	0.003					3.3			1.5	
	1/2	FRNF50C1 ■-7U	0.003			3.5	(2.0)	0.003				5.4			3.0	
	1	FRN001C1 ■-7U	(2.0)	0.003	0.003	6.4		(2.0)	0.003			9.7	0.003	0.003	5.0	
	2	FRN002C1 ■-7U		(2.0)	(2.0)	11.7			(2.0)			16.4	(2.0)	(2.0)	8.0	
	3	FRN003C1 ■-7U	0.005			17.5	0.009	0.005				24.8			11	

Table 6.2 Cont. (for DC reactor, braking resistor, control circuits, and inverter grounding)

Power supply voltage	Applicable motor rating (HP)	Inverter type	Recommended wire size [inch ² (mm ²)]													
			DC reactor [P1, P(+)]				Braking resistor [P(+), DB]				Control circuit			Inverter grounding [G]		
			Allowable temp.*1			Current	Allowable temp.*1			Current	Allowable temp.*1			Allowable temp.*1		
			60°C (140°F)	75°C (167°F)	90°C (194°F)	(A)	60°C (140°F)	75°C (167°F)	90°C (194°F)	(A)	60°C (140°F)	75°C (167°F)	90°C (194°F)	60°C (140°F)	75°C (167°F)	90°C (194°F)
Three-phase 230 V	1/8	FRNF12C1 ■-2U				0.70										
	1/4	FRNF25C1 ■-2U				1.1	-	-	-							
	1/2	FRNF50C1 ■-2U				2.0										
	1	FRN001C1 ■-2U	0.003	0.003	0.003	3.7				0.001	0.001	0.001	0.003	0.003	0.003	
	2	FRN002C1 ■-2U	(2.0)	(2.0)	(2.0)	7.0	0.003	0.003	0.003	(0.5)	(0.5)	(0.5)	(2.0)	(2.0)	(2.0)	
	3	FRN003C1 ■-2U				10.2	(2.0)	(2.0)	(2.0)							
Three-phase 460 V	1/2	FRNF50C1 ■-4U				1.0										
	1	FRN001C1 ■-4U	0.003	0.003	0.003	1.9	0.003	0.003	0.003	0.001	0.001	0.001	0.003	0.003	0.003	
	2	FRN002C1 ■-4U	(2.0)	(2.0)	(2.0)	3.6	(2.0)	(2.0)	(2.0)	(0.5)	(0.5)	(0.5)	(2.0)	(2.0)	(2.0)	
	3	FRN003C1 ■-4U				5.3										
	5	FRN005C1 ■-4U				9.0										
Single-phase 230 V	1/8	FRNF12C1 ■-7U				1.1										
	1/4	FRNF25C1 ■-7U				2.0	-	-	-							
	1/2	FRNF50C1 ■-7U	0.003			3.5				0.001	0.001	0.001	0.003	0.003	0.003	
	1	FRN001C1 ■-7U	(2.0)	0.003	0.003	6.4	0.003	0.003	0.003	(0.5)	(0.5)	(0.5)	(2.0)	(2.0)	(2.0)	
	2	FRN002C1 ■-7U		(2.0)	(2.0)	11.7	(2.0)	(2.0)	(2.0)							
	3	FRN003C1 ■-7U	0.005			17.5							0.005			

*1 Assuming the use of bare wiring (without rack or duct): 600 V class of vinyl-insulated IV wires for 60°C (140°F), 600 V class of polyethylene-insulated HIV wires for 75°C (167°F), and 600 V class of polyethylene-insulated cross-link wires for 90°C (194°F).

Notes: 1) A box (■) in the above tables replaces S or E depending on enclosure.



If environmental requirements such as power supply voltage and ambient temperature differ from those listed above, select wires suitable for your system by referring to Table 6.1 and Appendices, App. F "Allowable Current of Insulated Wires."

■ If the internal temperature of your power control cabinet is 40°C (104°F) or below

Table 6.3 Wire Size (for main circuit power input and inverter output)

Power supply voltage	Applicable motor rating (HP)	Inverter type	Recommended wire size [inch ² (mm ²)]											
			Main circuit power input [L1/R, L2/S, L3/T] or [L1/L, L2/N]						Inverter output [U, V, W]					
			w/ DC reactor (DCR)			w/o DC reactor (DCR)			w/ DC reactor (DCR)			w/o DC reactor (DCR)		
			Allowable temp.*1			Current (A)	Allowable temp.*1			Current (A)	Allowable temp.*1			Current (A)
60°C (140°F)	75°C (167°F)	90°C (194°F)	60°C (140°F)	75°C (167°F)	90°C (194°F)		60°C (140°F)	75°C (167°F)	90°C (194°F)					
Three-phase 230 V	1/8	FRNF12C1■-2U				0.57				1.1				0.8
	1/4	FRNF25C1■-2U				0.93				1.8				1.5
	1/2	FRNF50C1■-2U				1.6	0.003			3.1				3.0
	1	FRN001C1■-2U	0.003	0.003	0.003	3.0	(2.0)	0.003	0.003	5.3	0.003	0.003	0.003	5.5
	2	FRN002C1■-2U	(2.0)	(2.0)	(2.0)	5.7		(2.0)	(2.0)	9.5	(2.0)	(2.0)	(2.0)	8.0
	3	FRN003C1■-2U				8.3				13.2				11
	5	FRN005C1■-2U				14.0	0.005 (3.5)			22.2				17
Three-phase 460 V	1/2	FRNF50C1■-4U				0.85				1.7				1.5
	1	FRN001C1■-4U	0.003	0.003	0.003	1.6	0.003	0.003	0.003	3.1	0.003	0.003	0.003	2.5
	2	FRN002C1■-4U	(2.0)	(2.0)	(2.0)	3.0	(2.0)	(2.0)	(2.0)	5.9	(2.0)	(2.0)	(2.0)	3.7
	3	FRN003C1■-4U				4.4				8.2				5.5
	5	FRN005C1■-4U				7.3				13.0				9
Single-phase 230 V	1/8	FRNF12C1■-7U				1.1				1.8				0.8
	1/4	FRNF25C1■-7U				2.0				3.3				1.5
	1/2	FRNF50C1■-7U				3.5	0.003			5.4				3.0
	1	FRN001C1■-7U	0.003	0.003	0.003	6.4	(2.0)	0.003	0.003	9.7	0.003	0.003	0.003	5.0
	2	FRN002C1■-7U	(2.0)	(2.0)	(2.0)	11.6		(2.0)	(2.0)	16.4	(2.0)	(2.0)	(2.0)	8.0
	3	FRN003C1■-7U				17.5	0.005 (3.5)			24.8				11

Table 6.3 Cont. (for DC reactor, braking resistor, control circuit, and inverter grounding)

Power supply voltage	Applicable motor rating (HP)	Inverter type	Recommended wire size [inch ² (mm ²)]													
			DC reactor [P1, P(+)]			Braking resistor [P(+), DB]				Control circuit			Inverter grounding [G]			
			Allowable temp.*1			Current (A)	Allowable temp.*1			Current (A)	Allowable temp.*1			Allowable temp.*1		
			60°C (140°F)	75°C (167°F)	90°C (194°F)		60°C (140°F)	75°C (167°F)	90°C (194°F)		60°C (140°F)	75°C (167°F)	90°C (194°F)	60°C (140°F)	75°C (167°F)	90°C (194°F)
Three-phase 230 V	1/8	FRNF12C1■-2U				0.7										
	1/4	FRNF25C1■-2U				1.1										
	1/2	FRNF50C1■-2U				2.0				1.2						
	1	FRN001C1■-2U	0.003	0.003	0.003	3.7				1.6	0.001	0.001	0.001	0.003	0.003	0.003
	2	FRN002C1■-2U	(2.0)	(2.0)	(2.0)	7.0	0.003	0.003	0.003	3.6	(0.5)	(0.5)	(0.5)	(2.0)	(2.0)	(2.0)
	3	FRN003C1■-2U				10.2				3.5						
Three-phase 460 V	1/2	FRNF50C1■-4U				1.0				0.8						
	1	FRN001C1■-4U	0.003	0.003	0.003	1.9	0.003	0.003	0.003	1.1	0.001	0.001	0.001	0.003	0.003	0.003
	2	FRN002C1■-4U	(2.0)	(2.0)	(2.0)	3.6	(2.0)	(2.0)	(2.0)	1.8	(0.5)	(0.5)	(0.5)	(2.0)	(2.0)	(2.0)
	3	FRN003C1■-4U				5.3				1.8						
	5	FRN005C1■-4U				9.0				2.1						
Single-phase 230 V	1/8	FRNF12C1■-7U				1.1										
	1/4	FRNF25C1■-7U				2.0										
	1/2	FRNF50C1■-7U				3.5				0.82	0.001	0.001	0.001	0.003	0.003	0.003
	1	FRN001C1■-7U	0.003	0.003	0.003	6.4	0.003	0.003	0.003	1.4	(0.5)	(0.5)	(0.5)	(2.0)	(2.0)	(2.0)
	2	FRN002C1■-7U	(2.0)	(2.0)	(2.0)	11.7	(2.0)	(2.0)	(2.0)	1.4						
3	FRN003C1■-7U				17.5				1.7							

*1 Assuming the use of bare wiring (without rack or duct): 600 V class of vinyl-insulated IV wires for 60°C (140°F), 600 V class of polyethylene-insulated HIV wires for 75°C (167°F), and 600 V class of polyethylene-insulated cross-link wires for 90°C (194°F).

Notes: 1) A box (■) in the above tables replaces S or E depending on enclosure.

 If environmental requirements such as power supply voltage and ambient temperature differ from those listed above, select wires suitable for your system by referring to Table 6.1 and Appendices, App. F "Allowable Current of Insulated Wires."

6.2.2 Crimp terminals

Table 6.4 lists the recommended ring tongue crimp terminals that can be specified by the wires and screws to be used for your inverter model.

Table 6.4 Crimp Terminal Size

Wire size [inch ² (mm ²)]	Terminal screw size	Ring tongue crimp terminal
0.001 (0.5)	M3.5	1.25 - 3.5
	M4	1.25 - 4
0.001 (0.75)	M3.5	1.25 - 3.5
	M4	1.25 - 4
0.002 (1.25)	M3.5	1.25 - 3.5
	M4	1.25 - 4
0.003 (2.0)	M3.5	2 - 3.5
	M4	2 - 4
0.005/0.009 (3.5/5.5)	M4	4 - 5.5

 Refer to Chapter 8, Section 8.4.3 "Terminal arrangement diagram and screw specifications" to select the correct terminal screw size.

6.3 Peripheral Equipment

[1] Molded case circuit breaker (MCCB), ground-fault circuit interrupter (GFCI) and magnetic contactor (MC)

[1.1] Functional overview

■ MCCBs and GFCIs*

*With overcurrent protection

Molded Case Circuit Breakers (MCCBs) are designed to protect the power circuits between the power supply and inverter's main circuit terminals (L1/R, L2/S and L3/T for three phase, or L1/L and L2/N for single-phase power source) from overload or short-circuit, which in turn prevents secondary accidents caused by the inverter malfunctioning.

Ground-Fault Circuit Interrupters (GFCIs) function in the same way as MCCBs.

Built-in overcurrent/overload protective functions protect the inverter itself from failures related to its input/output lines.

■ MCs

An MC can be used at both the power input and output sides of the inverter. At each side, the MC works as described below. When inserted in the output circuit of the inverter, the MC can also switch the motor drive power source between the inverter output and commercial power lines.

At the power source side

Insert an MC in the power source side of the inverter in order to:

- (1) Forcibly cut off the inverter from the power source (generally, commercial/factory power lines) with the protective function built into the inverter, or with the external signal input.
- (2) Stop the inverter operation in an emergency when the inverter cannot interpret the stop command due to internal/external circuit failures.
- (3) Cut off the inverter from the power source when the MCCB inserted in the power source side cannot cut it off for maintenance or inspection purpose. For the purpose only, it is recommended that you use an MC capable of turning the MC ON/OFF manually.

 **Note** When your system requires starting/stopping the motor(s) driven by the inverter with the MC, the frequency of the starting/stopping operation should be once or less per hour. The more frequent the operation, the shorter operation life of the MC and capacitor/s used in the DC link bus due to thermal fatigue caused by the frequent charging of the current flow. It is recommended that terminal commands (FWD), (REV) and (HLD) for 3-wire operation or the keypad be used for starting/stopping the motor.

At the output side

Insert an MC in the power output side of the inverter in order to:

- (1) Prevent externally turned-around current from being applied to the inverter power output terminals (U, V, and W) unexpectedly. An MC should be used, for example, if a circuit that switches the motor driving power source between the inverter output and commercial power lines is connected to the inverter.

 **Tip** As application of the external current to the inverter's secondary (output) circuits may break the Insulated Gate Bipolar Transistors (IGBTs), MCs should be used in the power control system circuits to switch the motor drive power source to the commercial power lines after the motor has come to a complete stop. Also ensure that voltage is never mistakenly applied to the inverter output terminals due to unexpected timer operation, or similar.

- (2) Drive more than one motor selectively by a single inverter.
- (3) Selectively cut off the motor whose thermal overload relay or equivalent devices have been activated.

Driving the motor using commercial power lines

MCs can also be used to switch the power source of the motor driven by the inverter to a commercial power source.

Select the MC so as to satisfy the rated currents listed in Table 6.1, which are the most critical RMS currents for using the inverter. For switching the motor drive source between the inverter output and commercial power lines, use the MC of class AC3 specified by JIS C8325 in the commercial line side.

[1.2] Connection example and criteria for selection of circuit breakers

Figure 6.2 shows a connection example for MCCB or GFCI (with overcurrent protection) in the inverter input circuit. Table 6.5 lists the rated current for the MCCB and corresponding inverter models. Table 6.6 lists the applicable grades of GFCI sensitivity.

⚠ WARNING
Insert an MCCB or GFCI (with overcurrent protection) recommended for each inverter for its input circuits. Do not use an MCCB or GFCI of a higher rating than that recommended.
Doing so could result in a fire.

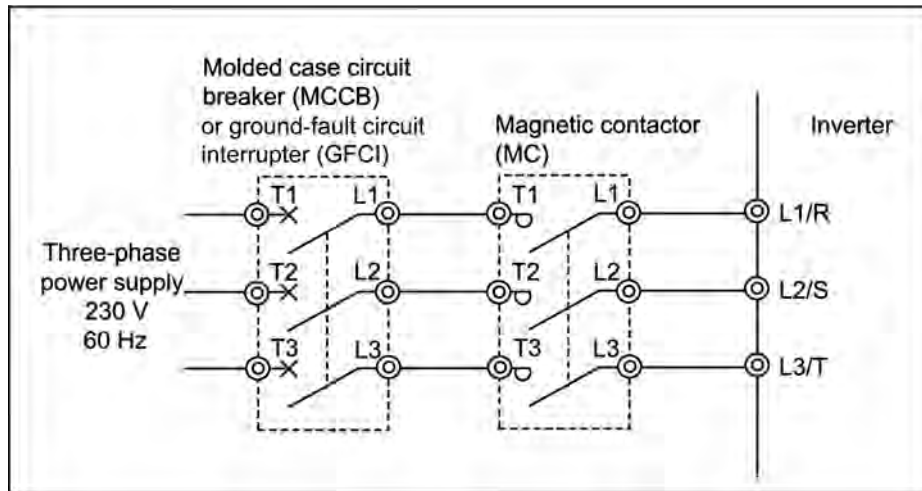
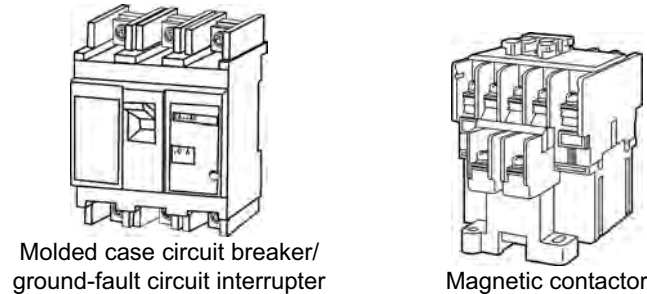

Figure 6.2 External Views of Molded Case Circuit Breaker/Ground-Fault Circuit Interrupter, Magnetic Contactor and Connection Example

Table 6.5 Rated Current of Molded Case Circuit Breaker/Ground-Fault Circuit Interrupter and Magnetic Contactor

Power supply voltage	Applicable motor rating (HP)	Inverter type	MCCB, GFCI Rated current (A)		Magnetic contactor type MC1 (for input circuit)		Magnetic contactor type MC2 (for output circuit)
			DC reactor (DCR)		DC reactor (DCR)		
			w/ DCR	w/o DCR	w/ DCR	w/o DCR	
Three-phase 230 V	1/8	FRNF12C1 ■-2U	5 (6)	5 (6)	SC-05	SC-05	SC-05
	1/4	FRNF25C1 ■-2U					
	1/2	FRNF50C1 ■-2U					
	1	FRNF001C1 ■-2U	10	10			
	2	FRNF002C1 ■-2U		15 (16)			
	3	FRNF003C1 ■-2U		20 (25)			
	5	FRNF005C1 ■-2U		20 (25)			
Three-phase 460 V	1/2	FRNF50C1 ■-4U	5 (6)	5 (6)	SC-05	SC-05	SC-05
	1	FRNF001C1 ■-4U					
	2	FRNF002C1 ■-4U					
	3	FRNF003C1 ■-4U	10	15 (16)			
	5	FRNF005C1 ■-4U	10	20 (25)			
Single-phase 230 V	1/8	FRNF12C1 ■-7U	5 (6)	5 (6)	SC-05	SC-05	SC-05
	1/4	FRNF25C1 ■-7U					
	1/2	FRNF50C1 ■-7U					
	1	FRNF001C1 ■-7U	10	15 (16)			
	2	FRNF002C1 ■-7U	15 (16)	20 (25)			
	3	FRNF003C1 ■-7U	20 (25)	30 (35)			

- The above table lists the rated current of MCCBs and GFCIs to be used in the power control cabinet with an internal temperature of lower than 50°C (120°F). The rated current is factored by a correction coefficient of 0.85 as the MCCBs' and GFCIs' original rated current is specified when using them in an ambient temperature of 40°C (104°F) or lower. Select an MCCB and/or GFCI suitable for the actual short-circuit breaking capacity needed for your power systems.
- For the selection of the MC type, it is assumed that the **600V HIV (allowable ambient temperature: 75°C (167°F))** wires for the power input/output of the inverter are used. If an MC type for another class of wires is selected, the wire size suitable for the terminal size of both the inverter and the MC type should be taken into account.
- Use GFCIs with overcurrent protection.
- To protect your power systems from secondary accidents caused by the broken inverter, use an MCCB and/or GFCI with the rated current listed in the above table. Do not use an MCCB or GFCI with a rating higher than that listed.

Notes: 1) A box (■) in the above table replace S or E depending on enclosure.

2) Values in parentheses () in the above table denote rated currents for the European version.

Table 6.6 lists the relationship between the rated leakage current sensitivity of GFCIs (with overcurrent protection) and wiring length of the inverter output circuits. Note that the sensitivity levels listed in the table are estimated values based on the results obtained by the test setup in the Fuji laboratory where each inverter drives a single motor.

Table 6.6 Rated Current Sensitivity of Ground-Fault Circuit Interrupter (GFCIs)

Power supply voltage	Applicable motor rating (HP)	Rated current of applicable motor (A)	Wiring length and current sensitivity					
			33 ft (10 m)	98 ft (30 m)	164 ft (50 m)	328 ft (100 m)	656 ft (200 m)	984 ft (300 m)
Three-phase 230 V	1/8	0.68						
	1/4	1.4						
	1/2	2.3						
	1	3.6						
	2	6.5		30mA		100mA		200mA
	3	9.2						
	5	15						
	7.5	22						
Three-phase 460 V	10	29						
	1/2	1.2						
	1	1.8						
	2	3.3						
	3	4.6		30mA		100mA	200mA	500mA
	5	7.5						
Single-phase 230 V	7.5	11						
	10	14.5						
	1/8	0.68						
	1/4	1.4						
	1/2	2.3						
	1	3.6		30mA		100mA		200mA
2	6.5							
3	9.2							

- Values listed above were obtained using Fuji GFCI EG or SG series applied to the test setup.
- The rated current of applicable motor rating indicates values for Fuji standard motor (4 poles, 50 Hz and 230 V 3-phase).
- The leakage current is calculated based on grounding of the single wire for 230V Δ type and the neutral wire for 460V Y type power lines.
- Values listed above are calculated based on the static capacitance to the earth when the 600V class of vinyl-insulated IV wires are used in a metal conduit laid directly on the earth.
- Wiring length is the total length of wiring between the inverter and motor. If more than one motor is to be connected to a single inverter, the wiring length should be the total length of wiring between the inverter and motors.

[2] Surge killers

A surge killer eliminates surge currents induced by lightning and noise from the power supply lines. Use of a surge killer is effective in preventing the electronic equipment, including inverters, from damage or malfunctioning caused by such surges and/or noise.

The applicable model of surge killer is the FSL-323. Figure 6.3 shows its external dimensions and a connection example. Refer to the catalog "Fuji Noise Suppressors (SH310: Japanese edition only)" for details. These products are available from Fuji Electric Technica Co., Ltd.

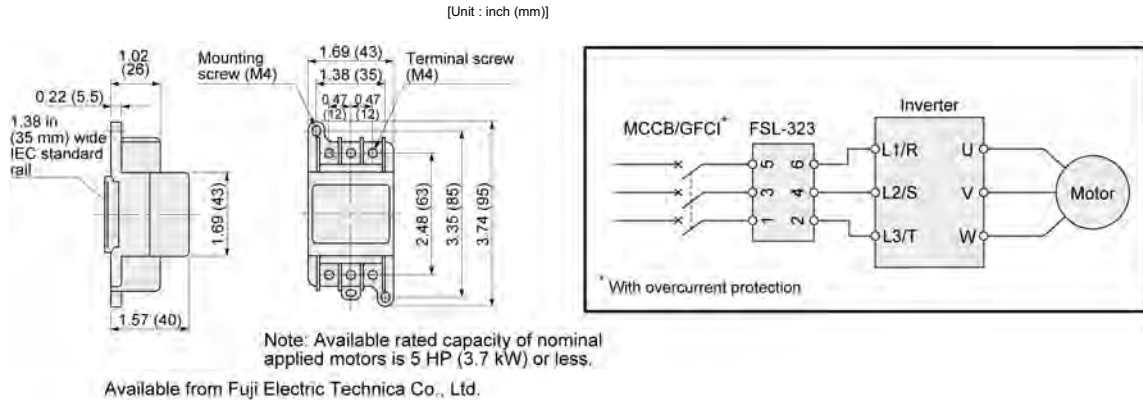

Figure 6.3 Dimensions of Surge Killer and Connection Example

[3] Arresters

An arrester suppresses surge currents and noise invaded from the power supply lines. Use of an arrester is effective in preventing electronic equipment, including inverters, from damage or malfunctioning caused by such surges and/or noise.

Applicable arrester models are the CN23232 and CN2324E. Figure 6.4 shows their external dimensions and connection examples. Refer to the catalog "Fuji Noise Suppressors (SH310: Japanese edition only)" for details. These products are available from Fuji Electric Technica Co., Ltd.

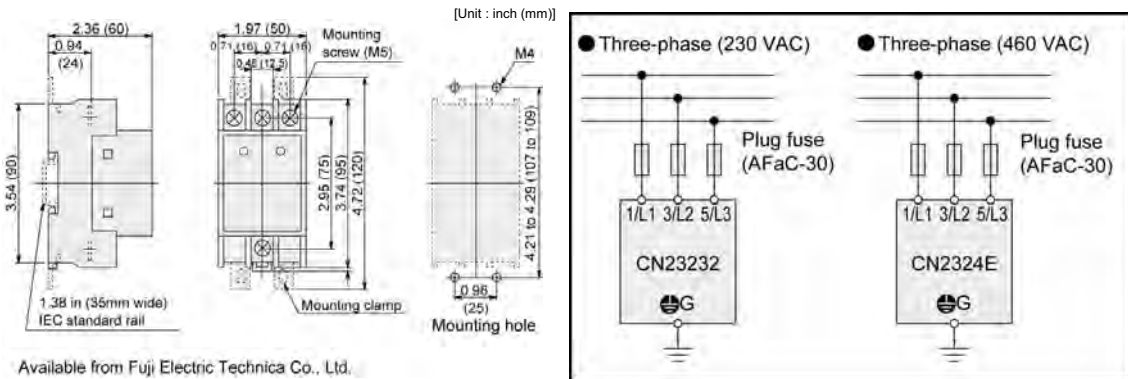

Figure 6.4 Arrester Dimensions and Connection Examples

[4] Surge absorbers

A surge absorber suppresses surge currents and noise from the power lines to ensure effective protection of your power system from the malfunctioning of the magnetic contactors, mini-control relays and timers.

Applicable surge absorber models are the S2-A-O and S1-B-O. Figure 6.5 shows their external dimensions. Refer to the catalog "Fuji Noise Suppressors (SH310: Japanese edition only)" for details. The surge absorbers are available from Fuji Electric Technica Co., Ltd.

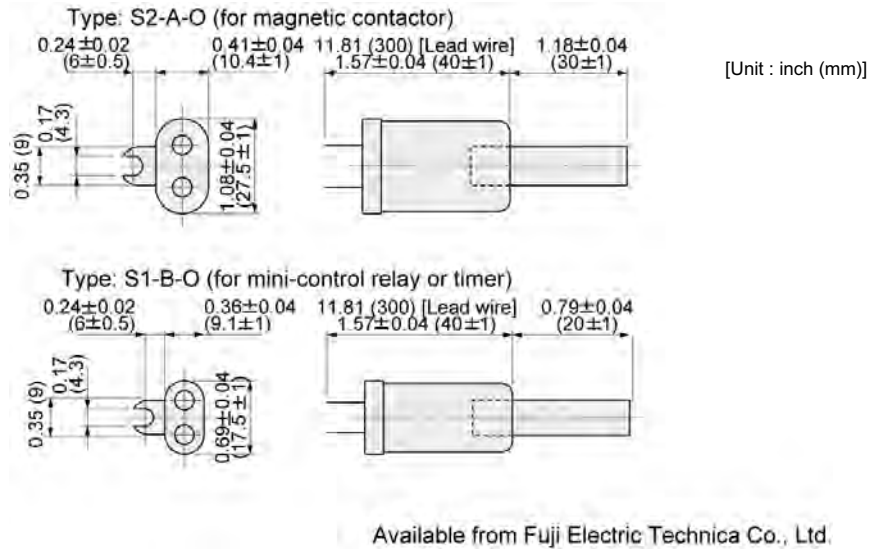



Figure 6.5 Surge Absorber Dimensions

6.4 Selecting Options

6.4.1 Peripheral equipment options

[1] Braking resistors

A braking resistor converts regenerative energy generated from deceleration of the motor and converts it to heat for consumption. Use of a braking resistor results in improved deceleration performance of the inverter.

 Refer to Chapter 7, Section 7.2 "Selecting a Braking Resistor."

[1.1] Standard model

The standard model of a braking resistor integrates a facility that detects the temperature on the heat sink of the resistor and outputs a digital ON/OFF signal if the temperature exceeds the specified level (as an overheating warning signal). To ensure that the signal is recognized at one of the digital input terminals of the FRENIC-Mini, assign the external alarm (THR) to any of terminals [X1] to [X3], [FWD] and [REV]. Connect the assigned terminal [1] of the braking resistor. Upon detection of the warning signal (preset detection level: 150°C (302°F)), the inverter simultaneously transfers to Alarm mode, displays alarm  on the LED monitor and shuts down its power output.

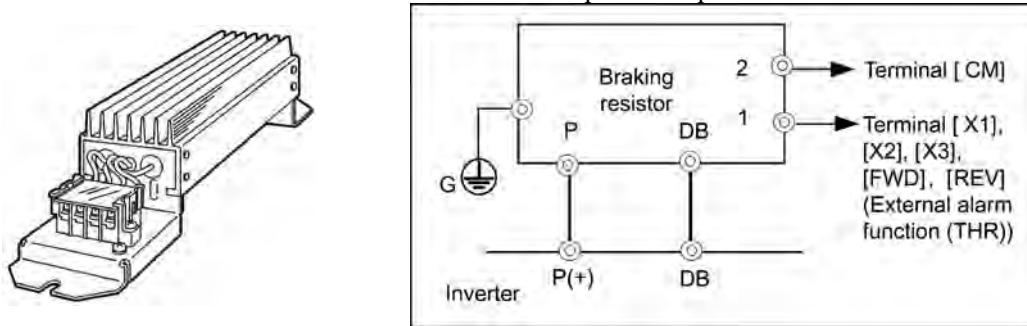

Figure 6.6 Braking Resistor (Standard Model) and Connection Example

Table 6.7 Braking Resistor (Standard Model)

Power supply voltage	Inverter type	Option			Max. braking torque (%)	Continuous braking (100% torque conversion value)		Repetitive braking (100 sec or less cycle)			
		Braking resistor				Discharging capability (kWs)	Braking time (s)	Average loss (HP)	Duty cycle (%ED)		
		Type	Q'ty	Resistance (Ω)							
Three-phase 230 V	FRNF50C1■-2U	DB0.75-2	1	100	150	35.6 (4.02)	29.4 (3.32)	9	45	0.059	22
	FRNF001C1■-2U					67.0 (7.57)	55.3 (6.25)				
	FRNF002C1■-2U	DB2.2-2	1	40		133 (15.0)	110 (12.4)	34	0.101	10	
	FRNF003C1■-2U					195 (22.0)	161 (18.2)	33	30	0.103	7
	FRNF005C1■-2U	DB3.7-2	1	33		328 (37.1)	270 (30.5)	37	20	0.124	5
Three-phase 460 V	FRNF50C1■-4U	DB0.75-4	1	200	150	35.6 (4.02)	29.4 (3.32)	9	45	0.059	22
	FRNF001C1■-4U					67.0 (7.57)	55.3 (6.25)				
	FRNF002C1■-4U	DB2.2-4	1	160		133 (15.0)	110 (12.4)	34	0.101	10	
	FRNF003C1■-4U					195 (22.0)	161 (18.2)	33	30	0.103	7
	FRNF005C1■-4U	DB3.7-4	1	130		328 (37.1)	270 (30.5)	37	20	0.124	5
Single-phase 230 V	FRNF50C1■-7U	DB0.75-2	1	100	150	35.6 (4.02)	29.4 (3.32)	9	45	0.059	22
	FRNF001C1■-7U					67.0 (7.57)	55.3 (6.25)				
	FRNF002C1■-7U	DB2.2-2	1	40		133 (15.0)	110 (12.4)	34	0.101	10	
	FRNF003C1■-7U					195 (22.0)	161 (18.2)	33	30	0.103	7

Notes: 1) A box (■) in the above table replaces S or E depending on enclosure.

[1.2] 10%ED model

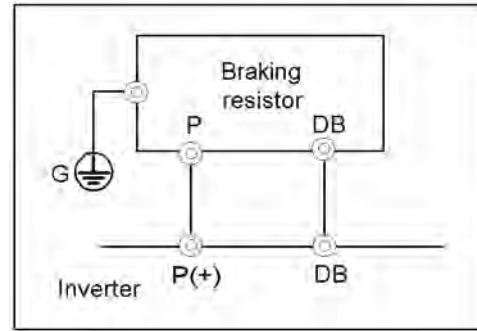
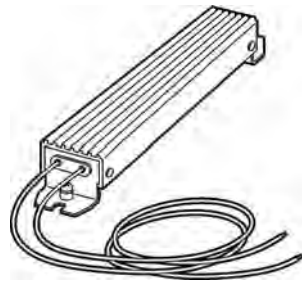

Figure 6.7 Braking Resistor (10 %ED Model) and Connection Example

Table 6.8 Braking Resistor (10 %ED Model)

Power supply voltage	Inverter type	Option			Max. braking torque (%)		Continuous braking (100% torque conversion value)		Repetitive braking (100 sec or less cycle)				
		Braking resistor			50 Hz	60 Hz	Discharging capability (kW)	Braking time (s)	Average loss (HP)	Duty cycle (%ED)			
		Type	Qty	Resistance (Ω)	lb-in (N·m)	lb-in (N·m)							
Three-phase 230 V	FRNF50C1■-2U	DB0.75-2C	1	100	150	35.6 (4.02)	29.4 (3.32)	9	45	0.027	10		
	FRN001C1■-2U					67.0 (7.57)	55.3 (6.25)					17	
	FRN002C1■-2U	DB2.2-2C	1	40		133 (15.0)	110 (12.4)	34				30	0.101
	FRN003C1■-2U					195 (22.0)	161 (18.2)	33					
	FRN005C1■-2U					DB3.7-2C	1	33					
Three-phase 460 V	FRNF50C1■-4U	DB0.75-4C	1	200	150	35.6 (4.02)	29.4 (3.32)	9	45	0.027	10		
	FRN001C1■-4U					67.0 (7.57)	55.3 (6.25)					17	
	FRN002C1■-4U	DB2.2-4C	1	160		133 (15.0)	110 (12.4)	34				30	0.101
	FRN003C1■-4U					195 (22.0)	161 (18.2)	33					
	FRN005C1■-4U					DB3.7-4C	1	130					
Single-phase 230 V	FRNF50C1■-7U	DB0.75-2C	1	100	150	35.6 (4.02)	29.4 (3.32)	9	45	0.027	10		
	FRN001C1■-7U					67.0 (7.57)	55.3 (6.25)					17	
	FRN002C1■-7U	DB2.2-2C	1	40		133 (15.0)	110 (12.4)	34				30	0.501
	FRN003C1■-7U					195 (22.0)	161 (18.2)	33					

Notes: 1) A box (■) in the above table replaces S or E depending on enclosure.

The 10 %ED braking resistor does not support overheating detection or warning output, so an electronic thermal overload relay needs to be set up using function codes F50 and F51 to protect the braking resistor from overheating.

[1.3] Compact model

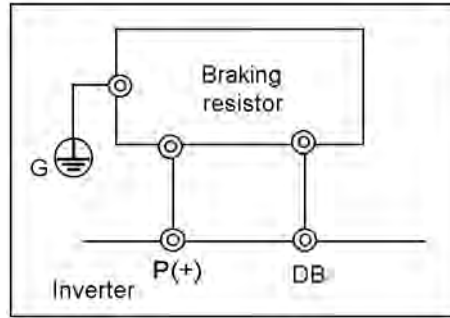
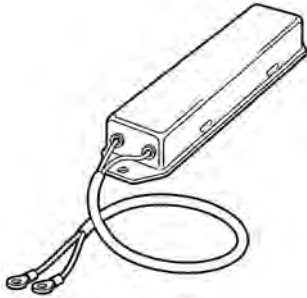

Figure 6.8 Braking Resistor (Compact Model) and Connection Example

Table 6.9 Braking Resistor (Compact Model)

Power supply voltage	Item		Model: TK80W120Ω				
230 V	Resistor	Capacity (HP)	0.107				
		Resistance (Ω)	120				
	Applicable inverter model		FRNF50 C1■-2U	FRN001 C1■-2U	FRN002 C1■-2U	FRN003 C1■-2U	FRN005 C1■-2U
	Applicable motor output (HP)		1/2	1	2	3	5
	Average braking torque (%)		150	150	150	100	100
	Allowable braking properties	Allowable duty cycle (%)	15	5	5	5	5
		Allowable continuous braking time	15 sec	15 sec	10 sec	10 sec	10 sec
	Braking unit		Not required				

Notes: 1) A box (■) in the above table replaces S or E depending on enclosure.

Note This braking resistor is not suitable for use with the 460V class of inverters.

[2] DC reactors (DCRs)

A DCR is mainly used for power supply normalization and for supplied power factor improvement (for reducing harmonic components).

■ For power supply normalization

- Use a DCR when the capacity of a power supply transformer exceeds 500 kVA and is 10 times or more the rated inverter capacity. In this case, the percentage-reactance of the power source decreases, and harmonic components and their peak levels increase. These factors may break rectifiers or capacitors in the converter section of inverter, or decrease the capacitance of the capacitor (which can shorten the inverter's service life).
- Also use a DCR when there are thyristor-driven loads or when phase-advancing capacitors are being turned ON/OFF.
- Use a DCR when the interphase voltage unbalance ratio of the inverter power source exceeds 2%.

$$\text{Interphase voltage unbalance (\%)} = \frac{\text{Max. voltage (V)} - \text{Min. voltage (V)}}{3\text{-phase average voltage (V)}} \times 67$$

■ For supplied power factor improvement (for suppressing harmonics)

Generally a capacitor is used to improve the power factor of the load, however, it cannot be used in a system that includes an inverter. Using a DCR increases the reactance of inverter's power source so as to decrease harmonic components on the power source lines and improve the power factor of inverter. Using a DCR improves the input power factor to approximately 95%.



- At the time of shipping, a short bar is connected across terminals P1 and P (+) on the terminal block. Remove the jumper bar when connecting a DCR.
- If a DCR is not going to be used, do not remove the jumper bar.

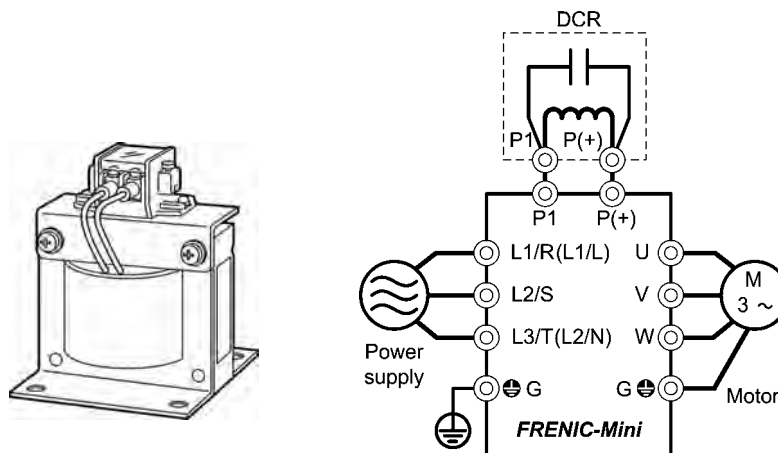

For three-phase 230 V/460 V or single-phase 230 V

Figure 6.9 External View of a DC Reactor (DCR) and Connection Example

Table 6.10 DC Reactors (DCRs)

Power supply voltage	Applicable motor rating (HP)	Inverter type	DC reactor (DCR)				
			Type	Rated current (A)	Inductance (mH)	Coil resistance (mΩ)	Generated loss (W)
Three-phase 230 V	1/8	FRNF12C1■-2U	DCR2-0.2	1.5	20	660	0.8
	1/4	FRNF25C1■-2U					1.6
	1/2	FRNF50C1■-2U	DCR2-0.4	3.0	12	280	1.9
	1	FRNF001C1■-2U	DCR2-0.75	5.0	7.0	123	2.8
	2	FRNF002C1■-2U	DCR2-1.5	8.0	4.0	57.5	4.6
	3	FRNF003C1■-2U	DCR2-2.2	11	3.0	43	6.7
	5	FRNF005C1■-2U	DCR2-3.7	18	1.7	21	8.8
Three-phase 460 V	1/2	FRNF50C1■-4U	DCR4-0.4	1.5	50	970	2.0
	1	FRNF001C1■-4U	DCR4-0.75	2.5	30	440	2.5
	2	FRNF002C1■-4U	DCR4-1.5	4.0	16	235	4.8
	3	FRNF003C1■-4U	DCR4-2.2	5.5	12	172	6.8
	5	FRNF005C1■-4U	DCR4-3.7	9.0	7.0	74.5	8.1
Single-phase 230 V	1/8	FRNF12C1■-7U	DCR2-0.2	1.5	20	660	1.6
	1/4	FRNF25C1■-7U	DCR2-0.4	3.0	12	280	1.9
	1/2	FRNF50C1■-7U	DCR2-0.75	5.0	7.0	123	2.8
	1	FRNF001C1■-7U	DCR2-1.5	8.0	4.0	57.5	4.6
	2	FRNF002C1■-7U	DCR2-3.7	18	1.7	21	8.8
	3	FRNF003C1■-7U					

Note 1: Generated losses listed in the above table are approximate values that are calculated according to the following conditions:

- The power source is 3-phase 230 V/460 V 60 Hz with 0% interphase voltage unbalance ratio.
- The power source capacity uses the larger of either 500 kVA or 10 times the rated capacity of the inverter.
- The motor is a 4-pole standard model at full load (100%).
- An AC reactor (ACR) is not connected.

Note 2: A box (■) in the above table replaces S or E depending on enclosure.

[3] AC reactors (ACRs)

Use an ACR when the converter part of the inverter should supply very stable DC power, for example, in DC link bus operation (shared PN operation). Generally, ACRs are used for correction of voltage waveform and power factor or for power supply normalization, but not for suppressing harmonic components in the power lines. For suppressing harmonic components, use a DCR.

An ACR should be also used when the power source is extremely unstable; for example, when the power source involves an extremely large interphase voltage unbalance.

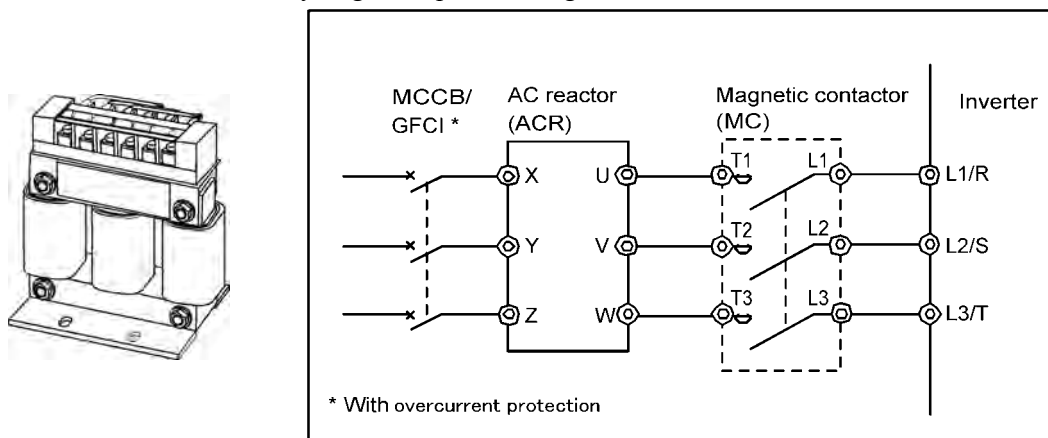

Figure 6.10 External View of AC Reactor (ACR) and Connection Example

Table 6.11 AC Reactor (ACR)

Power supply voltage	Applicable motor rating (HP)	Inverter type	AC reactor (ACR)				
			Type	Rated current (A)	Reactance (mΩ/phase)		Generated loss (W)
					50 Hz	60 Hz	
Three-phase 230 V	1/8	FRNF12C1■-2U	ACR2-0.4A	3	917	1100	2.5
	1/4	FRNF25C1■-2U					5
	1/2	FRNF50C1■-2U					10
	1	FRN001C1■-2U	ACR2-0.75A	5	493	592	12
	2	FRN002C1■-2U	ACR2-1.5A	8	295	354	14
	3	FRN003C1■-2U	ACR2-2.2A	11	213	256	16
	5	FRN005C1■-2U	ACR2-3.7A	17	218	153	23
Three-phase 460 V	1/2	FRNF50C1■-4U	ACR4-0.75A	2.5	1920	2300	5
	1	FRN001C1■-4U					10
	2	FRN002C1■-4U	ACR4-1.5A	3.7	1160	1390	11
	3	FRN003C1■-4U	ACR4-2.2A	5.5	851	1020	14
	5	FRN005C1■-4U	ACR4-3.7A	9	512	615	17
Single-phase 230 V	1/8	FRNF12C1■-7U	ACR2-0.4A	3	917	1100	5
	1/4	FRNF25C1■-7U					10
	1/2	FRNF50C1■-7U	ACR2-0.75A	5	493	592	12
	1	FRN001C1■-7U	ACR2-1.5A	8	295	354	14
	2	FRN002C1■-7U	ACR2-2.2A	11	213	256	16
	3	FRN003C1■-7U	ACR2-3.7A	17	218	262	23

Note 1: Generated losses listed in the above table are approximate values that are calculated according to the following conditions:

- The power source is 3-phase 230 V/460 V 50 Hz with 0% interphase voltage unbalance ratio.
- The power source capacity uses the larger of either 500 kVA or 10 times the rated capacity of the inverter.
- The motor is a 4-pole standard model at full load (100%).

Note 2: A box (■) in the above table replaces S or E depending on enclosure.

[4] Output circuit filters (OFLs)

Insert an OFL in the inverter power output circuit to:

- Suppress the voltage fluctuation at the motor power terminals
This protects the motor from insulation damage caused by the application of high voltage surge currents from the 400 V class of inverters.
- Suppress leakage current (due to higher harmonic components) from the inverter output lines
This reduces the leakage current when the motor is connected by long power feed lines. Keep the length of the power feed line less than 1300 ft (400 m).
- Minimize radiation and/or induction noise issued from the inverter output lines
OFLs are effective noise suppression device for long wiring applications such as that used at plants.

Note Use an ACR within the allowable carrier frequency range specified by function code F26. Otherwise, the filter will overheat.

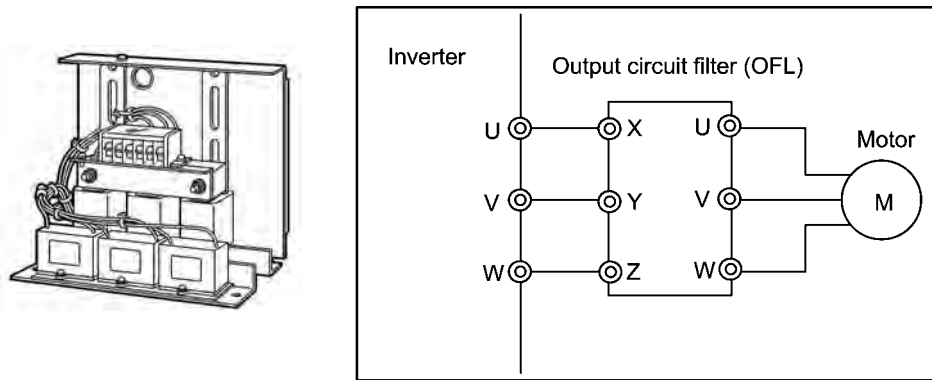

Figure 6.11 External View of Output Circuit Filter (OFL) and Connection Example

Table 6.12 Output Circuit Filter (OFL)

Power supply voltage	Applicable motor rating (HP)	Inverter type	Filter type	Rated current (A)	Overload capability	Inverter power input voltage	Carrier frequency - allowable range (kHz)	Maximum frequency (Hz)
Three-phase 230 V	1/8	FRNF12C1■-2U	OFL-0.4-2	3	150 % for 1 min. 200 % for 0.5 sec	Three-phase 200 to 240 V 50/60 Hz	8 to 15	400
	1/4	FRNF25C1■-2U						
	1/2	FRNF50C1■-2U						
	1	FRN001C1■-2U	OFL-1.5-2	8				
	2	FRN002C1■-2U						
	3	FRN003C1■-2U						
	5	FRN005C1■-2U	OFL-3.7-2	17				
Three-phase 460 V	1/2	FRNF50C1■-4U	OFL-0.4-4A	1.5	150% for 1min. 200 % for 0.5 sec	Three-phase 380 to 480 V 50/60 Hz	0.75 to 15	400
	1	FRN001C1■-4U	OFL-1.5-4A	3.7				
	2	FRN002C1■-4U	OFL-3.7-4A	9				
	3	FRN003C1■-4U						
	5	FRN005C1■-4U						

Note 1: The OFL-***-4A models have no restrictions on carrier frequency.

Note 2: A box (■) in the above table replaces S or E depending on enclosure.

[5] Ferrite ring reactors for reducing radio noise (ACL)

An ACL is used to reduce radio frequency noise emitted by the inverter.

An ACL suppresses the outflow of high frequency harmonics caused by switching operation for the power supply lines inside the inverter. Pass the power supply lines together through the ACL.

If wiring length between the inverter and motor is less than 66 ft (20 m), insert an ACL to the power supply lines; if it is more than 66 ft (20 m), insert it to the power output lines of the inverter.

Wire size is determined depending upon the ACL size (I.D.) and installation requirements.

[Unit : inch (mm)]

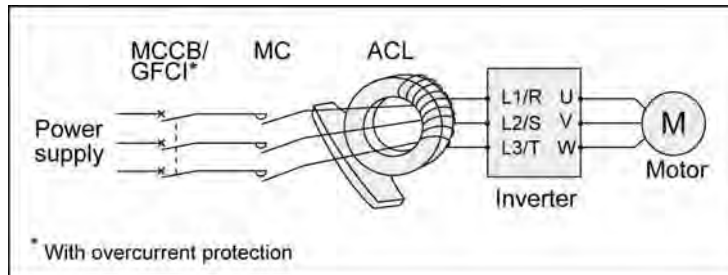
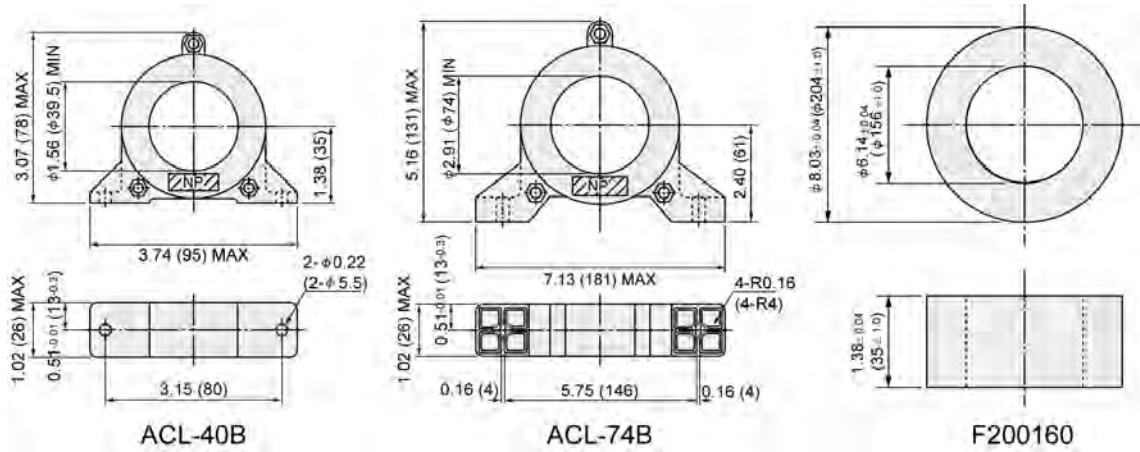

Figure 6.12 Dimensions of Ferrite Ring for Reducing Radio Noise (ACL) and Connection Example

Table 6.13 Ferrite Ring for Reducing Radio Noise (ACL)

Ferrite ring type	Installation requirements		Wire size [inch ² (mm ²)]
	Q'ty	Number of turns	
ACL-40B	1	4	0.003 (2.0)
			0.005 (3.5)
			0.009 (5.5)
	2	2	0.013 (8)
ACL-74B	1	4	0.022 (14)
			0.013 (8)
			0.022 (14)
	2	2	0.034 (22)
			0.059 (38)
			0.094 (60)
	4	1	0.156 (100)
			0.234 (150)
0.313 (200)			
0.391 (250)			
			0.508 (325)

The selected wires are for use with 3-phase input/output lines (3 wires).

6.4.2 Options for operation and communications

[1] External potentiometer for frequency setting

An external potentiometer may be used to set the drive frequency. Connect the potentiometer to control signal terminals [11] to [13] of the inverter as shown in Figure 6.14.

Model: RJ-13 (BA-2 B-characteristics, 1 kΩ)

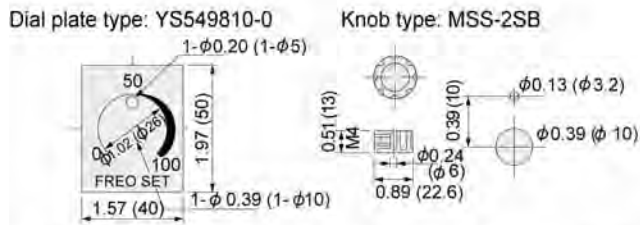
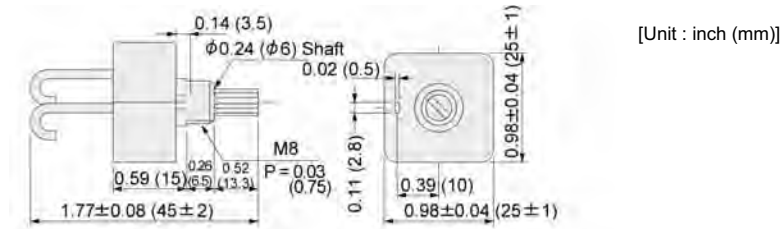

Note: The dial plate and knob must be ordered as separated items.
Available from Fuji Electric Technica Co., Ltd.

Model: WAR3W (3W B-characteristics, 1 kΩ)

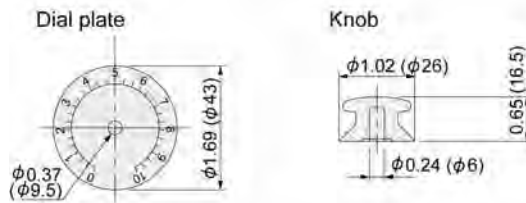

Note: The dial plate and knob are supplied together with the external potentiometer WAR3W.
Available from Fuji Electric Technica Co., Ltd.

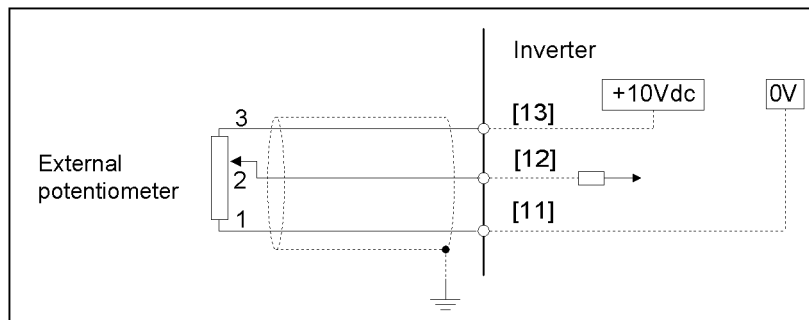

Figure 6.14 External Potentiometer Dimensions and Connection Example

[2] RS-485 communications card "OPC-C1-RS"

The RS-485 communications card is designed exclusively for use with the FRENIC-Mini series of inverter and enables data to be sent to or received from other equipment.

The RS-485 communications facility also enables remote operation of the inverters using the remote keypad and host controllers such as Windows-based personal computers and PLCs (Programmable Logic Controllers), as follows:

- Operating the inverters: setting the frequency, forward/reverse running, stopping, coast-to-stop and resetting, etc.
- Monitoring the operation status of the inverter: output frequency, output current and alarm information, etc.
- Setting function code data.

Table 6.15 Transmission Specifications

Item	Specifications		
Communication protocol	SX protocol (for exclusive use with the support loader software)	Modbus RTU (Conforming to Modicon's Modbus RTU)	Fuji general-purpose inverter protocol
Electrical specifications	EIA RS-485		
Number of units connected	Host: 1 unit, Inverter: 31 units		
Transmission speed	19200, 9600, 4800 and 2400 bps		
Synchronization system	Synchronous start-stop		
Transmission method	Half-duplex		



[3] Remote keypad "TP-E1"

The keypad permits remote control of FRENIC-Mini, and function setting and display (with copy function).



[4] Extension cable for remote operation

The extension cable connects the inverter with the remote keypad to enable remote operation of the inverter. The cable is a straight-wired type with RJ-45 jacks and its length is selectable from 16.4, 9.8 and 3.3 ft (5, 3 and 1 m).



Type	Length [ft (m)]
CB-5S	16.4 (5)
CB-3S	9.8 (3)
CB-1S	3.3 (1)

[Unit : inch (mm)]

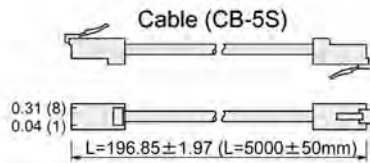

[5] Copy adapter "CPAD-C1A"

The copy adapter can be easily connected to an inverter, and is used to copy data to multiple inverters.



[6] Inverter support loader software

FRENIC Loader is support software which enables the inverter to be operated via the RS-485 communications facility. The main functions include the following:

- Easy editing of function code data
- Monitoring the operation statuses of the inverter such as I/O monitor and multi-monitor
- Operation of inverters on a PC screen (Windows-based only)

 Refer to Chapter 5 "RUNNING THROUGH RS-485 COMMUNICATION (OPTION)" for details.

6.4.3 Extended installation kit options

[1] Mounting adapters

FRENIC-Mini series of inverters can be installed in the control board of your system using mounting adapters which utilize the mounting holes used for conventional inverters (FVR-E11S series of 1 HP or below or 5 HP. The FVR-E11S-2/4 (2 HP/3 HP) and FVR-E11S-7 (1 HP/2 HP) models may be replaced with the FRENIC-Mini series inverters without the use of adapters.

Table 6.16 Mounting Adapters

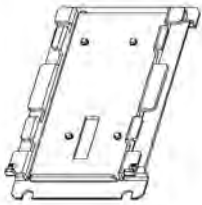
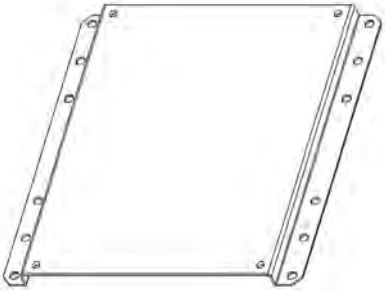
Option model	Applicable inverter model	
	FRENIC-Mini	FVR-E11S
MA-C1-0.75 	FRNF12C1S-2U**	FVRF12E11S-2U
	FRNF25C1S-2U**	FVRF25E11S-2U
	FRNF50C1S-2U**	FVRF50E11S-2U
	FRN001C1S-2U**	FVR001E11S-2U
	FRNF12C1S-7U	FVRF12E11S-7U
	FRNF25C1S-7U	FVRF25E11S-7U
	FRNF50C1S-7U	FVRF50E11S-7U
	FRN001C1S-7U	
	FRNF12C1E-2U	FVRF12E11S-2U
	FRNF25C1E-2U	FVRF25E11S-2U
	FRNF50C1E-2U	FVRF50E11S-2U
	FRN001C1E-2U	FVR001E11S-2U
	FRNF12C1E-7U	FVRF12E11S-7U
	FRNF25C1E-7U	FVRF25E11S-7U
	FRNF50C1E-7U	FVRF50E11S-7U
MA-C1-3.7 	FRN005C1S-2U**	FVR005E11S-2U
	FRN005C1S-4U**	FVR005E11S-4U
	FRN003C1S-7U	FVR003E11S-7U

Note 1: Asterisks (**) in the model names replace numbers which denote the following:
 21: braking resistor built-in type; No number: standard type
 The built-in braking resistor models are available for inverters of 2 HP or higher.

[2] Rail mounting bases

A rail mounting base allows any of the FRENIC-Mini series of inverter to be mounted on a DIN rail (1.38 in (35 mm wide)).

Table 6.17 Rail Mounting Base

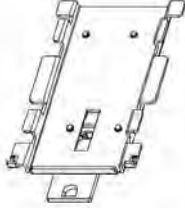
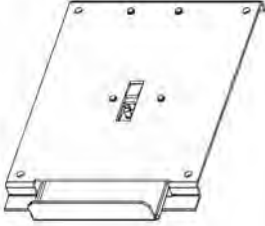
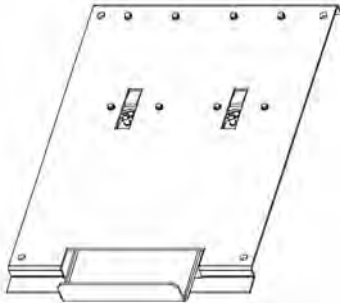
Option model	Applicable inverter type
RMA-C1-0.75 	FRNF12C1S-2U** FRNF25C1S-2U** FRNF50C1S-2U** FRN001C1S-2U**
	FRNF12C1S-7U FRNF25C1S-7U FRNF50C1S-7U FRN001C1S-7U
	FRNF12C1E-2U FRNF25C1E-2U FRNF50C1E-2U FRN001C1E-2U
	FRNF12C1E-7U FRNF25C1E-7U FRNF50C1E-7U
RMA-C1-2.2 	FRN002C1S-2U** FRN003C1S-2U**
	FRNF50C1S-4U** FRN001C1S-4U** FRN002C1S-4U** FRN003C1S-4U**
	FRN002C1S-7U
	FRNF50C1E-4U FRN001C1E-4U
	FRN001C1E-7U
RMA-C1-3.7 	FRN005C1S-2U**
	FRN005C1S-4U**
	FRN003C1S-7U
	FRN002C1E-2U FRN003C1E-2U FRN005C1E-2U
	FRN002C1E-4U FRN003C1E-4U FRN005C1E-4U FRN005C1E-4U
	FRN002C1E-7U FRN003C1E-7U

Note 1: Asterisks (**) in the model names replace numbers which denote the following:
 21: braking resistor built-in type; No number: standard type
 The built-in braking resistor models are available for inverters of 2 HP or higher.

[3] NEMA1 kit

NEMA1 kit, when fitted to the FRENIC-Mini series, protects the inverter body with the structure that conforms to the NEMA1 standard (approved as UL TYPE1).

Table 6.18 NEMA1 Kit

Power supply voltage	Applicable Inverter type	Option type	MODEL
Three-phase 230 V	FRNF12C1S-2U**	NEMA1-0.2C1-2	A
	FRNF25C1S-2U**		
	FRNF50C1S-2U**		
	FRN001C1S-2U**	NEMA1-0.75C1-2	B
	FRN002C1S-2U**	NEMA1-2.2C1-2	
FRN003C1S-2U**	NEMA1-3.7C1-2	C	
Three-phase 460 V	FRNF50C1S-4U**	NEMA1-0.4C1-4	A
	FRN001C1S-4U**	NEMA1-0.75C1-4	B
	FRN002C1S-4U**	NEMA1-2.2C1-2	
	FRN003C1S-4U**	NEMA1-3.7C1-2	C
Single-phase 230 V	FRNF12C1S-7U	NEMA1-0.2C1-2	A
	FRNF25C1S-7U		
	FRNF50C1S-7U	NEMA1-0.4C1-2	B
	FRN001C1S-7U	NEMA1-0.75C1-7	
	FRN002C1S-7U	NEMA1-1.5C1-7	
FRN003C1S-7U	NEMA1-3.7C1-2	C	

Note: For the inverter type FRN___C1S-U**, the symbols ** are replaced with any of the following numeral codes:

21 (Braking resistor built-in type). None (Standard type)

The braking resistor built-in type is limited to the inverters for 2 HP or larger.

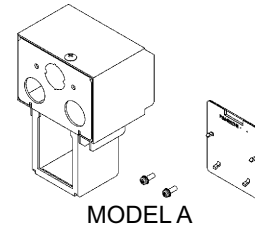

MODEL A

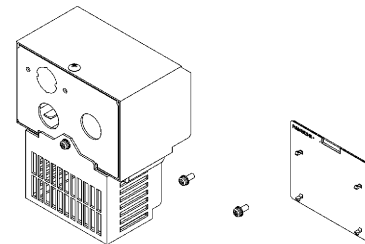

MODEL B

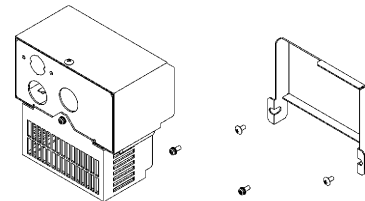

MODEL C

6.4.4 Meter options

[1] Frequency meters

Connect a frequency meter to analog signal output terminals [FMA] (+) and [11] (-) of the inverter to measure the frequency component selected by function code F31. Figure 6.15 shows the dimensions of the frequency meter and a connection example.

Model: TRM-45 (10 VDC, 1 mA)

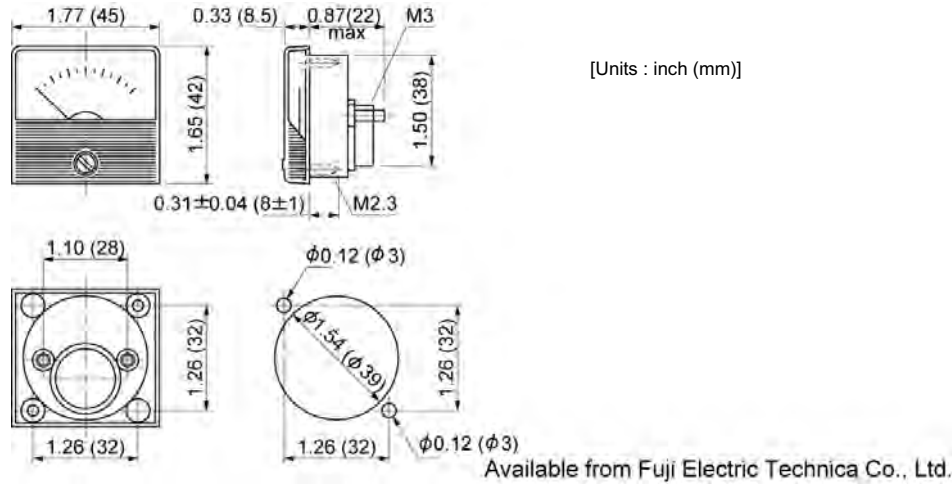

Model: FM-60 (10 VDC, 1 mA)

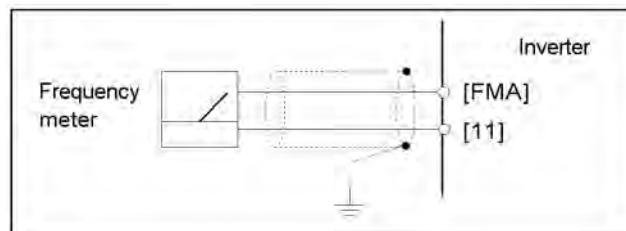
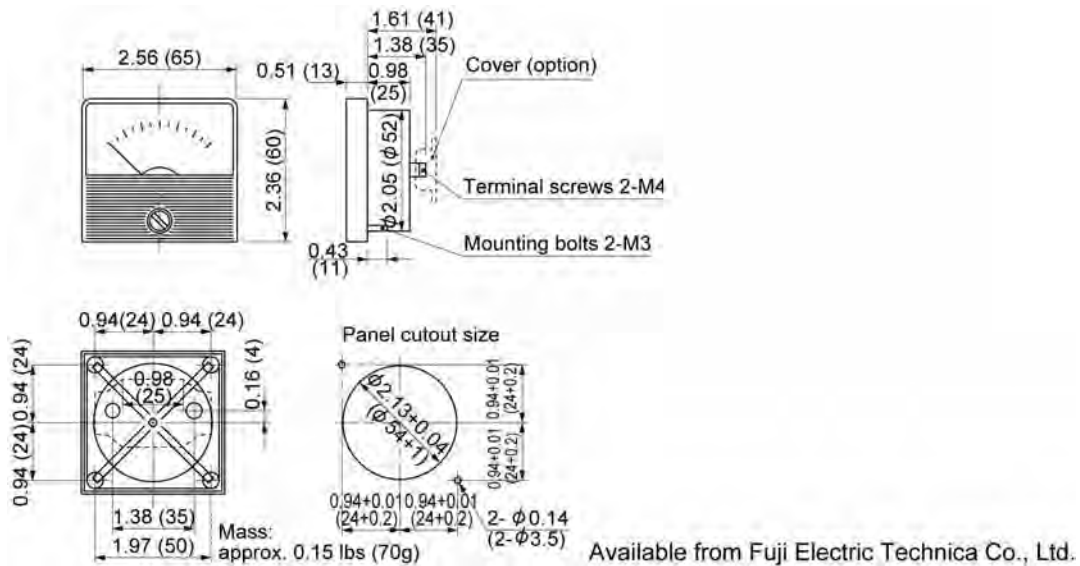

Figure 6.15 Frequency Meter Dimensions and Connection Example

Part 4 Selecting Optimal Inverter Model



Chapter 7 SELECTING OPTIMAL MOTOR AND INVERTER CAPACITIES

Chapter 7

SELECTING OPTIMAL MOTOR AND INVERTER CAPACITIES

This chapter provides you with information about the inverter output torque characteristics, selection procedure, and equations for calculating capacities to help you select optimal motor and inverter models. It also helps you select braking resistors.

Contents

7.1	Selecting Motors and Inverters	7-1
7.1.1	Motor output torque characteristics.....	7-1
7.1.2	Selection procedure.....	7-4
7.1.3	Equations for selections	7-7
7.1.3.1	Load torque during constant speed running	7-7
[1]	General equation	7-7
[2]	Obtaining the required force F	7-7
7.1.3.2	Acceleration and deceleration time calculation.....	7-8
[1]	Calculation of moment of inertia.....	7-8
[2]	Calculation of the acceleration time.....	7-10
[3]	Calculation of the deceleration time.....	7-10
7.1.3.3	Heat energy calculation of braking resistor.....	7-11
[1]	Calculation of regenerative energy.....	7-11
7.1.3.4	Calculating the RMS rating of the motor	7-12
7.2	Selecting a Braking Resistor	7-13
7.2.1	Selection procedure.....	7-13
7.2.2	Notes on selection	7-13

7.1 Selecting Motors and Inverters

When selecting a general-purpose inverter, first select a motor and then inverter as follows:

- (1) Key point for selecting a motor: Determine what kind of load machine is to be used, calculate its moment of inertia, and then select the appropriate motor capacity
- (2) Key point for selecting an inverter: Taking into account the operation requirements (e.g., acceleration time, deceleration time, and frequency in operation) of the load machine to be driven by the motor selected in (1) above, calculate the acceleration/deceleration/braking torque.

This section describes the selection procedure for (1) and (2) above. First, it explains the output torque obtained by using the motor driven by the inverter (FRENIC-Mini).

7.1.1 Motor output torque characteristics

Figures 7.1 and 7.2 graph the output torque characteristics of motors at the rated output frequency individually for 50 Hz and 60 Hz base. The horizontal and vertical axes show the output frequency and output torque (%), respectively. Curves (a) through (f) depend on the running conditions.

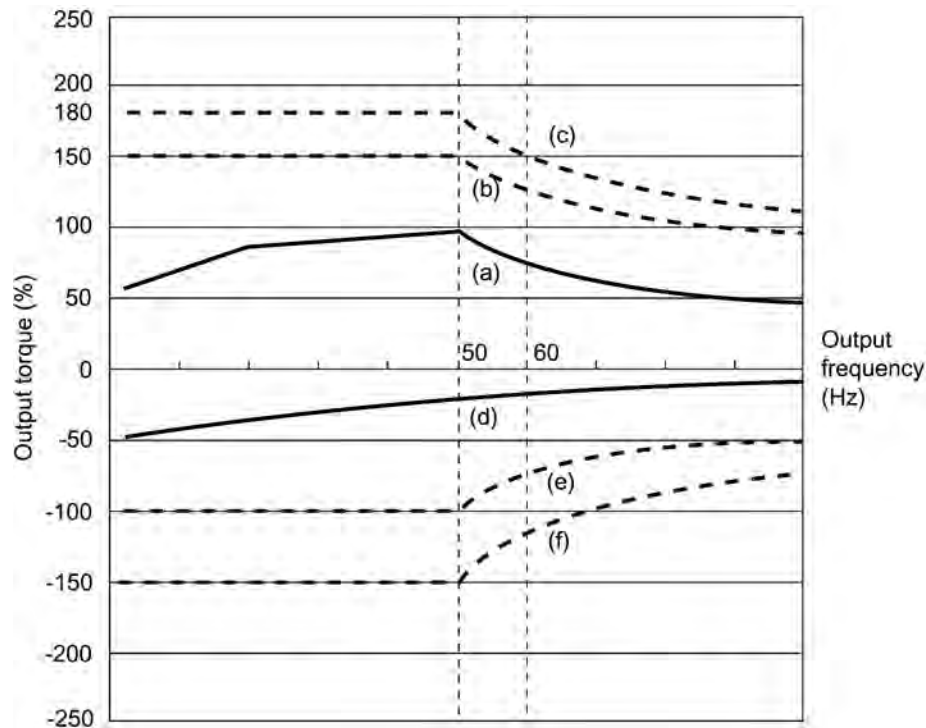

Figure 7.1 Output Torque Characteristics (Base frequency: 50 Hz)

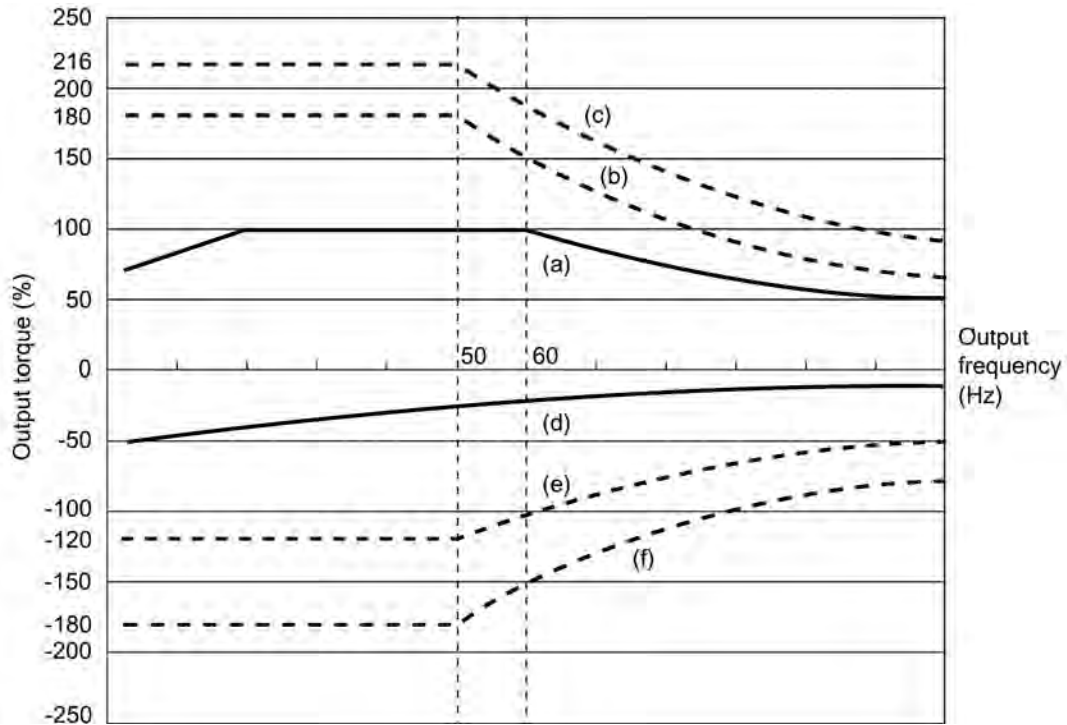

Figure 7.2 Output Torque Characteristics (Base frequency: 60 Hz)

(1) Continuous allowable driving torque (Curve (a) in Figures 7.1 and 7.2)

Curve (a) shows the torque characteristic that can be obtained in the range of the inverter continuous rated current, where the motor cooling characteristic is taken into consideration. When the motor runs at the base frequency of 60 Hz, 100 % output torque can be obtained; at 50 Hz, the output torque is somewhat lower than that in commercial power, and it further lowers at lower frequencies. The reduction of the output torque at 50 Hz is due to increased loss by inverter driving, and that at lower frequencies is mainly due to heat generation caused by the decreased ventilation performance of the motor cooling fan.

(2) Maximum driving torque in a short time (Curves (b) and (c) in Figures 7.1 and 7.2)

Curve (b) shows the torque characteristic that can be obtained in the range of the inverter rated current in a short time (the output torque is 150% for one minute) when torque-vector control is enabled. At that time, the motor cooling characteristics have little effect on the output torque.

Curve (c) shows an example of the torque characteristic when one class higher capacity inverter is used to increase the short-time maximum torque. In this case, the short-time torque is 20 to 30% greater than that when the standard capacity inverter is used.

(3) Starting torque (around the output frequency 0 Hz in Figures 7.1 and 7.2)

The maximum torque in a short time applies to the starting torque as it is.

(4) Braking torque (Curves (d), (e), and (f) in Figures 7.1 and 7.2)

In braking the motor, kinetic energy is converted to electrical energy and regenerated to the DC link bus capacitor (reservoir capacitor) of the inverter. Discharging this electrical energy to the braking resistor produces a large braking torque as shown in curve (e). If no braking resistor is provided, however, only the motor and inverter losses consume the regenerated braking energy so that the torque becomes smaller as shown in curve (d).

Models of 2 HP to 5 HP, 3-phase 230/460 V are each available in a braking resistor built-in type in which the braking torque equivalent to that of the optional braking resistor can be obtained without an optional resistor.

 For more information, refer to Chapter 8, Section 8.2.2 "Braking resistor built-in type."

When an optional braking resistor is used, the braking torque is allowable only for a short time. Its time ratings are mainly determined by the braking resistor ratings. This manual and associated catalogs list the allowable values (HP) obtained from the average discharging loss and allowable values (kW) obtained from the discharging capability that can be discharged at one time.

Note that the torque % value varies according to the inverter capacity.

Selecting an optimal braking unit enables a braking torque value to be selected comparatively freely in the range below the short-time maximum torque in the driving mode, as shown in curve (f).

 For braking-related values when the inverter and braking resistor are normally combined, refer to Chapter 6, Section 6.4.1 [1] "Braking resistors."

7.1.2 Selection procedure

Figure 7.3 shows the general selection procedure for optimal inverters. Items numbered (1) through (5) are described on the following pages.

You may easily select inverter capacity if there are no restrictions on acceleration and deceleration times. If "there are any restrictions on acceleration or deceleration time" or "acceleration and deceleration are frequent," then the selection procedure is more complex.

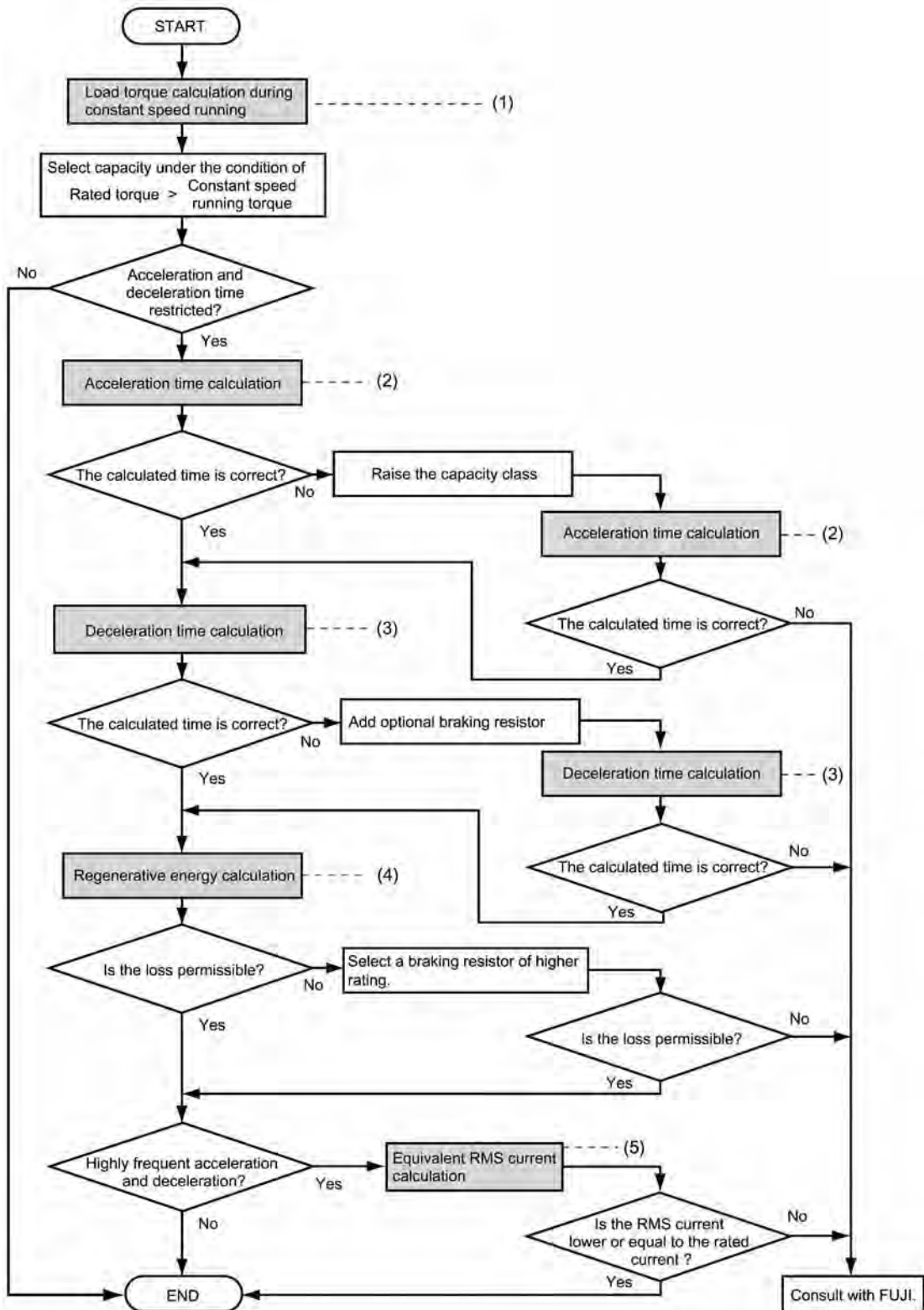

Figure 7.3 Selection Procedure

- (1) Calculating the load torque during constant speed running (For detailed calculation, refer to Section 7.1.3.1)

It is essential to calculate the load torque during constant speed running for all loads.

First calculate the load torque of the motor during constant speed running and then select a tentative capacity so that the continuous rated torque of the motor during constant speed running becomes higher than the load torque. To perform capacity selection efficiently, it is necessary to match the rated speeds (base speeds) of the motor and load. To do this, select an appropriate reduction-gear (mechanical transmission) ratio and the number of motor poles.

If the acceleration or deceleration time is not restricted, the tentative capacity can apply as a defined capacity.

- (2) Calculating the acceleration time (For detailed calculation, refer to Section 7.1.3.2)

When there are some specified requirements for the acceleration time, calculate it according to the following procedure:

- 1) Calculate the moment of inertia for the load and motor
Calculate the moment of inertia for the load, referring to Section 7.1.3.2, "Acceleration and deceleration time calculation." For the motor, refer to the related motor catalogs.
- 2) Calculate the minimum acceleration torque (See Figure 7.4)
The acceleration torque is the difference between the motor short-time output torque (base frequency: 60 Hz) explained in Section 7.1.1 (2), "Maximum driving torque in a short time" and the load torque (τ_L / η_G) during constant speed running calculated in the above (1). Calculate the minimum acceleration torque for the whole range of speed.
- 3) Calculate the acceleration time
Assign the value calculated above to the equation (7.10) in Section 7.1.3.2, "Acceleration and deceleration time calculation" to calculate the acceleration time. If the calculated acceleration time is longer than the expected time, select the inverter and motor having one class larger capacity and calculate it again.

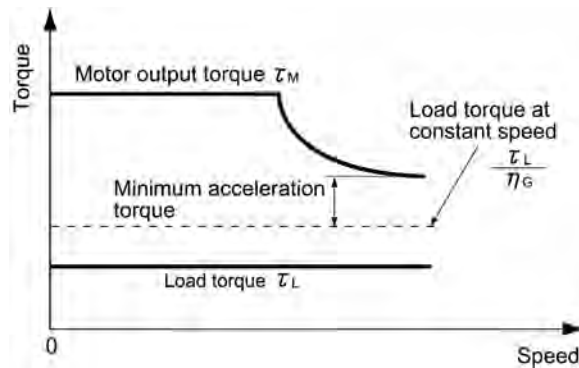

Figure 7.4 Example Study of Minimum Acceleration Torque

(3) Deceleration time (For detailed calculation, refer to Section 7.1.3.2)

To calculate the deceleration time, check the motor deceleration torque characteristics for the whole range of speed in the same way as for the acceleration time.

- 1) Calculate the moment of inertia for the load and motor
Same as for the acceleration time.
- 2) Calculate the minimum deceleration torque (See Figures 7.5 and 7.6.)
Same as for the acceleration time.
- 3) Calculate the deceleration time
Assign the value calculated above to the equation (7.11) to calculate the deceleration time in the same way as for the acceleration time. If the calculated deceleration time is longer than the requested time, select the inverter and motor having one class larger capacity and calculate it again.

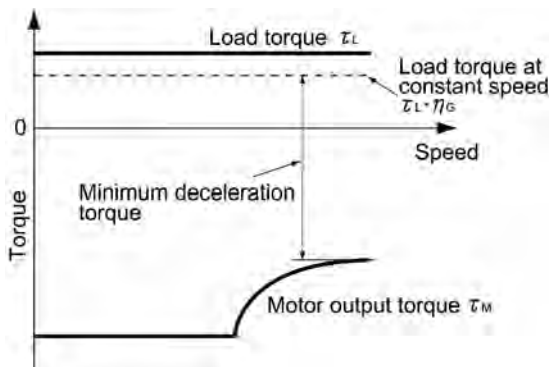

Figure 7.5 Example Study of Minimum Deceleration Torque (1)

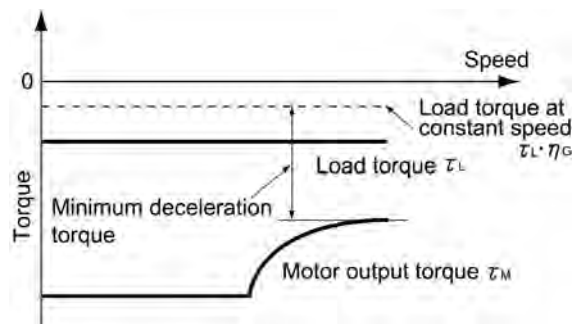

Figure 7.6 Example Study of Minimum Deceleration Torque (2)

(4) Braking resistor rating (For detailed calculation, refer to Section 7.1.3.3)

Braking resistor rating is classified into two types according to the braking periodic duty cycle.

- 1) When the periodic duty cycle is shorter than 100 sec:
Calculate the average loss to determine rated values.
- 2) When the periodic duty cycle is 100 sec or longer:
The allowable braking energy depends on the maximum regenerative braking power. The allowable values are listed in Chapter 6, Section 6.4.1 [1] "Braking resistors."

(5) Motor RMS current (For detailed calculation, refer to Section 7.1.3.4)

In metal processing machine and materials handling machines requiring positioning control, highly frequent running for a short time is repeated. In this case, calculate the maximum equivalent RMS current value (effective value of current) not to exceed the allowable value (rated current) for the motor.

7.1.3 Equations for selections

7.1.3.1 Load torque during constant speed running

[1] General equation

The frictional force acting on a horizontally moved load must be calculated. Calculation for driving a load along a straight line with the motor is shown below.

Where the force to move a load linearly at constant speed v (m/s) is F (N) and the motor speed for driving this is N_M (r/min), the required motor output torque τ_M (N·m) is as follows:

$$\tau_M = 8.8507 \times \frac{60 \cdot v}{2 \pi \cdot N_M} \cdot \frac{F}{\eta_G} \quad (\text{N} \cdot \text{m}) \quad (7.1)$$

where, η_G is Reduction-gear efficiency.

When the inverter brakes the motor, efficiency works inversely, so the required motor torque should be calculated as follows:

$$\tau_M = 8.8507 \times \frac{60 \cdot v}{2 \pi \cdot N_M} \cdot F \cdot \eta_G \quad (\text{N} \cdot \text{m}) \quad (7.2)$$

$(60 \cdot v) / (2 \pi \cdot N_M)$ in the above equation is an equivalent turning radius corresponding to speed v around the motor shaft.

The value F (N) in the above equations depends on the load type.

[2] Obtaining the required force F

Moving a load horizontally

A simplified mechanical configuration is assumed as shown in Figure 7.7. If the mass of the carrier table is W_0 kg, the load is W kg, and the friction coefficient of the ball screw is μ , then the friction force F (N) is expressed as follows, which is equal to a required force for driving the load:

$$F = (W_0 + W) \cdot g \cdot \mu \quad (\text{N}) \quad (7.3)$$

where, g is the gravity acceleration ($\approx 9.8 \text{ m/s}^2$).

Then, the required output torque around the motor shaft is expressed as follows:

$$\tau_M = \frac{60 \cdot v}{2 \pi \cdot N_M} \cdot \frac{(W_0 + W) \cdot g \cdot \mu}{\eta_G} \quad (\text{N} \cdot \text{m}) \quad (7.4)$$

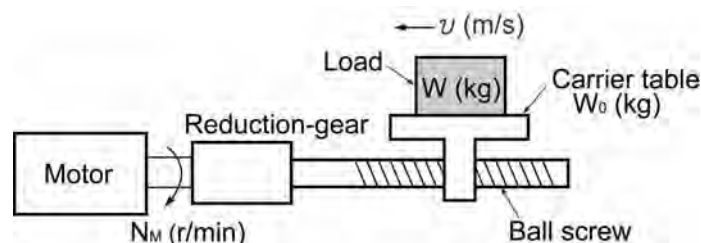

Figure 7.7 Moving a Load Horizontally

7.1.3.2 Acceleration and deceleration time calculation

When an object whose moment of inertia is J ($\text{kg}\cdot\text{m}^2$) rotates at the speed N (r/min), it has the following kinetic energy:

$$E = \frac{J}{2} \cdot \left(\frac{2\pi \cdot N}{60}\right)^2 \quad (\text{J}) \quad (7.5)$$

To accelerate the above rotational object, the kinetic energy will be increased; to decelerate the object, the kinetic energy must be discharged. The torque required for acceleration and deceleration can be expressed as follows:

$$\tau = J \cdot \frac{2\pi}{60} \left(\frac{dN}{dt}\right) \quad (\text{N}\cdot\text{m}) \quad (7.6)$$

This way, the mechanical moment of inertia is an important element in the acceleration and deceleration. First, calculation method of moment of inertia is described, then those for acceleration and deceleration time are explained.

[1] Calculation of moment of inertia

For an object that rotates around the rotation axis, virtually divide the object into small segments and square the distance from the rotation axis to each segment. Then, sum the squares of the distances and the masses of the segments to calculate the moment of inertia.

$$J = \sum (W_i \cdot r_i^2) \quad (\text{kg}\cdot\text{m}^2) \quad (7.7)$$

The following describes equations to calculate moment of inertia having different shaped loads or load systems.

(1) Hollow cylinder and solid cylinder

The common shape of a rotating body is hollow cylinder. The moment of inertia around the hollow cylinder center axis can be calculated as follows, where the outer and inner diameters are D_1 and D_2 (m) and total mass is W (kg) in Figure 7.8.

$$J = \frac{W \cdot (D_1^2 + D_2^2)}{8} \quad (\text{kg}\cdot\text{m}^2) \quad (7.8)$$

For a similar shape, a solid cylinder, calculate the moment of inertia as D_2 is 0.

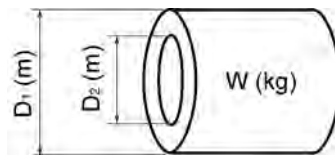
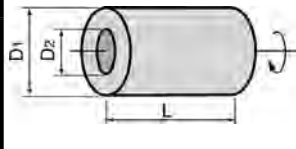
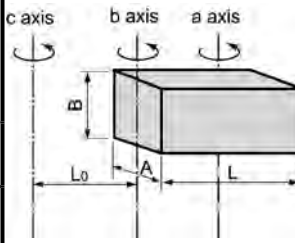
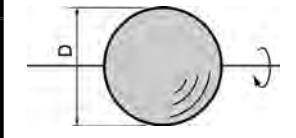
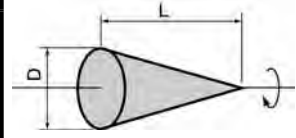
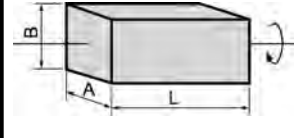
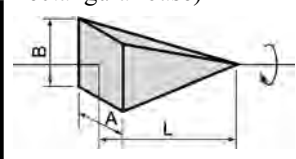
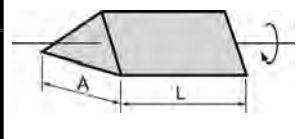
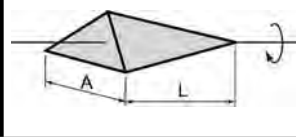
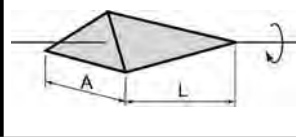

Figure 7.8 Hollow Cylinder

(2) For a general rotating body

Table 7.1 lists the calculation equations of moment of inertia of various rotating bodies including the above cylindrical rotating body.

Table 7.1 Moment of Inertia of Various Rotating Bodies

Shape	Mass: W (kg) Moment of inertia: J (kg·m ²)	Shape	Mass: W (kg) Moment of inertia: J (kg·m ²)
	$W = \frac{\pi}{4} \cdot (D_1^2 - D_2^2) \cdot L \cdot \rho$ $J = \frac{1}{8} \cdot W \cdot (D_1^2 + D_2^2)$		$W = A \cdot B \cdot L \cdot \rho$ $J_a = \frac{1}{12} \cdot W \cdot (L^2 + A^2)$ $J_b = \frac{1}{12} \cdot W \cdot (L^2 + \frac{1}{4} \cdot A^2)$ $J_c \approx W \cdot (L_0^2 + L_0 \cdot L + \frac{1}{3} \cdot L^2)$
	$W = \frac{\pi}{6} \cdot D^3 \cdot \rho$ $J = \frac{1}{10} \cdot W \cdot D^2$		$W = \frac{\pi}{4} \cdot D^2 \cdot L \cdot \rho$ $J_a = \frac{1}{12} \cdot W \cdot (L^2 + \frac{3}{4} \cdot D^2)$ $J_b = \frac{1}{3} \cdot W \cdot (L^2 + \frac{3}{16} \cdot D^2)$ $J_c \approx W \cdot (L_0^2 + L_0 \cdot L + \frac{1}{3} \cdot L^2)$
	$W = A \cdot B \cdot L \cdot \rho$ $J = \frac{1}{12} \cdot W \cdot (A^2 + B^2)$		$W = \frac{1}{3} \cdot A \cdot B \cdot L \cdot \rho$ $J_b = \frac{1}{10} \cdot W \cdot (L^2 + \frac{1}{4} \cdot A^2)$ $J_c \approx W \cdot (L_0^2 + \frac{3}{2} \cdot L_0 \cdot L + \frac{3}{5} \cdot L^2)$
	$W = \frac{\sqrt{3}}{4} \cdot A^2 \cdot L \cdot \rho$ $J = \frac{1}{3} \cdot W \cdot A^2$		$W = \frac{\pi}{12} \cdot D^2 \cdot L \cdot \rho$ $J_b = \frac{1}{10} \cdot W \cdot (L^2 + \frac{3}{8} \cdot D^2)$ $J_c \approx W \cdot (L_0^2 + \frac{3}{2} \cdot L_0 \cdot L + \frac{3}{5} \cdot L^2)$
	$W = \frac{\sqrt{3}}{12} \cdot A^2 \cdot L \cdot \rho$ $J = \frac{1}{5} \cdot W \cdot A^2$	<p>Main metal density (at 20°C (68°F)) ρ(kg/m³) Iron: 7860, Copper: 8940, Aluminum: 2700</p>	

(3) For a load running horizontally

Assume a carrier table driven by a motor as shown in Figure 7.7. If the table speed is v (m/s) when the motor speed is N_M (r/min), then an equivalent distance from the rotation axis is equal to $60 \cdot v / (2\pi \cdot N_M)$ m. The moment of inertia of the table and load to the rotation axis is calculated as follows:

$$J = \left(\frac{60 \cdot v}{2\pi \cdot N_M} \right)^2 \cdot (W_0 + W) \quad (\text{kg} \cdot \text{m}^2) \quad (7.9)$$

[2] Calculation of the acceleration time

Figure 7.9 shows a general load model. Assume that a motor drives a load via a reduction-gear with efficiency η_G . The time required to accelerate this load to a speed of N_M (r/min) is calculated with the following equation:

$$t_{\text{ACC}} = \frac{J_1 + J_2/\eta_G}{\tau_M - \tau_L/\eta_G} \cdot \frac{2\pi \cdot (N_M - 0)}{60} \quad (\text{s}) \quad (7.10)$$

where,

J_1 : Motor shaft moment of inertia ($\text{kg} \cdot \text{m}^2$)

J_2 : Load shaft moment of inertia converted to motor shaft ($\text{kg} \cdot \text{m}^2$)

τ_M : Minimum motor output torque in driving motor ($\text{N} \cdot \text{m}$)

τ_L : Maximum load torque converted to motor shaft ($\text{N} \cdot \text{m}$)

η_G : Reduction-gear efficiency.

As clarified in the above equation, the equivalent moment of inertia becomes $(J_1 + J_2/\eta_G)$ by considering the reduction-gear efficiency.

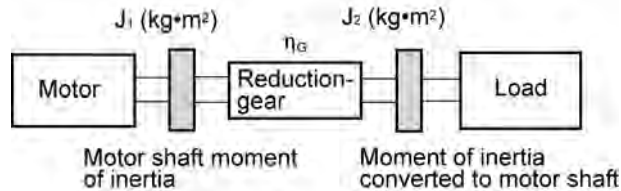

Figure 7.9 Load Model Including Reduction-gear

[3] Calculation of the deceleration time

In a load system shown in Figure 7.9, the time needed to stop the motor rotating at a speed of N_M (r/min) is calculated with the following equation:

$$t_{\text{DEC}} = \frac{J_1 + J_2 \cdot \eta_G}{\tau_M - \tau_L \cdot \eta_G} \cdot \frac{2\pi \cdot (0 - N_M)}{60} \quad (\text{s}) \quad (7.11)$$

where,

J_1 : Motor shaft moment of inertia ($\text{kg} \cdot \text{m}^2$)

J_2 : Load shaft moment of inertia converted to motor shaft ($\text{kg} \cdot \text{m}^2$)

τ_M : Minimum motor output torque in braking (or decelerating) motor ($\text{N} \cdot \text{m}$)

τ_L : Maximum load torque converted to motor shaft ($\text{N} \cdot \text{m}$)

η_G : Reduction-gear efficiency

In the above equation, generally output torque τ_M is negative and load torque τ_L is positive. So, deceleration time becomes shorter.

7.1.3.3 Heat energy calculation of braking resistor

If the inverter brakes the motor, the kinetic energy of mechanical load is converted to electric energy to be regenerated into the inverter circuit. This regenerative energy is often consumed in so-called braking resistors as heat. The following explains the braking resistor rating.

[1] Calculation of regenerative energy

In the inverter operation, one of the regenerative energy sources is the kinetic energy that is generated at the time an object is moved by an inertial force.

Kinetic energy of a moving object

When an object with moment of inertia J ($\text{kg}\cdot\text{m}^2$) rotates at a speed N_2 (r/min), its kinetic energy is as follows:

$$E = \frac{J}{2} \cdot \left(\frac{2\pi \cdot N_2}{60} \right)^2 \quad (\text{J}) \quad (7.12)$$

$$\approx \frac{1}{182.4} \cdot J \cdot N_2^2 \quad (\text{J}) \quad (7.12)'$$

When this object is decelerated to a speed N_1 (r/min), the output energy is as follows:

$$E = \frac{J}{2} \cdot \left[\left(\frac{2\pi \cdot N_2}{60} \right)^2 - \left(\frac{2\pi \cdot N_1}{60} \right)^2 \right] \quad (\text{J}) \quad (7.13)$$

$$\approx \frac{1}{182.4} \cdot J \cdot (N_2^2 - N_1^2) \quad (\text{J}) \quad (7.13)'$$

The energy regenerated to the inverter as shown in Figure 7.9 is calculated from the reduction-gear efficiency η_G and motor efficiency τ_M as follows:

$$E \approx \frac{1}{182.4} \cdot (J_1 + J_2 \cdot \eta_G) \cdot \eta_M \cdot (N_2^2 - N_1^2) \quad (\text{J}) \quad (7.14)$$

7.1.3.4 Calculating the RMS rating of the motor

In case of the load which is repeatedly and very frequently driven by a motor, the load current fluctuates largely and enters the short-time rating range of the motor repeatedly. Therefore, you have to review the thermal allowable rating of the motor. The heat value is assumed to be approximately proportional to the square of the load current.

If an inverter drives a motor in duty cycles that are much shorter than the thermal time constant of the motor, calculate the "equivalent RMS current" as mentioned below, and select the motor so that this RMS current will not exceed the rated current of the motor.

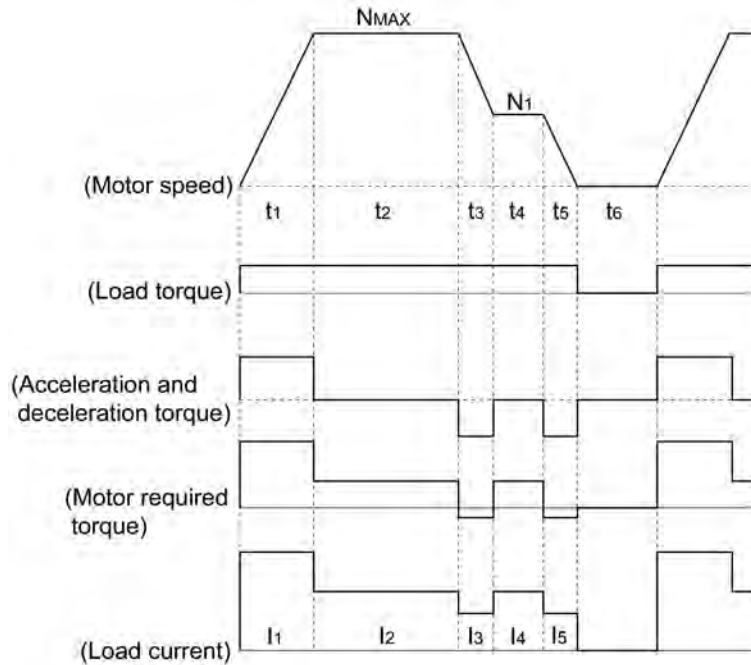

Figure 7.10 Sample of the Repetitive Operation

First, calculate the required torque of each part based on the speed pattern. Then using the torque-current curve of the motor, convert the torque to the load current. The "equivalent RMS current, I_{eq} " can be finally calculated by the following equation:

$$I_{eq} = \sqrt{\frac{I_1^2 \cdot t_1 + I_2^2 \cdot t_2 + I_3^2 \cdot t_3 + I_4^2 \cdot t_4 + I_5^2 \cdot t_5}{t_1 + t_2 + t_3 + t_4 + t_5 + t_6}} \quad (A) \quad (7.15)$$

The torque-current curve for the dedicated motor is not available for actual calculation. Therefore, calculate the load current I from the load torque τ_1 using the following equation (7.16). Then, calculate the equivalent current I_{eq} :

$$I = \sqrt{\left(\frac{\tau_1}{100} \times I_{t100}\right)^2 + I_{m100}^2} \quad (A) \quad (7.16)$$

Where, τ_1 is the load torque (%), I_{t100} is the torque current, and I_{m100} is exciting current.

7.2 Selecting a Braking Resistor

7.2.1 Selection procedure

The following three requirements must be satisfied simultaneously:

- 1) The maximum braking torque should not exceed values listed in Tables 6.7 to 6.9 in Chapter 6, Section 6.4.1 [1] "Braking resistors." To use the maximum braking torque exceeding values in those tables, select the braking resistor having one class larger capacity.
- 2) The discharge energy for a single braking action should not exceed the discharging capability (kW) listed in Tables 6.7 to 6.9 in Chapter 6, Section 6.4.1 [1] "Braking resistors." For detailed calculation, refer to Section 7.1.3.3 "Heat energy calculation of braking resistor."
- 3) The average loss that is calculated by dividing the discharge energy by the cyclic period must not exceed the average loss (kW) listed in Tables 6.7 to 6.9 in Chapter 6, Section 6.4.1 [1] "Braking resistors."

7.2.2 Notes on selection

The braking time T_1 , cyclic period T_0 , and duty cycle %ED are converted under deceleration braking conditions based on the rated torque as shown below. However, you do not need to consider these values when selecting the braking resistor capacity.

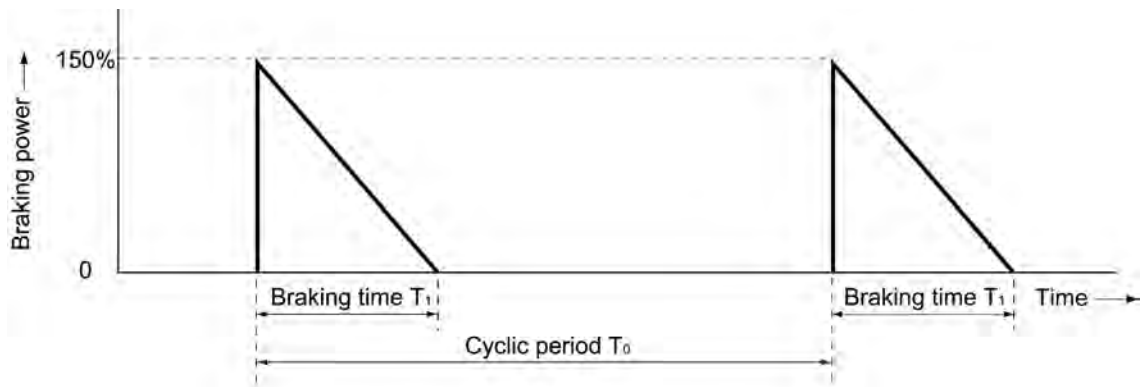

Figure 7.11 Duty Cycle

Part 5 Specifications



Chapter 8 SPECIFICATIONS

Chapter 9 FUNCTION CODES

Chapter 8

SPECIFICATIONS

This chapter describes specifications of the output ratings, control system, and terminal functions for the FRENIC-Mini series of inverters. It also provides descriptions of the operating and storage environment, external dimensions, examples of basic connection diagrams, and details of the protective functions.

Contents

8.1	Standard Models	8-1
8.1.1	Three-phase 230 V	8-1
8.1.2	Three-phase 460 V	8-2
8.1.3	Single-phase 230 V	8-3
8.2	Models Available on Order	8-4
8.2.1	EMC filter built-in type.....	8-4
8.2.1.1	Three-phase 230 V	8-4
8.2.1.2	Three-phase 460 V	8-5
8.2.1.3	Single-phase 230 V	8-6
8.2.2	Braking resistor built-in type.....	8-7
8.2.2.1	Three-phase 230 V	8-7
8.2.2.2	Three-phase 460 V	8-8
8.3	Common Specifications	8-9
8.4	Terminal Specifications.....	8-11
8.4.1	Terminal functions	8-11
8.4.2	Terminal block arrangement.....	8-23
8.4.3	Terminal arrangement diagram and screw specifications.....	8-24
8.4.3.1	Main circuit terminals	8-24
8.4.3.2	Control circuit terminal	8-25
8.5	Operating Environment and Storage Environment	8-26
8.5.1	Operating environment.....	8-26
8.5.2	Storage environment	8-27
8.5.2.1	Temporary storage.....	8-27
8.5.2.2	Long-term storage	8-27
8.6	External Dimensions	8-28
8.6.1	Standard models and models available on order (braking resistor built-in type)	8-28
8.6.2	Models available on order (EMC filter built-in type).....	8-30
8.7	Connection Diagrams.....	8-32
8.7.1	Keypad operation	8-32
8.7.2	Operation by external signal inputs.....	8-33
8.8	Details of Protective Functions	8-34

8.1 Standard Models

In the European version, these models listed in Section 8.1 are available on order.

8.1.1 Three-phase 230 V

Item		Specifications							
Power supply voltage		Three-phase 230 V							
Type (FRN ___ C1S-2U)		F12	F25	F50	001	002	003	005	
Applicable motor rating (HP)		*1 1/8	1/4	1/2	1	2	3	5	
Output Ratings	Rated capacity (kVA)	*2 0.3	0.57	1.1	1.9	3.0	4.1	6.4	
	Rated voltage (V)	*3 Three-phase, 200 V/50 Hz, 200 V, 220 V, 230 V/60 Hz							
	Rated current (A)	*4 0.8 (0.7)	1.5 (1.4)	3.0 (2.5)	5.0 (4.2)	8.0 (7.0)	11.0 (10.0)	17.0 (16.5)	
	Overload capability	150 % of rated output current for 1 min. 200 % of rated output current for 0.5 s							
	Rated frequency (Hz)	50, 60 Hz							
Input Ratings	Phases, voltage, frequency	Three-phase, 200 to 240 V, 50/60 Hz							
	Voltage and frequency variations	Voltage: +10 to -15 % (Interphase voltage unbalance*10: 2 % or less) Frequency: +5 to -5 %							
	Momentary voltage dip capability	*5 When the input voltage is 165 V or more, the inverter may keep running. Even if it drops below 165 V, the inverter may keep running for 15 ms.							
	Rated current (A)	(w/ DCR)	0.57	0.93	1.6	3.0	5.7	8.3	14.0
		(w/o DCR)	1.1	1.8	3.1	5.3	9.5	13.2	22.2
Required power supply capacity (kVA)	*6 *7	0.2	0.3	0.6	1.1	2.0	2.9	4.9	
Braking	Torque (%)	*8 150		100		50	30		
	Torque (%)	*9 -		150					
	DC injection braking	Starting frequency: 0.0 to 60.0 Hz Braking time: 0.0 to 30.0 s Braking level: 0 to 100 % of rated current							
Enclosure (IEC60529)		IP20, UL open type*11							
Cooling method		Natural cooling				Fan cooling			
Weight [lbs (kg)]		1.3 (0.6)	1.3 (0.6)	1.3 (0.6)	1.5 (0.7)	3.7 (1.7)	3.7 (1.7)	5.1 (2.3)	

*1 Fuji 4-pole standard motors

*2 The rated capacity is for 230 V output voltage.

*3 Output voltages cannot exceed the power supply voltage.

*4 Use the inverter at the current given in () or below when the carrier frequency is higher than 4 kHz ($f_{\text{carrier}} = 4$ to 15) or the ambient temperature is 40°C (104°F) or higher.

*5 Tested under the standard load condition (85% load for applicable motor rating).

*6 Calculated under Fuji-specified conditions.

*7 Indicates the value when using a DC reactor (option).

*8 Average braking torque obtained with the AVR control off ($f_{\text{braking}} = 1$). (Varies according to the efficiency of the motor.)

*9 Average braking torque obtained by use of an external braking resistor (standard type available as option).

*10 Interphase voltage unbalance (%) = $\frac{\text{Max.voltage (V)} - \text{Min.voltage (V)}}{3\text{-phase average voltage (V)}} \times 67$ (Refer to IEC 61800-3 (5.2.3))

If this value is 2 to 3 %, use an AC reactor (ACR).

*11 Making FRENIC-Mini conform to category TYPE1 of the UL Standard (or NEMA1) requires an optional NEMA1 kit. Note that the TYPE1-listed FRENIC-Mini should be used in the ambient temperature range from -10 to +40°C (+14 to +104°F).

8.1.2 Three-phase 460 V

Item		Specifications					
Power supply voltage		Three-phase 460 V					
Type (FRN ___ C1S-4U)		F50	001	002	003	005	
Applicable motor rating (HP) *1		1/2	1	2	3	5	
Output Ratings	Rated capacity (kVA) *2	1.1	1.9	2.8	4.1	6.8	
	Rated voltage (V) *3	Three-phase, 380, 400, 415 V/50 Hz, 380, 400, 440, 460 V/60 Hz					
	Rated current (A)	1.5	2.5	3.7	5.5	9.0	
	Overload capability	150 % of rated output current for 1 min. 200 % of rated output current for 0.5 s					
	Rated frequency (Hz)	50, 60 Hz					
	Phases, voltage, frequency	Three-phase, 380 to 480 V, 50/60 Hz					
Input Ratings	Voltage and frequency variations	Voltage : +10 to -15 % (Interphase voltage unbalance*9: 2 % or less) Frequency: +5 to -5 %					
	Momentary voltage dip capability *4	When the input voltage is 300 V or more, the inverter may keep running. Even if it drops below 300 V, the inverter may keep running for 15 ms.					
	Rated current (A) *5	(w/ DCR)	0.85	1.6	3.0	4.4	7.3
		(w/o DCR)	1.7	3.1	5.9	8.2	13.0
	Required power supply capacity (kVA) *6	0.6	1.1	2.0	2.9	4.9	
Braking	Torque (%) *7	100		50	30		
	Torque (%) *8	150					
	DC injection braking	Starting frequency: 0.0 to 60.0 Hz Braking time: 0.0 to 30.0 s Braking level: 0 to 100 % of rated current					
Enclosure (IEC60529)		IP20, UL open type*10					
Cooling method		Natural cooling		Fan cooling			
Weight [lbs (kg)]		2.4 (1.1)	2.7 (1.2)	3.7 (1.7)	3.7 (1.7)	5.1 (2.3)	

*1 Fuji 4-pole standard motors

*2 The rated capacity is for 460 V output voltage.

*3 Output voltages cannot exceed the power supply voltage.

*4 Tested under the standard load condition (85% load for applicable motor rating).

*5 Calculated under Fuji-specified conditions.

*6 Indicates the value when using a DC reactor (option).

*7 Average braking torque obtained with the AVR control off ($F_{\text{DS}} = \square$). (Varies according to the efficiency of the motor.)

*8 Average braking torque obtained by use of an external braking resistor (standard type available as option).

*9 Interphase voltage unbalance (%) = $\frac{\text{Max.voltage (V)} - \text{Min.voltage (V)}}{3\text{-phase average voltage (V)}} \times 67$ (Refer to IEC 61800-3 (5.2.3))

If this value is 2 to 3 %, use an AC reactor (ACR).

*10 Making FRENIC-Mini conform to category TYPE1 of the UL Standard (or NEMA1) requires an optional NEMA1 kit. Note that the TYPE1-listed FRENIC-Mini should be used in the ambient temperature range from -10 to +40°C (+14 to +104°F).

8.1.3 Single-phase 230 V

Item		Specifications						
Power supply voltage		Single-phase 230 V						
Type (FRN __ C1S-7U)		F12	F25	F50	001	002	003	
Applicable motor rating (HP)		*1 1/8	1/4	1/2	1	2	3	
Output Ratings	Rated capacity (kVA)	*2 0.3	0.57	1.1	1.9	3.0	4.1	
	Rated voltage (V)	*3 Three-phase, 200 V/50 Hz, 200 V, 220 V, 230 V/60 Hz						
	Rated current (A)	0.8 (0.7)	1.5 (1.4)	3.0 (2.5)	5.0 (4.2)	8.0 (7.0)	11.0 (10.0)	
	Overload capability	150 % of rated output current for 1 min. 200 % of rated output current for 0.5 s						
	Rated frequency (Hz)	50, 60 Hz						
Input Ratings	Phases, voltage, frequency	Single-phase, 200 to 240 V, 50/60 Hz						
	Voltage and frequency variations	Voltage : +10 to -10 % Frequency: +5 to -5 %						
	Momentary voltage dip capability	*5 When the input voltage is 165 V or more, the inverter may keep running. Even if it drops below 165 V, the inverter may keep running for 15 ms.						
	Rated current (A)	(w/ DCR)	1.1	2.0	3.5	6.4	11.6	17.5
		(w/o DCR)	1.8	3.3	5.4	9.7	16.4	24.8
Required power supply capacity (kVA)	*7	0.3	0.4	0.7	1.3	2.4	3.5	
Braking	Torque (%)	*8 150		100		50 30		
	Torque (%)	*9 -		150				
	DC injection braking	Starting frequency: 0.0 to 60.0 Hz Braking time: 0.0 to 30.0 s Braking level: 0 to 100 % of rated current						
Enclosure (IEC60529)		IP20, UL open type*10						
Cooling method		Natural cooling				Fan cooling		
Weight [lbs (kg)]		1.3 (0.6)	1.3 (0.6)	1.3 (0.6)	1.8 (0.8)	3.5 (1.6)	5.1 (2.3)	

- *1 Fuji 4-pole standard motors
- *2 The rated capacity is for 230 V output voltage.
- *3 Output voltages cannot exceed the power supply voltage.
- *4 Use the inverter at the current given in () or below when the carrier frequency is higher than 4 kHz ($f_{CE} = 4$ to 15) or the ambient temperature is 40°C (104°F) or higher.
- *5 Tested under the standard load condition (85% load for applicable motor rating).
- *6 Calculated under Fuji-specified conditions.
- *7 Indicates the value when using a DC reactor (option).
- *8 Average braking torque obtained with the AVR control off ($f_{CS} = 1$). (Varies according to the efficiency of the motor.)
- *9 Average braking torque obtained by use of an external braking resistor (standard type available as option).
- *10 Making FRENIC-Mini conform to category TYPE1 of the UL Standard (or NEMA1) requires an optional NEMA1 kit. Note that the TYPE1-listed FRENIC-Mini should be used in the ambient temperature range from -10 to +40°C (+14 to +104°F).

8.2 Models Available on Order

8.2.1 EMC filter built-in type

In the European version, the EMC filter built-in type is provided as a standard model. In other versions, it is available on order.

8.2.1.1 Three-phase 230 V

Item		Specifications							
Power supply voltage		Three-phase 230 V							
Type (FRN ___ CIE-2U)		F12	F25	F50	001	002	003	005	
Applicable motor rating (HP)		*1 1/8	1/4	1/2	1	2	3	5	
Output Ratings	Rated capacity (kVA)	*2 0.3	0.57	1.1	1.9	3.0	4.1	6.4	
	Rated voltage (V)	*3 Three-phase, 200 V/50 Hz, 200 V, 220 V, 230 V/60 Hz							
	Rated current (A)	*4 0.8 (0.7)	1.5 (1.4)	3.0 (2.5)	5.0 (4.2)	8.0 (7.0)	11.0 (10.0)	17.0 (16.5)	
	Overload capability	150 % of rated output current for 1 min. 200 % of rated output current for 0.5 s							
	Rated frequency (Hz)	50, 60 Hz							
Input Ratings	Phases, voltage, frequency	Three-phase, 200 to 240 V, 50/60 Hz							
	Voltage and frequency variations	Voltage : +10 to -15 % (Interphase voltage unbalance*10: 2 % or less) Frequency: +5 to -5 %							
	Momentary voltage dip capability	*5 When the input voltage is 165 V or more, the inverter may keep running. Even if it drops below 165 V, the inverter may keep running for 15 ms.							
	Rated current (A)	(w/ DCR)	0.57	0.93	1.6	3.0	5.7	8.3	14.0
		(w/o DCR)	1.1	1.8	3.1	5.3	9.5	13.2	22.2
	Required power supply capacity (kVA)	*7 0.2	0.3	0.6	1.1	2.0	2.9	4.9	
Braking	Torque (%)	*8 150			100	50	30		
	Torque (%)	*9 -			150				
	DC injection braking	Starting frequency: 0.0 to 60.0 Hz Braking time: 0.0 to 30.0 s Braking level: 0 to 100 % of rated current							
Enclosure (IEC60529)		IP20, UL open type*11							
Cooling method		Natural cooling				Fan cooling			
Weight [lbs (kg)]		1.5 (0.7)	1.5 (0.7)	1.5 (0.7)	1.8 (0.8)	5.3 (2.4)	5.3 (2.4)	6.4 (2.9)	

*1 Fuji 4-pole standard motors

*2 The rated capacity is for 230 V output voltage.

*3 Output voltages cannot exceed the power supply voltage.

*4 Use the inverter at the current given in () or below when the carrier frequency is higher than 4 kHz ($f_{\text{carrier}} = 4$ to 15) or the ambient temperature is 40°C (140°F) or higher.

*5 Tested under the standard load condition (85% load for applicable motor rating).

*6 Calculated under Fuji-specified conditions.

*7 Indicates the value when using a DC reactor (option).

*8 Average braking torque obtained with the AVR control off ($f_{\text{braking}} = 0$). (Varies according to the efficiency of the motor.)

*9 Average braking torque obtained by use of an external braking resistor (standard type available as option).

*10 Interphase voltage unbalance (%) = $\frac{\text{Max. voltage (V)} - \text{Min. voltage (V)}}{3\text{-phase average voltage (V)}} \times 67$ (Refer to IEC 61800-3 (5.2.3))

If this value is 2 to 3 %, use an AC reactor (ACR).

*11 Making FRENIC-Mini conform to category TYPE1 of the UL Standard (or NEMA1) requires an optional NEMA1 kit. Note that the TYPE1-listed FRENIC-Mini should be used in the ambient temperature range from -10 to +40°C (+14 to +104°F).

8.2.1.2 Three-phase 460 V

Item		Specifications					
Power supply voltage		Three-phase 460 V					
Type (FRN ___ C1E-4U)		F50	001	002	003	005	
Applicable motor rating (HP) *1		1/8	1	2	3	5	
Output Ratings	Rated capacity (kVA) *2	1.1	1.9	2.8	4.1	6.8	
	Rated voltage (V) *3	Three-phase, 380, 400, 415 V/50 Hz, 380, 400, 440, 460 V/60 Hz					
	Rated current (A)	1.5	2.5	3.7	5.5	9.0	
	Overload capability	150 % of rated output current for 1 min. 200 % of rated output current for 0.5 s					
	Rated frequency (Hz)	50, 60 Hz					
Input Ratings	Phases, voltage, frequency	Three-phase, 380 to 480 V, 50/60 Hz					
	Voltage and frequency variations	Voltage : +10 to -15 % (Interphase voltage unbalance*9; 2 % or less) Frequency: +5 to -5 %					
	Momentary voltage dip capability *4	When the input voltage is 300 V or more, the inverter may keep running. Even if it drops below 300 V, the inverter may keep running for 15 ms.					
	Rated current (A) *5	(w/ DCR)	0.85	1.6	3.0	4.4	7.3
		(w/o DCR)	1.7	3.1	5.9	8.2	13.0
Required power supply capacity (kVA) *6	0.6, 1.1, 2.0, 2.9, 4.9						
Braking	Torque (%) *7	100		50	30		
	Torque (%) *8	150					
	DC injection braking	Starting frequency: 0.0 to 60.0 Hz Braking time: 0.0 to 30.0 s Braking level: 0 to 100 % of rated current					
Enclosure (IEC60529)		IP20, UL open type*10					
Cooling method		Natural cooling		Fan cooling			
Weight [lbs (kg)]		3.3 (1.5)	3.5 (1.6)	5.5 (2.5)	5.5 (2.5)	6.6 (3.0)	

*1 Fuji 4-pole standard motors

*2 The rated capacity is for 460 V output voltage.

*3 Output voltages cannot exceed the power supply voltage.

*4 Tested under the standard load condition (85% load for applicable motor rating).

*5 Calculated under Fuji-specified conditions.

*6 Indicates the value when using a DC reactor (option).

*7 Average braking torque obtained with the AVR control off ($F_{DS} = \square$). (Varies according to the efficiency of the motor.)

*8 Average braking torque obtained by use of an external braking resistor (standard type available as option).

*9 Interphase voltage unbalance (%) = $\frac{\text{Max.voltage (V)} - \text{Min.voltage (V)}}{3\text{-phase average voltage (V)}} \times 67$ (Refer to IEC 61800-3 (5.2.3))

If this value is 2 to 3 %, use an AC reactor (ACR).

*10 Making FRENIC-Mini conform to category TYPE1 of the UL Standard (or NEMA1) requires an optional NEMA1 kit. Note that the TYPE1-listed FRENIC-Mini should be used in the ambient temperature range from -10 to +40°C (+14 to +104°F).

8.2.1.3 Single-phase 230 V

Item		Specifications						
Power supply voltage		Single-phase 230 V						
Type (FRN ___ C1E-7U)		F12	F25	F50	001	002	003	
Applicable motor rating (HP)		*1 1/8	1/4	1/2	1	2	3	
Output Ratings	Rated capacity (kVA)	*2 0.3	0.57	1.1	1.9	3.0	4.1	
	Rated voltage (V)	*3 Three-phase, 200 V/50 Hz, 200 V, 220 V, 230 V/60 Hz						
	Rated current (A)	*4 0.8 (0.7)	1.5 (1.4)	3.0 (2.5)	5.0 (4.2)	8.0 (7.0)	11.0 (10.0)	
	Overload capability	150 % of rated output current for 1 min. 200 % of rated output current for 0.5 s						
	Rated frequency (Hz)	50, 60 Hz						
	Phases, voltage, frequency		Single-phase, 200 to 240 V, 50/60 Hz					
Input Ratings	Voltage and frequency variations		Voltage : +10 to -10 % Frequency: +5 to -5 %					
	Momentary voltage dip capability		*5 When the input voltage is 165 V or more, the inverter may keep running. Even if it drops below 165 V, the inverter may keep running for 15 ms.					
	Rated current (A)	(w/ DCR)	1.1	2.0	3.5	6.4	11.6	17.5
		*6 (w/o DCR)	1.8	3.3	5.4	9.7	16.4	24.8
	Required power supply capacity (kVA)		*7 0.3	0.4	0.7	1.3	2.4	3.5
Braking	Torque (%)		*8 150		100	50	30	
	Torque (%)		*9 -		150			
	DC injection braking		Starting frequency: 0.0 to 60.0 Hz Braking time: 0.0 to 30.0 s Braking level: 0 to 100 % of rated current					
Enclosure (IEC60529)		IP20, UL open type*10						
Cooling method		Natural cooling				Fan cooling		
Weight [lbs (kg)]		1.5 (0.7)	1.5 (0.7)	1.5 (0.7)	2.7 (1.2)	5.3 (2.4)	6.4 (2.9)	

*1 Fuji 4-pole standard motors

*2 The rated capacity is for 230 V output voltage.

*3 Output voltages cannot exceed the power supply voltage.

*4 Use the inverter at the current given in () or below when the carrier frequency is higher than 4 kHz ($f_{\text{carrier}} = 4$ to f_{max}) or the ambient temperature is 40°C (140°F) or higher.

*5 Tested under the standard load condition (85% load for applicable motor rating).

*6 Calculated under Fuji-specified conditions.

*7 Indicates the value when using a DC reactor (option).

*8 Average braking torque obtained with the AVR control off ($f_{\text{AVR}} = \square$). (Varies according to the efficiency of the motor.)

*9 Average braking torque obtained by use of an external braking resistor (standard type available as option).

*10 Making FRENIC-Mini conform to category TYPE1 of the UL Standard (or NEMA1) requires an optional NEMA1 kit. Note that the TYPE1-listed FRENIC-Mini should be used in the ambient temperature range from -10 to +40°C (+14 to +104°F).

8.2.2 Braking resistor built-in type

8.2.2.1 Three-phase 230 V

Item		Specifications			
Power supply voltage		Three-phase 230 V			
Type (FRN ___ CIS-2U21)		002	003	005	
Applicable motor rating (HP) *1		2	3	5	
Output Ratings	Rated capacity (kVA) *2	3.0	4.1	6.4	
	Rated voltage (V) *3	Three-phase, 200 V/50 Hz, 200 V, 220 V, 230 V/60 Hz			
	Rated current (A) *4	8.0 (7.0)	11.0 (10.0)	17.0 (16.5)	
	Overload capability	150 % of rated output current for 1 min. 200 % of rated output current for 0.5 s			
	Rated frequency (Hz)	50, 60 Hz			
Input Ratings	Phases, voltage, frequency		Three-phase, 200 to 240 V, 50/60 Hz		
	Voltage and frequency variations		Voltage : +10 to -15 % (Interphase voltage unbalance*9; 2 % or less) Frequency: +5 to -5 %		
	Momentary voltage dip capability *5		When the input voltage is 165 V or more, the inverter may keep running. Even if it drops below 165 V, the inverter may keep running for 15 ms.		
	Rated current (A) *6	(w/ DCR)	5.7	8.3	14.0
		(w/o DCR)	9.5	13.2	22.2
Required power supply capacity (kVA) *7		2.0	2.9	4.9	
Braking	Torque (%) *8	150	100	100	
	Braking time (s)	18	12	8	
	Duty cycle (%)	3	2	1.5	
	DC injection braking	Starting frequency: 0.0 to 60.0 Hz Braking time: 0.0 to 30.0 s Braking level: 0 to 100 % of rated current			
Enclosure (IEC60529)		IP20, UL open type*10			
Cooling method		Fan cooling			
Weight [lbs (kg)]		4.0 (1.8)	4.0 (1.8)	5.5 (2.5)	

*1 Fuji 4-pole standard motors

*2 The rated capacity is for 230 V output voltage.

*3 Output voltages cannot exceed the power supply voltage.

*4 Use the inverter at the current given in () or below when the carrier frequency is higher than 4 kHz ($f_{cr} = 4$ to 15) or the ambient temperature is 40°C (140°F) or higher.

*5 Tested under the standard load condition (85% load for applicable motor rating).

*6 Calculated under Fuji-specified conditions.

*7 Indicates the value when using a DC reactor (option).

*8 Average braking torque obtained with the AVR control off ($f_{br} = 0$). (Varies according to the efficiency of the motor.)

*9 Interphase voltage unbalance (%) = $\frac{\text{Max.voltage (V)} - \text{Min.voltage (V)}}{3\text{-phase average voltage (V)}} \times 67$ (Refer to IEC 61800-3 (5.2.3))

If this value is 2 to 3 %, use an AC reactor (ACR).

*10 Making FRENIC-Mini conform to category TYPE1 of the UL Standard (or NEMA1) requires an optional NEMA1 kit. Note that the TYPE1-listed FRENIC-Mini should be used in the ambient temperature range from -10 to +40°C (+14 to +104°F).

8.2.2.2 Three-phase 460 V

Item		Specifications			
Power supply voltage		Three-phase 460 V			
Type (FRN ___ C1S-4U21)		002	003	005	
Applicable motor rating (HP)		*1 2	3	5	
Output Ratings	Rated capacity (kVA)	*2 2.8	4.1	6.8	
	Rated voltage (V)	*3 Three-phase, 380, 400, 415 V/50 Hz, 380, 400, 440, 460 V/60 Hz			
	Rated current (A)	3.7	5.5	9.0	
	Overload capability	150 % of rated output current for 1 min. 200 % of rated output current for 0.5 s			
	Rated frequency (Hz)	50, 60 Hz			
Input Ratings	Phases, voltage, frequency	Three-phase, 380 to 480 V, 50/60 Hz			
	Voltage and frequency variations	Voltage : +10 to -15 % (Interphase voltage unbalance*8: 2 % or less) Frequency: +5 to -5 %			
	Momentary voltage dip capability	*4 When the input voltage is 300 V or more, the inverter may keep running. Even if it drops below 300 V, the inverter may keep running for 15 ms.			
	Rated current (A)	(w/ DCR)	3.0	4.4	7.3
		(w/o DCR)	5.9	8.2	13.0
Required power supply capacity (kVA)	*6	2.0	2.9	4.9	
Braking	Torque (%)	*7 150	100	100	
	Braking time (s)	18	12	8	
	Duty cycle (%)	3	2	1.5	
	DC injection braking	Starting frequency: 0.0 to 60.0 Hz Braking time: 0.0 to 30.0 s Braking level: 0 to 100 % of rated current			
Enclosure (IEC60529)		IP20, UL open type*9			
Cooling method		Fan cooling			
Weight [lbs (kg)]		4.0 (1.8)	4.0 (1.8)	5.5 (2.5)	

*1 Fuji 4-pole standard motors

*2 The rated capacity is for 460 V output voltage.

*3 Output voltages cannot exceed the power supply voltage.

*4 Tested under the standard load condition (85% load for applicable motor rating).

*5 Calculated under Fuji-specified conditions.

*6 Indicates the value when using a DC reactor (option).

*7 Average braking torque obtained with the AVR control off ($F_{\square} = \square$). (Varies according to the efficiency of the motor.)

*8 Interphase voltage unbalance (%) = $\frac{\text{Max.voltage (V)} - \text{Min.voltage (V)}}{3\text{-phase average voltage (V)}} \times 67$ (Refer to IEC 61800-3 (5.2.3))

If this value is 2 to 3 %, use an AC reactor (ACR).

*9 Making FRENIC-Mini conform to category TYPE1 of the UL Standard (or NEMA1) requires an optional NEMA1 kit. Note that the TYPE1-listed FRENIC-Mini should be used in the ambient temperature range from -10 to +40°C (+14 to +104°F).

8.3 Common Specifications

	Item	Detail specifications	Related function code	
Output frequency	Maximum frequency	25 to 400 Hz	F03	
	Base frequency	25 to 400 Hz	F04	
	Starting frequency	0.1 to 60.0 Hz	F23	
	Carrier frequency	0.75 k to 15 kHz Frequency may drop automatically to protect the inverter running at 7 kHz or more. This protective operation can be cancelled by function code H98.	F26, F27 H98	
	Accuracy (Stability)	Analog setting: $\pm 0.2\%$ of maximum frequency (at $25 \pm 10^\circ\text{C}$ ($77 \pm 50^\circ\text{F}$)) Digital setting: $\pm 0.01\%$ of maximum frequency (at -10 to $+50^\circ\text{C}$ ($+14$ to $+122^\circ\text{F}$))		
Setting resolution	Analog setting: 1/1000 of maximum frequency (e.g. 0.06 Hz at 60 Hz, 0.4 Hz at 400 Hz) (Includes the built-in potentiometer on the keypad.) Keypad setting: 0.01 Hz (99.99 Hz or less), 0.1 Hz (100.0 Hz or more) (Setting with \wedge , \vee keys.) Link setting: Selectable from 2 types • 1/20000 of maximum frequency (e.g. 0.003 Hz at 60 Hz, 0.02 Hz at 400 Hz) • 0.01 Hz (fixed)			
Control method	V/f control (Simplified torque-vector control)			
Control	Voltage/frequency characteristics	• Possible to set output voltage at base frequency and at maximum frequency (common specifications). Three-phase 230 V, single-phase 230 V: 80 to 240 V Three-phase 460 V: 160 to 500 V • AVR control can be turned ON or OFF (Factory setting: OFF).	F03 to F05	
	(Non-linear V/f pattern)	1 point (Desired voltage and frequency can be set.)	H50, H51	
	Torque boost	Torque boost can be set with the function code F09. (Sets when 0, 1, 3, or 4 is selected at F37.)	F09, F37	
	(Load selection)	Select application load type with the function code F37. 0: Variable torque load increasing in proportion to the square of speed 1: Constant torque load 2: Auto-torque boost 3: Auto-energy saving operation (Variable torque load increasing in proportion to the square of speed during acceleration/deceleration) 4: Auto-energy saving operation (Constant torque load during acceleration/deceleration) 5: Auto-energy saving operation (Auto torque boost during acceleration/deceleration)	F09, F37	
	Starting torque	150% or more (Automatic torque boost in 5 Hz operation)		
	Start/stop	Keypad operation: Start (forward/reverse) and stop with RUN and STOP keys (Remote keypad is also usable.) External signal (5 digital inputs): FWD, REV, coast-to-stop command, etc. Link operation: Communication via RS-485 (RS-485 communications functions are optional.)	F02	
	Frequency setting	Can be set with built-in potentiometer (standard)		F01, C30
		Can be set with \wedge / \vee key (Remote keypad is also usable.)		F01, C30
		Can be set with external potentiometer (1 to 5 k Ω) • Connected to analog input terminals 13, 12, and 11. • Potentiometer must be provided.		F01, C30
		Analog input (Inverse mode operation)	• Can be set with external voltage/current output • 0 to +10 VDC (0 to +5 VDC)/0 to 100 % (terminal 12) • 4 to 20 mA DC /0 to 100 % (terminal C1) • Can be reversed with digital input signal (IVS) • +10 to 0 VDC (+5 to 0 VDC)/0 to 100 % (terminal 12) • 20 to 4 mA DC/0 to 100 % (terminal C1)	E01 to E03 E98, E99
		Multistep frequency: Selectable from 8 steps (step 0 to 7) Link operation: Can be set with communication via RS-485 (RS485 communications functions are optional.)	C05 to C11	
	Running status signal	Transistor output (1 point) : RUN, FAR, FDT, LU, etc. Relay output (1 point) : Alarm relay output or multi-purpose relay output signal Analog output (1 point) : Output frequency, output current, output voltage, input power, etc.	E20 E27 F30, F31	
	Acceleration/deceleration time	0.00 to 3600 s * If 0.00 s is set, the time setting is cancelled and acceleration and deceleration is made according to the pattern given with an external signal. Acceleration and deceleration time can be independently set and selected with digital input signal (1 point).	F07, F08 E10, E11	
(Pattern)	Acceleration and deceleration pattern can be selected from 4 types: Linear, S-curve (weak), S-curve (strong), Curvilinear	H07		
Frequency limiter (peak and bottom limiters)	Peak and bottom can be set.	F15 F16		
Bias frequency	Bias of set frequency and PID command can be independently set.	F18 C50 to C52		
Gain for frequency command	Proportional relation between analog input signal and output frequency can be set. (Voltage signal (terminal 12) and current signal (terminal C1) can be set independently.) e.g. When voltage input signal is between 0 and +5 VDC, the inverter can be used at 5 VDC/max output frequency by setting gain to 200 %	C32 to C39		
Jump frequency control	3 operation points and their common jump hysteresis width (0 to 30 Hz) can be set.	C01 to C04		
Jogging operation	• Can be operated using digital input signal or keypad. • Acceleration and deceleration time (same duration used only for jogging) can be set. • Jogging frequency: 0.00 to 400.0 Hz	H54 C20		
Timer operation	Operation starts and stops at the time set from keypad (1 cycle).	C21		
Auto-restart after instantaneous power failure	Restarts the inverter without stopping the motor after instantaneous power failure.	F14		
Slip compensation	• Compensates for decrease in speed according to the load, enabling stable running.	P09		
Current limit	• Keeps the current under the preset value.	F43, F44		

Item	Detail specifications	Related function code
Control	PID control PID control is possible using analog input signals. Inverse mode operation can be set using digital input signal (IVS) or the function code J01. (Select the control mode with J01.) Process commands (Select the kind of remote process command with J02, E60 to E62.) + (▲) (▼) key operation: Set frequency (Hz)/Max frequency (Hz) × 100 (%) * Built-in potentiometer * Voltage input (terminal 12) : 0 to +10 VDC/0 to 100 % * Current input (terminal C1) : +4 to +20 mADC/0 to 100 % * RS-485 communication : Set frequency (Hz)/Max frequency (Hz) × 100 (%) Feedback signal (Feedback signal can be selected with E61 and E62.) * Voltage input (terminal 12) : 0 to +10 VDC/0 to 100 % * Current input (terminal C1) : +4 to +20 mADC/0 to 100 %	J01 J02 E60 E61 E62 J02 E61 E62
	Automatic deceleration Makes the deceleration time 3 times longer to avoid <i>DU</i> trip when DC link circuit voltage exceeds the overvoltage limit. (Set at the function code H69 = 1.) * Trip may occur even when deceleration time is prolonged if the moment of inertia is large. * This function does not come ON during constant speed operation.	H69
	Overload prevention control Prevents tripping before the inverter becomes overloaded.	H70
	Energy saving operation * Minimizes motor losses at light load. * Can be set in accordance with the kind of load (variable torque load increasing in proportion to the square of speed, constant torque load, automatic torque boost).	F37
	Fan stop operation Detects inverter internal temperature and stops cooling fan when the temperature is low.	H06
	Running * Speed monitor, output current (A), output voltage (V), input power (HP), PID process command, PID feedback value * Select the speed monitor to be displayed from the following: * Output frequency (before slip compensation) (Hz), output frequency (after slip compensation) (Hz), set frequency (Hz), load shaft speed (r/min), line speed (ft/min), constant feeding rate time. * Speed monitor can display the speed set at E48.	E43 E48
Stopping Displays the same contents as displayed during running.	Same as above	
Indication	Alarm mode Displays the cause of trip by codes as follows. <i>OC1</i> : Overcurrent during acceleration <i>OC2</i> : Overcurrent during deceleration <i>OC3</i> : Overcurrent at constant speed <i>Lr n</i> : Input phase loss <i>UV</i> : Undervoltage <i>OPL</i> : Output phase loss <i>OU1</i> : Overvoltage during acceleration <i>OU2</i> : Overvoltage during deceleration <i>OU3</i> : Overvoltage during constant speed <i>OH1</i> : Overheating of the heat sink <i>OH2</i> : External thermal relay tripped <i>OH4</i> : Motor protection (PTC thermistor) <i>dbH</i> : Overheating of the DB circuit <i>OL</i> : Motor overload <i>OLU</i> : Inverter unit overload <i>Er1</i> : Memory error <i>Er2</i> : Remote keypad communications error <i>Er3</i> : CPU error <i>Er5</i> : Operation procedure error <i>Er8</i> : RS-485 error <i>ErF</i> : Data save error due to undervoltage For details, refer to Section 8.8, "Details of Protective Functions"	
	Running or Alarm mode Alarm history: Saves and displays the last 4 trip codes and their detailed description. (Even with the main power off, the alarm history data of the last 4 trips are retained.)	
	Overcurrent Protects the inverter to stop the inverter output when the following overcurrent flows during acceleration, deceleration, or constant speed rotation: * Overcurrent caused by overload (Short-circuit) (Ground fault) * Overcurrent caused by short-circuit in output circuit * Overcurrent caused by ground fault (Ground fault can be detected at starting.)	
	Overvoltage Stops the inverter output by detecting overvoltage in DC link circuit during braking. Three-phase and single-phase 230 V: 400 VDC three-phase 460 V: 800 VDC	
Protection	Incoming surge Protects the inverter from surge voltage entering between main circuit power and grounding wires.	
	Undervoltage Stops the inverter output by detecting voltage drop in DC link circuit. Three-phase and single-phase 230 V: 200 VDC three-phase 460 V: 800 VDC Details of operation can be selected with the function code F14.	F14
	Input phase loss Stops the inverter output or protects the inverter against input phase loss. Non-operation is also selectable.	H98
	Output phase loss Stops the inverter output by detecting output phase loss at the start running or during running. Non-operation is also selectable.	H98
	Overheating (Heat sink) (Braking resistor) Stops the inverter output by detecting inverter heat sink temperature. Stops the inverter output and built-in braking resistor if "discharging capability" or "allowable average loss" set for the braking resistor is exceeded more frequently than the set values.	F50, F51
	Overload Stops the inverter output by detecting the output current and internal temp. To calculate the insulated gate bipolar transistor (IGBT) internal temp.	
	Motor protection (Electronic thermal) (PTC thermistor) (Overload early warning) Stops the inverter output for motor protection when the set output current is exceeded. Thermal time constant can be adjusted (0.5 to 75.0 min). A PTC thermistor input stops the inverter output for motor protection. Warning signal can be output based on the set level before the inverter trips. Related transistor output: OL	F10 to F12, P99 H26, H27 F10, F12, E3A, E35, P99
	Retry function When the inverter trips and stop the inverter output, this function automatically resets the tripping state and restarts running. (Waiting time before resetting and the number of retry times can be set.) Activated when the motor is tripped with the following trip codes: <i>OC1</i> , <i>OC2</i> , <i>OC3</i> , <i>OU1</i> , <i>OU2</i> , <i>OU3</i> , <i>OH1</i> , <i>OH4</i> , <i>dbH</i> , <i>OL</i> , <i>OLU</i>	H04, H05
	Installation location Shall be free from corrosive gases, flammable gases, oil mist, dusts, and direct sunlight. Indoor use only. (Pollution degree 2 when the Low Voltage Directives are used.)	
	Ambient temp. -10 to +50 °C (+14 to +122 °F) (-10 to 40 °C (+14 to +104 °F) when inverters are installed side-by-side without clearance.)	
Ambient humidity 5 to 95 %RH (no condensation)		
Environment	Altitude Altitude [ft (m)] Output derating 3,300 or lower (1,000 or lower) None * If the altitude exceeds 6,600 ft (2000 m), 3,301 to 6,600 (1,001 to 2,000) None insulate the interface circuit from the main power 6,601 to 9,800 (2,001 to 3,000) Decreases* supply to conform to the Low Voltage Directives.	
	Vibration 0.12 ft (3 mm) (vibration width): 2 to less than 9 Hz. 32.2 ft/s ² (9.8 m/s ²): 9 to less than 20 Hz 6.6 ft/s ² (2 m/s ²): 20 to less than 55 Hz. 3.3 ft/s ² (1 m/s ²): 55 to less than 200 Hz	
	Storage Ambient temp. -25 to +70 °C (-13 to +158 °F)	
	Storage Ambient humidity 5 to 95 %RH (no condensation)	

8.4 Terminal Specifications

8.4.1 Terminal functions

Main circuit and analog input terminals

Classification	Symbol	Name	Functions	Related function codes
Main circuit	L1/R, L2/S, L3/T	Main circuit power input	Connects a three-phase power supply. (three-phase 230V, 460V)	
	L1/L, □, L2/N		Connects a single-phase power supply. □ indicates the no connection terminal. (Single-phase 230V)	
	U, V, W	Inverter output	Connects a three-phase induction motor.	
	P1, P(+)	For DC reactor	Connects a DC reactor.	
	P(+), N(-)	DC link bus	Connects a DC power device.	
	P(+), DB	For braking resistor	Used for connection of the optional external braking resistor. (Wiring is required even for the braking resistor built-in type.)	
	 G	Grounding	Grounding terminal for inverter chassis (Two terminals are provided.)	
Analog input	[13]	Potentiometer power supply	Power supply (+10 VDC) for frequency command potentiometer (Potentiometer: 1 to 5 kΩ) Allowable maximum output current: 10 mA	
	[12]	Voltage input (Normal operation) (Inverse operation)	The frequency is set according to the external analog input voltage. 0 to +10 VDC/0 to 100 % 0 to +5 VDC/0 to 100 % or +1 to +5 VDC/0 to 100 % can be selected by function code setting. +10 to 0 VDC/0 to 100 % (switchable by digital input signal)	F18, C32 to C34
		(PID control)	Used for reference signal (PID process command) or PID feedback signal.	E61
		(Frequency auxiliary setting)	Used as additional auxiliary setting to various main settings of frequency.	E61
		Electric characteristics of terminal [12] • Input impedance: 22 kΩ • Allowable maximum input voltage: 15 VDC (If the input voltage is +10 VDC or over, the inverter assumes it to be +10 VDC.)		
[C1]	Current input (Normal operation) (Inverse operation)	The frequency is set according to the external analog input current command. +4 to +20 mADC/0 to 100% +20 to +4 mADC/0 to 100 % (switchable by digital input signal)	F18, C37 to C39	
	(PID control)	Used for reference signal (PID process command) or PID feedback signal.	E62	

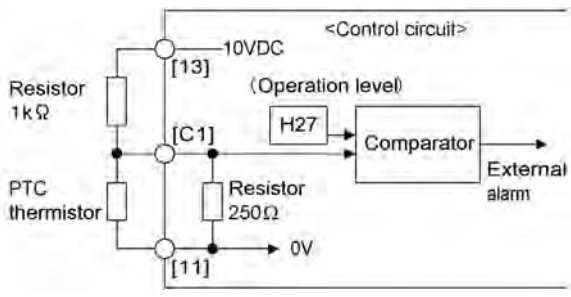
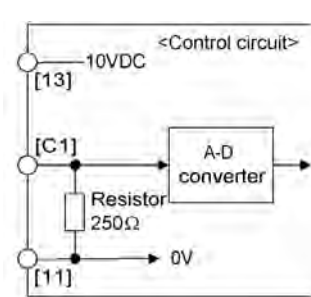
Classification	Symbol	Name	Functions	Related function codes
Analog input	[C1]	(For PTC thermistor)	<p>Connects a PTC thermistor for motor protection. (Connect an 1 kΩ external resistor to terminal [13] - [C1].)</p> 	H26, H27
		(Frequency auxiliary setting)	Used as additional auxiliary setting to various main settings of frequency.	E62
			<p>Electric characteristics of terminal [C1]</p> <ul style="list-style-type: none"> • Input impedance: 250 Ω • Allowable maximum input current: +30 mADC (If the input current exceeds +20 mADC, the inverter will limit it at +20 mADC.) 	
	[11]	Analog common	Common for analog input signals ([13], [12], [C1]) (Isolated from terminals [CM] and [Y1E].)	

Classification	Symbol	Name	Functions	Related function codes
Analog input			<p>Note</p> <ul style="list-style-type: none"> • Since weak analog signals are handled, these signals are especially susceptible to the external noise effects. Route the wiring as short as possible (within 66 ft (20 m)) and use shielded wires. In principle, ground the shielding layer of the shielded wires; if effects of external inductive noises are considerable, connection to terminal [11] may be effective. As shown in Figure 8.1, ground the single end of the shield to enhance the shielding effect. • Use a twin contact relay for weak signals if the relay is used in the control circuit. Do not connect the relay's contact to terminal [11]. • When the inverter is connected to an external device outputting the analog signal, a malfunction may be caused by electric noise generated by the inverter. If this happens, according to the circumstances, connect a ferrite core (a toroidal core or an equivalent) to the device outputting the analog signal and/or connect a capacitor having the good cut-off characteristics for high frequency between control signal wires as shown in Figure 8.2. • Do not apply a voltage of +7.5 VDC or higher to terminal [C1]. Doing so could damage the internal control circuit. 	
			Figure 8.1 Connection of Shielded Wire	Figure 8.2 Example of Electric Noise Prevention

Digital input terminals

Classification	Symbol	Name	Functions	Related function codes																							
Digital input	[X1]	Digital input 1	<p>The following features can be set to terminals [X1] - [X3], [FWD] and [REV] and the commands function according to the input signals at the terminals.</p> <p>The commands (FWD) and (REV) are factory setting assigned at terminals [FWD] and [REV], respectively.</p> <p>Common features</p> <ul style="list-style-type: none"> Sink/Source switching feature: Sink and source can be switched by using the built-in jumper switch. Normal/negative logic input switching feature: Switches the logic value (1/0) for ON/OFF of terminals between [X1] to [X3], [FWD] or [REV], and [CM]. If the logic value for ON between [X1] and [CM] is 1 in the normal logic system, for example, OFF is 1 in the negative logic system. <p>Digital input circuit specifications</p> <table border="1"> <thead> <tr> <th>Item</th> <th>Min.</th> <th>Max.</th> </tr> </thead> <tbody> <tr> <td rowspan="2">Operation voltage (SINK)</td> <td>ON level</td> <td>0V</td> <td>2V</td> </tr> <tr> <td>OFF level</td> <td>22V</td> <td>27V</td> </tr> <tr> <td rowspan="2">Operation voltage (SOURCE)</td> <td>ON level</td> <td>22V</td> <td>27V</td> </tr> <tr> <td>OFF level</td> <td>0V</td> <td>2V</td> </tr> <tr> <td>Operation current at ON (Input voltage at 0 V)</td> <td>2.5mA</td> <td>5mA</td> </tr> <tr> <td>Allowable leakage current at OFF</td> <td>-</td> <td>0.5mA</td> </tr> </tbody> </table>	Item	Min.	Max.	Operation voltage (SINK)	ON level	0V	2V	OFF level	22V	27V	Operation voltage (SOURCE)	ON level	22V	27V	OFF level	0V	2V	Operation current at ON (Input voltage at 0 V)	2.5mA	5mA	Allowable leakage current at OFF	-	0.5mA	E01 to E03
	Item	Min.		Max.																							
	Operation voltage (SINK)	ON level		0V	2V																						
		OFF level	22V	27V																							
	Operation voltage (SOURCE)	ON level	22V	27V																							
		OFF level	0V	2V																							
Operation current at ON (Input voltage at 0 V)	2.5mA	5mA																									
Allowable leakage current at OFF	-	0.5mA																									
[X2]	Digital input 2																										
[X3]	Digital input 3																										
[FWD]	Forward operation command	E98, E99																									
[REV]	Reverse operation command																										
[PLC]	PLC signal power	Connects to PLC output signal power supply. (Rated voltage: +24 VDC, Maximum output current: 50 mA)																									
[CM]	Digital common	Common for digital input signals (Isolated from terminals [11] and [Y1E].)																									

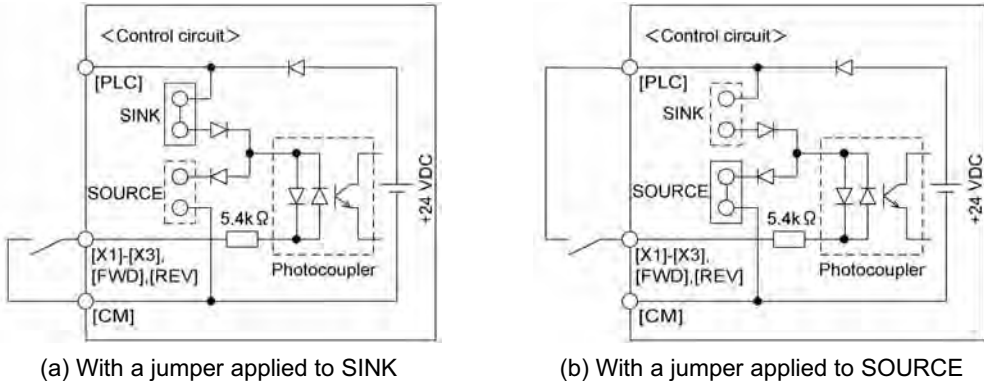
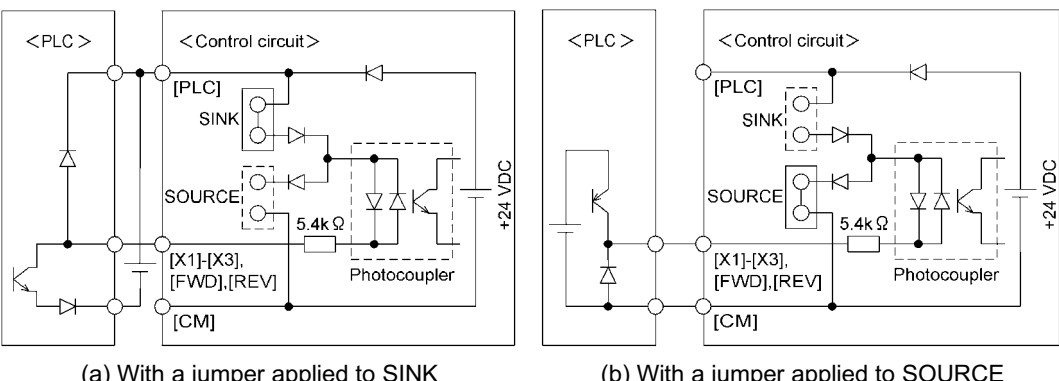
Classification	Symbol	Name	Functions	Related function codes
Digital input	<p>Tip</p> <p>■ Turning ON or OFF [X1], [X2], [X3], [FWD], or [REV] using a relay contact</p> <p>Figure 8.3 shows two examples of a circuit that turns ON or OFF control signal input [X1], [X2], [X3], [FWD], or [REV] using a relay contact. Circuit (a) has a connecting jumper applied to SINK, whereas circuit (b) has it applied to SOURCE.</p> <p>NOTE: To configure this kind of circuit, use a highly reliable relay (Recommended product: Fuji control relay Model HH54PW.)</p>  <p>(a) With a jumper applied to SINK (b) With a jumper applied to SOURCE</p> <p>Figure 8.3 Circuit Configuration Using a Relay Contact</p>			
		<p>■ Turning ON or OFF [X1], [X2], [X3], [FWD], or [REV] using a programmable logic controller (PLC)</p> <p>Figure 8.4 shows two examples of a circuit that turns ON or OFF control signal input [X1], [X2], [X3], [FWD], or [REV] using a programmable logic controller (PLC). Circuit (a) has a connecting jumper applied to SINK, whereas circuit (b) has it applied to SOURCE.</p> <p>In circuit (a) below, short-circuiting or opening the transistor's open collector circuit in the PLC using an external power source turns ON or OFF control signal [X1], [X2], [X3], [FWD], or [REV]. When using this type of circuit, observe the following:</p> <ul style="list-style-type: none"> • Connect the + node of the external power source (which should be isolated from the PLC's power) to terminal [PLC] of the inverter. • Do not connect terminal [CM] of the inverter to the common terminal of the PLC.  <p>(a) With a jumper applied to SINK (b) With a jumper applied to SOURCE</p> <p>Figure 8.4 Circuit Configuration Using a PLC</p>		

For details about the jumper setting, refer to the FRENIC-Mini Instruction Manual, Chapter 2, Section 2.3.8 "Switching of SINK/SOURCE (jumper switch)."

■ Commands assigned at digital input terminals

Classification	Command	Command name	Functions	Related function codes																																																		
Commands assigned on digital input terminals	(FWD)	Run forward command	[FWD] - [CM] ON: The motor runs forward. [FWD] - [CM] OFF: The motor decelerates and stops. When the [FWD] - [CM] and [REV] - [CM] are simultaneously ON, the inverter immediately decelerates and stops the motor. This command can be set only for terminals [FWD] and [REV].	E98 = 98																																																		
	(REV)	Run reverse command	[REV] - [CM] ON: The motor runs reverse. [REV] - [CM] OFF: The motor decelerates and stops. When [FWD] - [CM] and [REV] - [CM] are simultaneously ON, the inverter immediately decelerates and stops the motor. This command can be set only for terminals [FWD] and [REV].	E99 = 99																																																		
	(SS1) (SS2) (SS4)	Multistep frequency selection	Select 2 (0 and 1) step multi frequency running. Select 4 (0 to 3) step multi frequency running. Select 8 (0 to 7) step multi frequency running. Multistep frequency 0 indicates the frequency set by the keypad, built-in potentiometer or analog signal. <table border="1" style="margin: 10px auto;"> <thead> <tr> <th colspan="2"></th> <th colspan="8">Multistep frequency</th> </tr> <tr> <th>Digital input</th> <th></th> <th>0</th> <th>1</th> <th>2</th> <th>3</th> <th>4</th> <th>5</th> <th>6</th> <th>7</th> </tr> </thead> <tbody> <tr> <td>(SS1)</td> <td></td> <td>-</td> <td>ON</td> <td>-</td> <td>ON</td> <td>-</td> <td>ON</td> <td>-</td> <td>ON</td> </tr> <tr> <td>(SS2)</td> <td></td> <td>-</td> <td>-</td> <td>ON</td> <td>ON</td> <td>-</td> <td>-</td> <td>ON</td> <td>ON</td> </tr> <tr> <td>(SS4)</td> <td></td> <td>-</td> <td>-</td> <td>-</td> <td>-</td> <td>ON</td> <td>ON</td> <td>ON</td> <td>ON</td> </tr> </tbody> </table> Assigns the commands (SS1), (SS2), and (SS4) to terminals [X1], [X2], and [X3], respectively.			Multistep frequency								Digital input		0	1	2	3	4	5	6	7	(SS1)		-	ON	-	ON	-	ON	-	ON	(SS2)		-	-	ON	ON	-	-	ON	ON	(SS4)		-	-	-	-	ON	ON	ON	ON	E01 = 0 E02 = 1 E03 = 2 C05 to C11 = 0.00 to 400.0 Hz
			Multistep frequency																																																			
	Digital input		0	1	2	3	4	5	6	7																																												
(SS1)		-	ON	-	ON	-	ON	-	ON																																													
(SS2)		-	-	ON	ON	-	-	ON	ON																																													
(SS4)		-	-	-	-	ON	ON	ON	ON																																													
(RT1)	ACC/DEC time selection	[X1] - [CM]: ON Acceleration and deceleration time 2 is effective. [X1] - [CM]:OFF Acceleration and deceleration time 1 is effective. (Acceleration and deceleration time by link operation is effective.) (e.g.) Assigns the command (RT1) to terminal [X1].  Note Switchable during the acceleration or deceleration operation	E01 = 4 E10, E11 = 0.00 to 3600 s S08, S09 = 0.00 to 3600 s																																																			
(HLD)	3-wire operation stop command	Used for 3-wire operation. [X2] - [CM] ON: The inverter self-holds the command (FWD) or (REV). [X2] - [CM] OFF: The inverter releases self-holding. (e.g.) Assigns the command (HLD) to terminal [X2].	E02 = 6																																																			

Classification	Command	Command name	Functions	Related function codes
Commands assigned on digital input terminals	(BX)	Coast-to-stop command	[X3] - [CM] ON: The inverter output is stopped immediately and the motor will coast-to-stop. (No alarm signal will be output.) (e.g.) Assigns the command (BX) to terminal [X3].	E03 = 7
	(RST)	Alarm reset	[X1] - [CM] ON: Alarm status is reset. (ON signal should be held for 0.1 s or longer.) (e.g.) Assigns the command (RST) to terminal [X1].	E01 = 8
	(THR)	Alarm from external equipment	[X2] - [CM] OFF: The inverter output is stopped and the motor coasts-to-stop. Alarm signal for the alarm code <i>OH2</i> will be output. (e.g.) Assigns the command (THR) to terminal [X2].	E02 = 9
	(JOG)	Jogging operation	[X3] - [CM] ON: Jogging operation is effective. (FWD) or (REV) ON: The inverter runs the motor with jogging frequency. (e.g.) Assigns the command (JOG) to terminal [X3].	E03 = 10 C20 = 0.00 to 400.0 Hz H54 = 0.00 to 3600 s
	(Hz2/Hz1)	Freq. set2/ Freq. set1	[X1] - [CM] ON: Frequency command source 2 is effective. (e.g.) Assigns the command (Hz2/Hz1) to terminal [X1].	E01 = 11 F01 = 0 to 4 C30 = 0 to 4
	(WE-KP)	Write enable for keypad	[X2] - [CM] ON: The function code data can be changed from the keypad. (Data can be changed when this function is not allocated.) (e.g.) Assigns the command (WE-KP) to terminal [X2].	E02 = 19
	(Hz/PID)	PID control cancel	[X3] - [CM] ON: The PID control is cancelled, and the set frequency is set by the Multistep frequency, keypad or analog input. (e.g.) Assigns the command (Hz/PID) to terminal [X3].  For details about J01 to J06 data, refer to Chapter 9, "FUNCTION CODES."	E03 = 20 J01 to J06 F01 = 0 to 4 C30 = 0 to 4
(IVS)	Inverse mode changeover	[X1] - [CM] ON: Normal mode operation or inverse mode operation can be changed in the frequency command and PID control. (e.g.) Assigns the command (IVS) to terminal [X1].	E01 = 21	

Classification	Command	Command name	Functions	Related function codes
Commands assigned on digital input terminals	(LE)	Link enable	[X2] - [CM] ON: The link operation is effective. (RS-485 communications card (option) or models available on order) (e.g.) Assigns the command (LE) to terminal [X2].	E02 = 24 H30 = 3 y99 = 1
	(PID-RST)	PID integral/differential reset	[X3] - [CM] ON: PID integration and differentiation are reset. (e.g.) Assigns the command (PID-RST) to terminal [X3].	E03 = 33
	(PID-HLD)	PID integral hold	[X1] - [CM] ON: PID integration is temporarily stopped. (e.g.) Assigns the command (PID-HLD) to terminal [X1].	E01 = 34

Analog output, transistor output, and relay output terminals

Classification	Symbol	Name	Functions	Related function codes											
Analog output	[FMA]	Analog monitor	<p>The monitor signal for analog DC voltage (0 to +10 VDC) is output. The signal functions can be selected with the function code <i>F31</i> from the following.</p> <ul style="list-style-type: none"> • Output frequency (before slip compensation) • Output frequency (after slip compensation) • Output current • Output voltage • Input power • PID feedback value • DC link bus voltage • Analog output test (+) <p>(Output voltage: 0 to +10 VDC, maximum current: 2 mA Up to two analog voltmeters can be connected.)</p>	F30, F31											
	[11]	Analog common	<p>Common for analog output signal ([FMA])</p> <p>This terminal is electrically isolated from terminals [CM] and [Y1E].</p>												
Transistor output	[Y1]	Transistor output	<p>Commands listed below can be assigned to terminal [Y1] and the signal is output according to the command.</p> <p>Normal/negative logic output switching feature: Switches the logic value (1/0) for ON/OFF of the terminals between [Y1] and [Y1E]. If the logic value for ON between [Y1] and [Y1E] is 1 in the normal logic system, for example, OFF is 1 in the negative logic system.</p> <p>Digital output circuit specification</p> <table border="1"> <thead> <tr> <th>Item</th> <th>Max.</th> </tr> </thead> <tbody> <tr> <td rowspan="2">Operation voltage</td> <td>ON level</td> <td>2V</td> </tr> <tr> <td>OFF level</td> <td>27V</td> </tr> <tr> <td>Maximum load current at ON</td> <td>50mA</td> </tr> <tr> <td>Leakage current at OFF</td> <td>0.1mA</td> </tr> </tbody> </table> <p>Figure 8.5 shows examples of connection between the control circuit and a PLC.</p> <p>Note</p> <ul style="list-style-type: none"> • Check the polarity of an external power input. • To connect a control relay, connect a surge absorbing diode across the coil of the relay. 	Item	Max.	Operation voltage	ON level	2V	OFF level	27V	Maximum load current at ON	50mA	Leakage current at OFF	0.1mA	E20
	Item	Max.													
Operation voltage	ON level	2V													
	OFF level	27V													
Maximum load current at ON	50mA														
Leakage current at OFF	0.1mA														
	[Y1E]	Transistor output common	<p>Common for transistor output signal</p> <p>(Isolated from terminals [CM] and [11].)</p>												

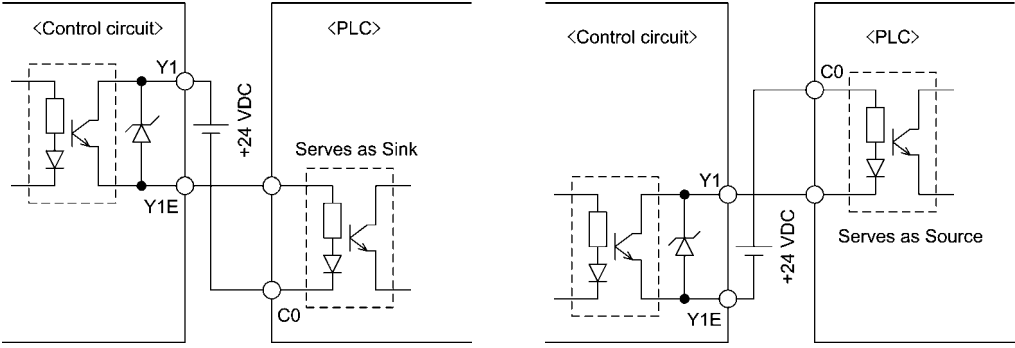
Classification	Symbol	Name	Functions	Related function codes
Transistor output	<p>Tip ■ Connecting Programmable Controller (PLC) to Terminal [Y1]</p> <p>Figure 8.5 shows two examples of circuit connection between the transistor output of the inverter's control circuit and a PLC. In example (a), the input circuit of the PLC serves as the sink for the control circuit, whereas in example (b), it serves as the source for the control circuit.</p>		 <p>(a) PLC serving as Sink</p> <p>(b) PLC serving as Source</p>	
		Relay output	[30A], [30B], [30C]	Alarm relay output (for any fault)

■ Signals assigned at transistor output terminal

Classification	Signal	Signal name	Functions	Related function codes
Signals assigned at transistor output terminal	(RUN)	Inverter running	Comes ON when the output frequency is higher than start frequency.	E20 = 0
	(RUN2)	Inverter output on	Comes ON when the main circuit (gate) is turned ON.	E20 = 35
	(FAR)	Speed/freq. arrival	Comes ON when the motor speed reaches the set frequency. (Condition: Run command is ON.) (Hysteresis width (fixed): 2.5 Hz)	E20 = 1
	(FDT)	Speed/freq. detection	Comes ON when the output frequency is above the detection level and goes OFF when below the detection level. (Hysteresis width (fixed): 1.0 Hz)	E20 = 2 E31
	(LU)	undervoltage detection	Comes ON when the inverter stops its output because of undervoltage while the run command is ON.	E20 = 3
	(IOL)	Inverter output limit (limit on current)	Comes ON when the inverter is limiting the current.	E20 = 5 F43, F44
	(IPF)	Auto-restarting	Comes ON during auto-restarting operation (after instantaneous power failure and until completion of restart).	E20 = 6 F14
	(OL)	Overload early warning (for motor)	Comes ON when the calculated value of electronic thermal relay is higher than the preset alarm level.	E20 = 7 F10 to F12
	(TRY)	Auto-resetting	Comes ON during auto-resetting mode.	E20 = 26 H04, H05
	(LIFE)	Lifetime alarm	Outputs alarm signal according to the preset lifetime level.	E20 = 30 H42, H43
	(OLP)	Overload preventive control	Comes ON during inverter control for avoiding overload.	E20 = 36 H70
	(ID)	Current detection	Comes ON when a current larger than the set value has been detected for the timer-set time.	E20 = 37 E34, E35
	(IDL)	Small current detection	Comes ON when a current smaller than the set value has been detected for the timer-set time.	E20 = 41 E34, E35
	(ALM)	Alarm relay (for any fault)	Alarm signal is output as the transistor output signal.	E20 = 99

RS-485 communications port

Classification	Connector	Name	Functions	Related function codes
Communication	RS-485 port*	RS-485 communications I/O	<p>(1) Used to connect the inverter with PC or PLC using RS-485 port.</p> <p>(2) Used to connect the inverter with the remote keypad. The inverter supplies the power to the remote keypad through the extension cable.</p> <p>RJ-45 connector is used.</p> <p>For the transmission specifications, refer to Chapter 6, Section 6.4.2 [2] "RS-485 communications card."</p>	H30, y01 to y10 y99

* This terminal is valid when the standard inverter is equipped with RS-485 communications card (option).



- Route the wiring of the control terminals as far from the wiring of the main circuit as possible. Otherwise electric noise may cause malfunctions.
- Fix the control circuit wires inside the inverter to keep them away from the live parts of the main circuit (such as the terminal block of the main circuit).

8.4.2 Terminal block arrangement

The terminal blocks shown below. They differ according to the power supply voltage and the applicable motor rating.

 For details about terminal arrangement, refer to Section 8.4.3, "Terminal arrangement diagram and screw specifications."

Power supply voltage	Applicable motor rating (HP)	Inverter type	Refer to
Three-phase 230 V	1/8	FRNF12C1 ■-2U	Figure A
	1/4	FRNF25C1 ■-2U	
	1/2	FRNF50C1 ■-2U	
	1	FRN001C1 ■-2U	
	2	FRN002C1 ■-2U	
	3	FRN003C1 ■-2U	
	5	FRN005C1 ■-2U	
Three-phase 460 V	1/2	FRNF50C1 ■-4U	Figure B
	1	FRN001C1 ■-4U	
	2	FRN002C1 ■-4U	
	3	FRN003C1 ■-4U	
	5	FRN005C1 ■-4U	
Single-phase 230 V	1/8	FRNF12C1 ■-7U	Figure A
	1/4	FRNF25C1 ■-7U	
	1/2	FRNF50C1 ■-7U	
	1	FRN001C1 ■-7U	Figure B
	2	FRN002C1 ■-7U	
	3	FRN003C1 ■-7U	

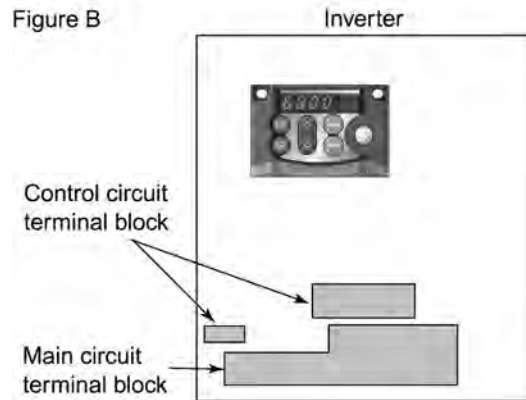
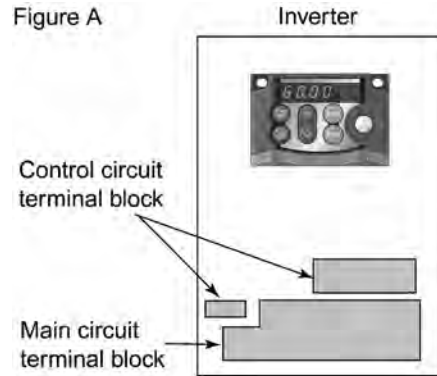

Notes 1) A box (■) in the above table replaces S or E depending on enclosure.

8.4.3 Terminal arrangement diagram and screw specifications

8.4.3.1 Main circuit terminals

The table below shows the main circuit terminal arrangements, screw sizes, and tightening torque. Note that the terminal arrangements differ according to the inverter types. Two terminals designed for grounding shown as the symbol,  in Figures A to D make no distinction between a power supply source (a primary circuit) and a motor (a secondary circuit).

Table 8.1 Main Circuit Terminal Arrangements, Screw Sizes, and Tightening Torque

Power supply voltage	Applicable motor rating (HP)	Inverter type	Refer to	Figure A
Three-phase 230 V	1/8	FRNF12C1■-2U	Figure A	
	1/4	FRNF25C1■-2U		
	1/2	FRNF50C1■-2U		
	1	FRN001C1■-2U		
	2	FRN002C1■-2U		
	3	FRN003C1■-2U		
Three-phase 460 V	5	FRN005C1■-2U	Figure B	
	1/2	FRNF50C1■-4U		
	1	FRN001C1■-4U		
	2	FRN002C1■-4U		
Single-phase 230 V	3	FRN003C1■-4U	Figure C	
	5	FRN005C1■-4U		
	1/8	FRNF12C1■-7U		
	1/4	FRNF25C1■-7U		
Single-phase 230 V	1/2	FRNF50C1■-7U	Figure D	
	1	FRN001C1■-7U		
	2	FRN002C1■-7U		
	3	FRN003C1■-7U		

Notes 1) A box (■) in the above table replaces S or E depending on enclosure.

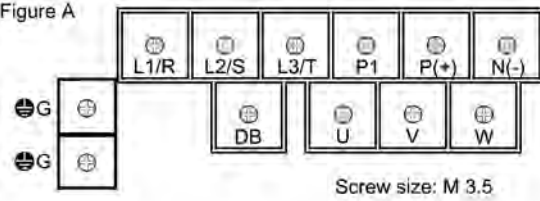
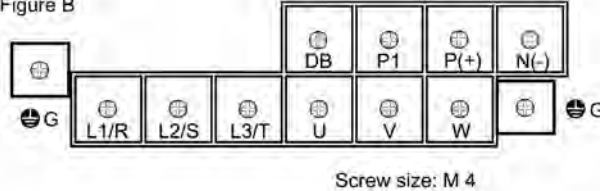
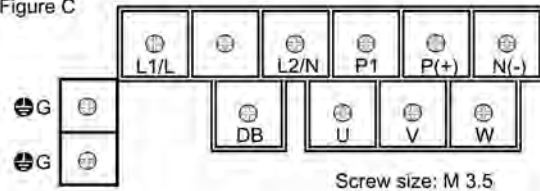
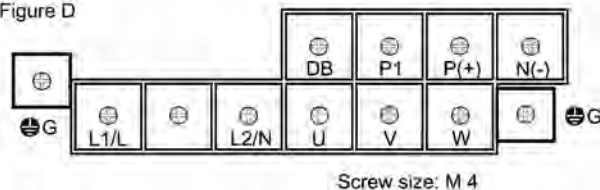

Screw size	Tightening torque
M 3.5	9.7 lb-in (1.2 N·m)
M 4.0	14.6 lb-in (1.8 N·m)

8.4.3.2 Control circuit terminal

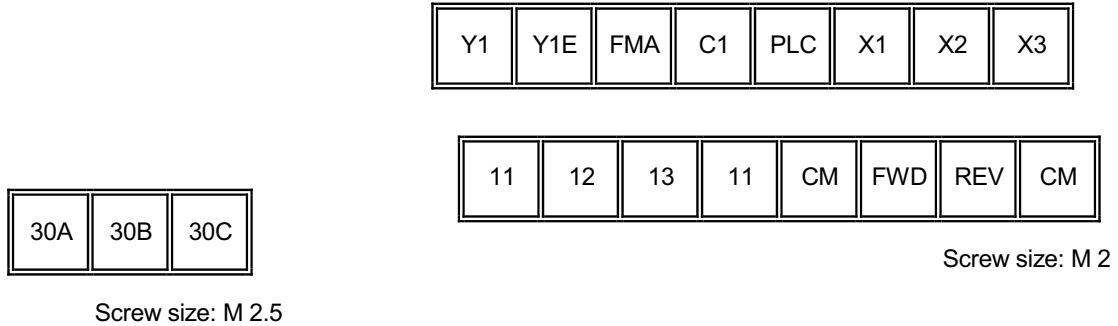
The diagram and table below show the control circuit terminal arrangement, screw sizes, and tightening torque. They are the same in all FRENIC-Mini models.



Screw size	Tightening torque
M 2.0	1.6 lb-in (0.2 N·m)
M 2.5	3.2 lb-in (0.4 N·m)

Terminal symbol	Screwdriver	Allowable wire size	Bared wire length 	Stick terminal (see the table below) Opening dimension in the control terminals 
[30A], [30B], [30C]	Phillips screwdriver (JIS standard) No. 1 screw tip	AWG22 to AWG18 (0.34 to 0.75 mm ²)	0.24 to 0.31 inch (6 to 8 mm)	0.11 (W) x 0.7 (H) inch (2.7 (W) x 1.8 (H) mm)
Other than those above	Phillips screwdriver for precision machine (JCIS standard) No. 0 screw tip	AWG24 to AWG18 (0.25 to 0.75 mm ²)	0.20 to 0.28 inch (5 to 7 mm)	0.07 (W) x 0.06 (H) inch (1.7 (W) x 1.6 (H) mm)

Recommended stick terminal

Manufacturing company: WAGO Company of Japan., Ltd.

Screw size	Wire size	Type (216-□□□)				
		w/ isolation collar		w/o isolation collar		
		Short type	Long type	Short type	Long type	
M 2	M 2.5	AWG24 (0.25 mm ²)	321	301	151	131
		AWG22 (0.34 mm ²)	322	302	152	132
		AWG20 (0.50 mm ²)	221	201	121	101
		AWG18 (0.75 mm ²)	222	202	122	102

The recommended crimping tool is Name: Variocrimp 4, Model No.: 206-204

8.5 Operating Environment and Storage Environment

8.5.1 Operating environment

The operating environment for FRENIC-Mini shows below.

Item	Specifications	Careful site for installation	
Ambient temperature ^{*1}	-10 to +50°C (+14 to 122°F)	Places around heating machines like furnace, constant temperature bath, or boiler Enclosed cases or rooms Tropical region or outdoor machinery Cold room or cold region	
Relative humidity	5 to 95% (No condensation)	Inside of dryer machines for brewing, food or wood processing Transportation equipment for frozen food Inside of tunnel Places where there is much ice and snow Places where water or steam is used	
Atmosphere ^{*2}	Dust	Clean	Foundry, cement plant, spinning mill, fertilizer mill, flouring mill, iron factory, timber mill, construction site, the places around grinder
	Salinity	Little (0.01 mg/cm ² or less per year)	Places like coast or shipping that is susceptible to sea salt
	Oil mist	None	Places where oil like grinding fluid gets mist
	Flammable gas	None	Chemical factory, oil refinery, fuel gas facility, gas station, water treatment plant, hot spring region, geothermal power station, colliery
	Corrosive gas	None	
Altitude ^{*3}	3300 ft (1000 m) or lower	Mountainous region, heights	
Atmospheric pressure	86 - 106 kPa	—	
Vibration	0.12 inch (3 mm) 2 to 9 Hz or lower (Max. amplitude) 32.2 ft/s ² (9.8 m/s ²) 9 - 20 Hz or lower 6.6 ft/s ² (2.0 m/s ²) 20 - 55 Hz or lower 3.3 ft/s ² (1.0 m/s ²) 55 - 200 Hz or lower	Vehicle, shipping, machinery	

*1 The inverter must not be subjected to sudden changes in temperature that will cause condensation to form.

*2 Do not install the inverter in an environment where it may be exposed to cotton waste or moist dust or dirt which will clog the heat sink in the inverter. If the inverter is to be used in such an environment, install it in the control board of your system or other dustproof containers.

*3 If you use the inverter in altitude above 3300 ft (1000 m), you should apply a reduction factor of withstand voltage test and an output current reduction factor as listed below when selecting the inverter properly.

Altitude [ft (m)]	Reduction factor of withstand voltage test	Output current reduction factor
3300 (1000) or lower	1.00	1.00
3300 to 4900 (1000 – 1500)	0.95	0.97
4900 to 6600 (1500 – 2000)	0.90	0.95
6600 to 8200 (2000 – 2500)	0.85	0.91
8200 to 9800 (2500 – 3000)	0.80	0.88

8.5.2 Storage environment

8.5.2.1 Temporary storage

Store the inverter in an environment that satisfies the requirements listed below.

Item	Specifications	
Storage temperature *1	-25 to +70°C (-13 to +158°F)	Places not subjected to abrupt temperature changes or condensation or freezing
Relative humidity	5 to 95% *2	
Atmosphere	The inverter must not be exposed to dust, direct sunlight, corrosive or flammable gases, oil mist, vapor, water drops or vibration. The atmosphere must contain only a low level of salt. (0.01 mg/cm ² or less per year)	
Atmospheric pressure	86 to 106 kPa (during storage)	
	70 to 106 kPa (during transportation)	

*1 Assuming a comparatively short time storage, e.g., during transportation or the like.

*2 Even if the humidity is within the specified requirements, avoid such places where the inverter will be subjected to sudden changes in temperature that will cause condensation to form.

Precautions for temporary storage

- (1) Do not leave the inverter directly on the floor.
- (2) If the environment does not satisfy the specified requirements, wrap the inverter in an airtight vinyl sheet or the like for storage.
- (3) If the inverter is to be stored in high-humidity environment, put a drying agent (such as silica gel) in the airtight package described in item (2).

8.5.2.2 Long-term storage

The long-term storage method of the inverter varies largely according to the environment of the storage site. General storage methods are described below.

- (1) The storage site must satisfy the requirements specified for temporary storage. However, for storage exceeding three months, the ambient temperature range should be within the range from -10 to 30 °C (+14 to +86 °F). This is to prevent electrolytic capacitors in the inverter from deterioration.
- (2) The package must be airtight to protect the inverter from moisture. Add a drying agent inside the package to maintain the relative humidity inside the package within 70%.
- (3) If the inverter has been installed to the equipment or control board at construction sites where it may be subjected to humidity, dust or dirt, then remove the inverter and store it in a preferable environment.

Precautions for storage over 1 year

If the inverter has not been powered on for a long time, the property of the electrolytic capacitors may deteriorate. Power the inverters on once a year and keep the inverters powering on for 30 to 60 minutes. Do not connect the inverters to motors or run the motor.

8.6 External Dimensions

The diagrams below show external dimensions of FRENIC-Mini according to the type.

8.6.1 Standard models and models available on order (braking resistor built-in type)

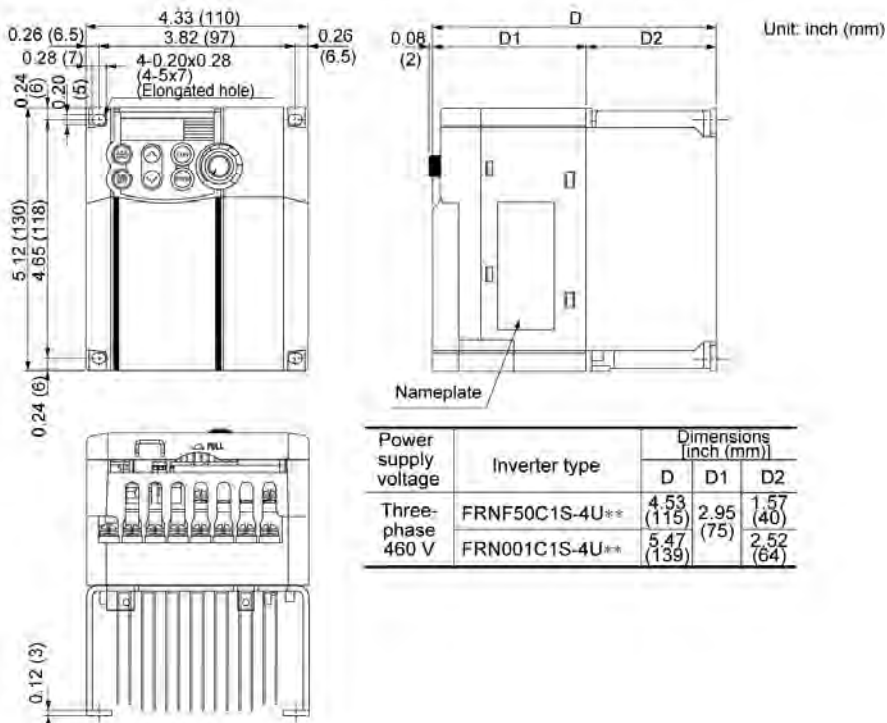
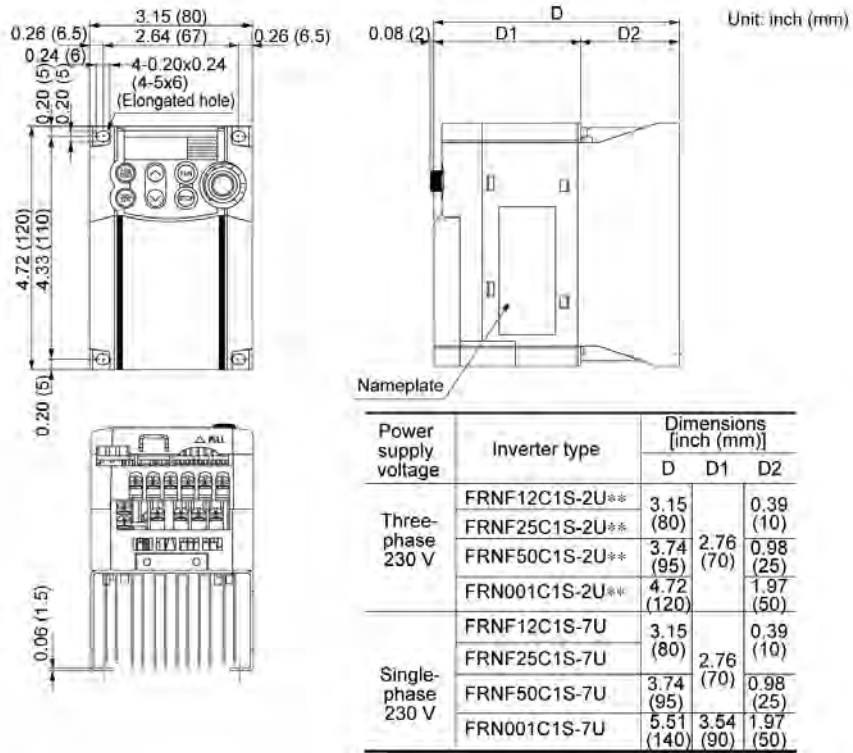

Note 1) Asterisks (**) in the above table replace numbers which denote the following:
21: Braking resistor built-in type, None: Standard.

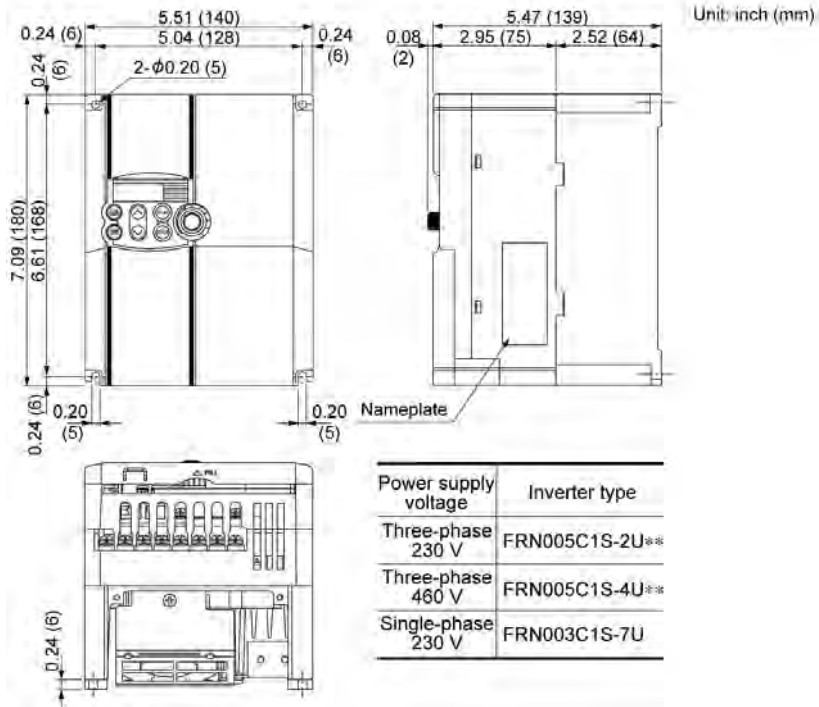
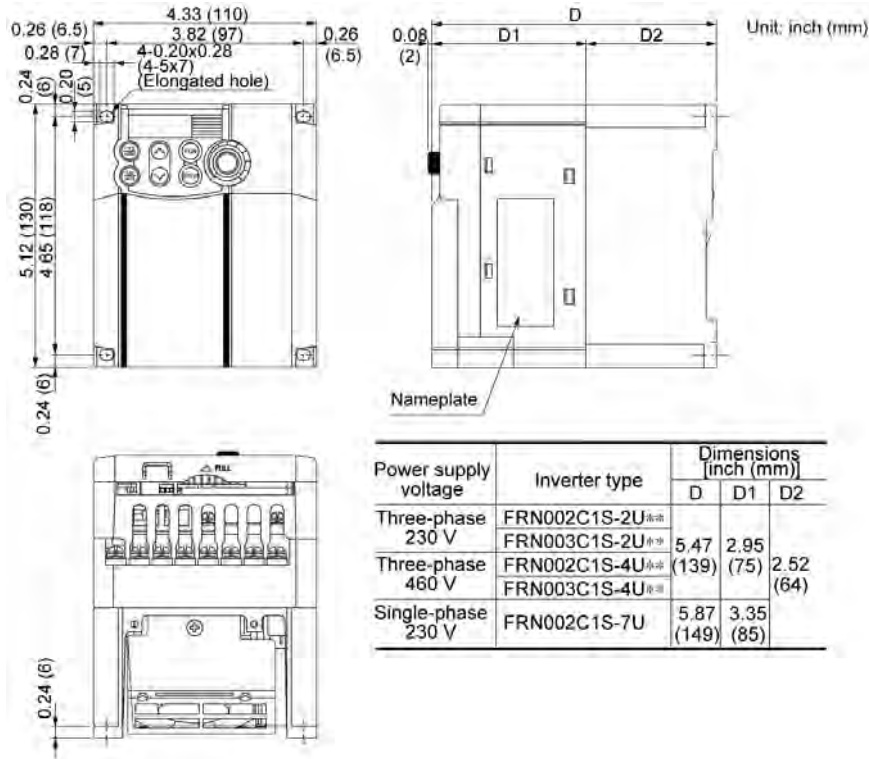

Note 1) Asterisks (**) in the above table replace numbers which denote the following:
 21: Braking resistor built-in type, None: Standard.

8.6.2 Models available on order (EMC filter built-in type)

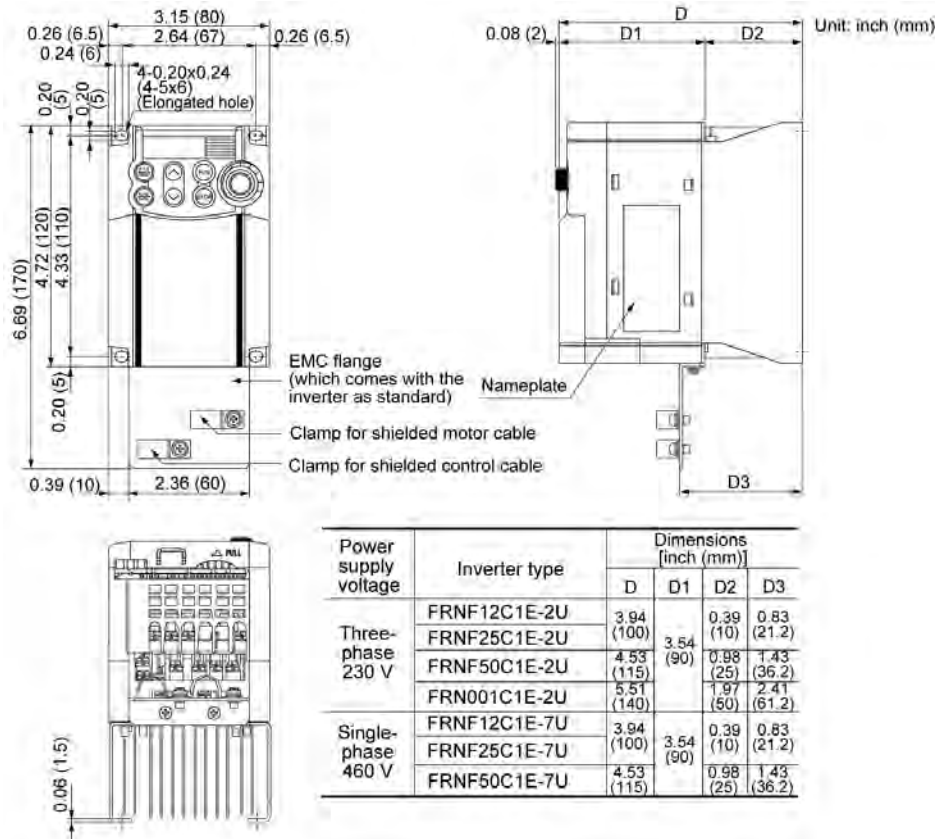

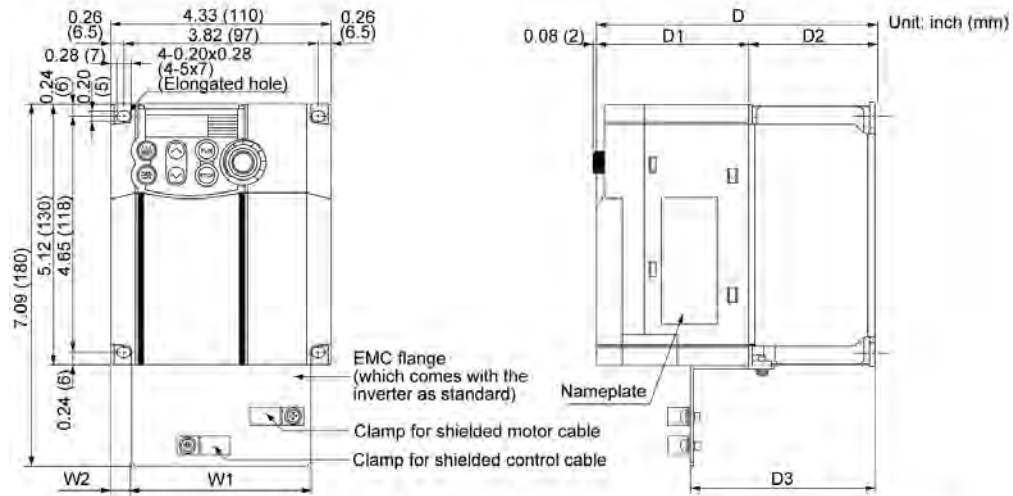

Power supply voltage	Inverter type	Dimensions [inch (mm)]					
		W1	W2	D	D1	D2	D3
Three-phase 460 V	FRNF50C1E-4U	3.50 (89)	0.41 (10.5)	6.22 (158)	4.65 (118)	1.57 (40)	2.42 (61.5)
	FRN001C1E-4U			7.17 (182)		2.52 (64)	3.37 (85.5)
Single-phase 230 V	FRN001C1E-7U	2.36 (60)	0.51 (13.0)	5.47 (139)	3.90 (99)	1.57 (40)	2.17 (55.2)

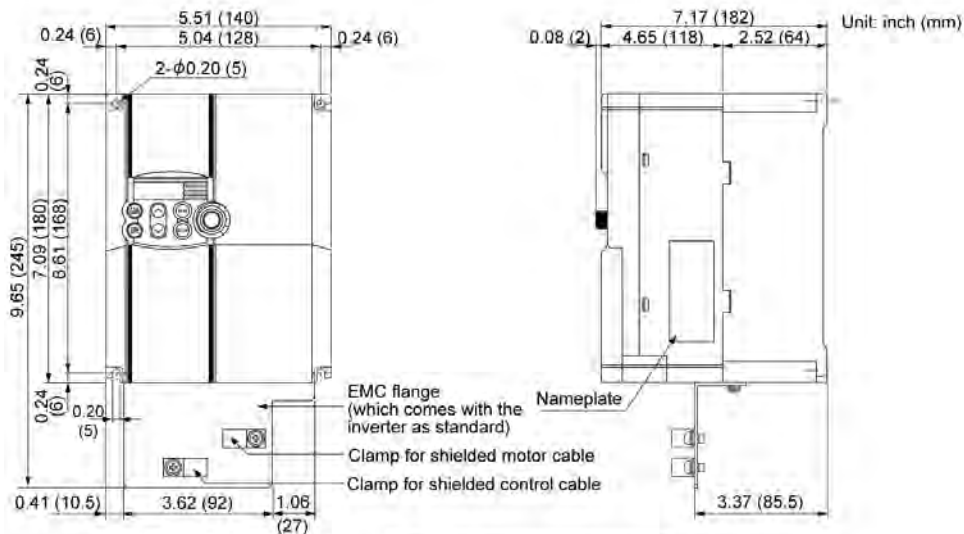
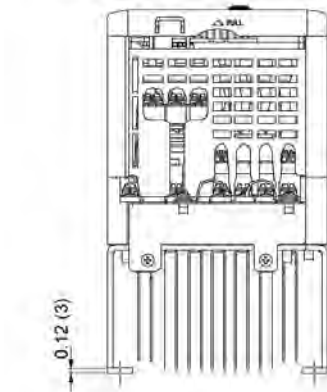

Power supply voltage	Inverter type
Three-phase 230 V	FRN002C1E-2U
	FRN003C1E-2U
	FRN005C1E-2U
Three-phase 460 V	FRN002C1E-4U
	FRN003C1E-4U
	FRN005C1E-4U
Single-phase 230 V	FRN002C1E-7U
	FRN003C1E-7U

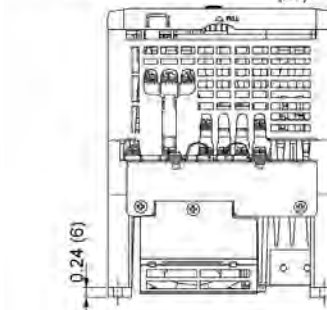

8.7 Connection Diagrams

8.7.1 Keypad operation

The connection diagram below shows an example for a keypad operation with the built-in potentiometer and keys.

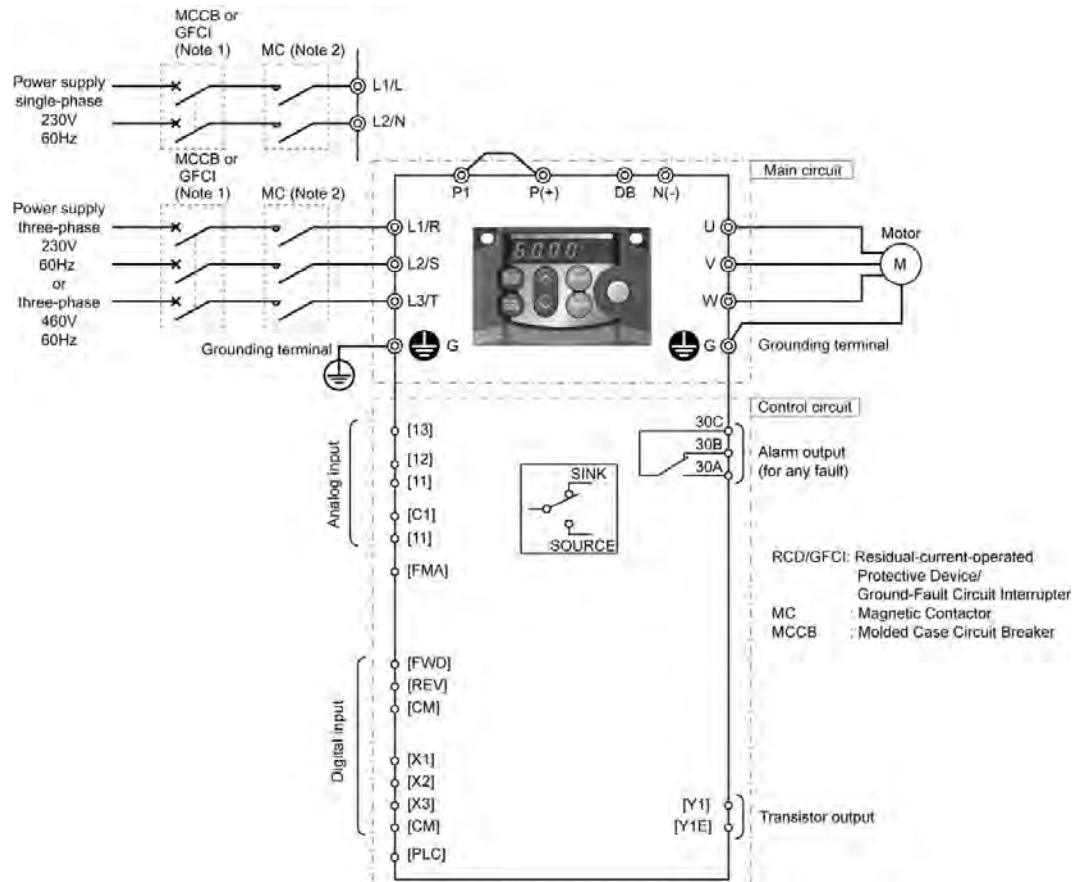

(Note 1) Install a recommended molded case circuit breaker (MCCB) or a residual-current-operated protective device (RCD)/a ground-fault circuit interrupter (GFCI) (with overcurrent protection) in the primary circuit of the inverter to protect wiring. At this time, ensure that the circuit breaker capacity is equivalent to or lower than the recommended capacity.

(Note 2) A magnetic contactor (MC) should, if necessary, be mounted independent of the MCCB or GFCI to cut off the power fed to the inverter. Refer to page 6-7 for details. MCs or solenoids that will be installed close to the inverter require surge absorbers to be connected in parallel to their coils.

8.7.2 Operation by external signal inputs

The basic connection diagram below shows an example for operation by external input signals.

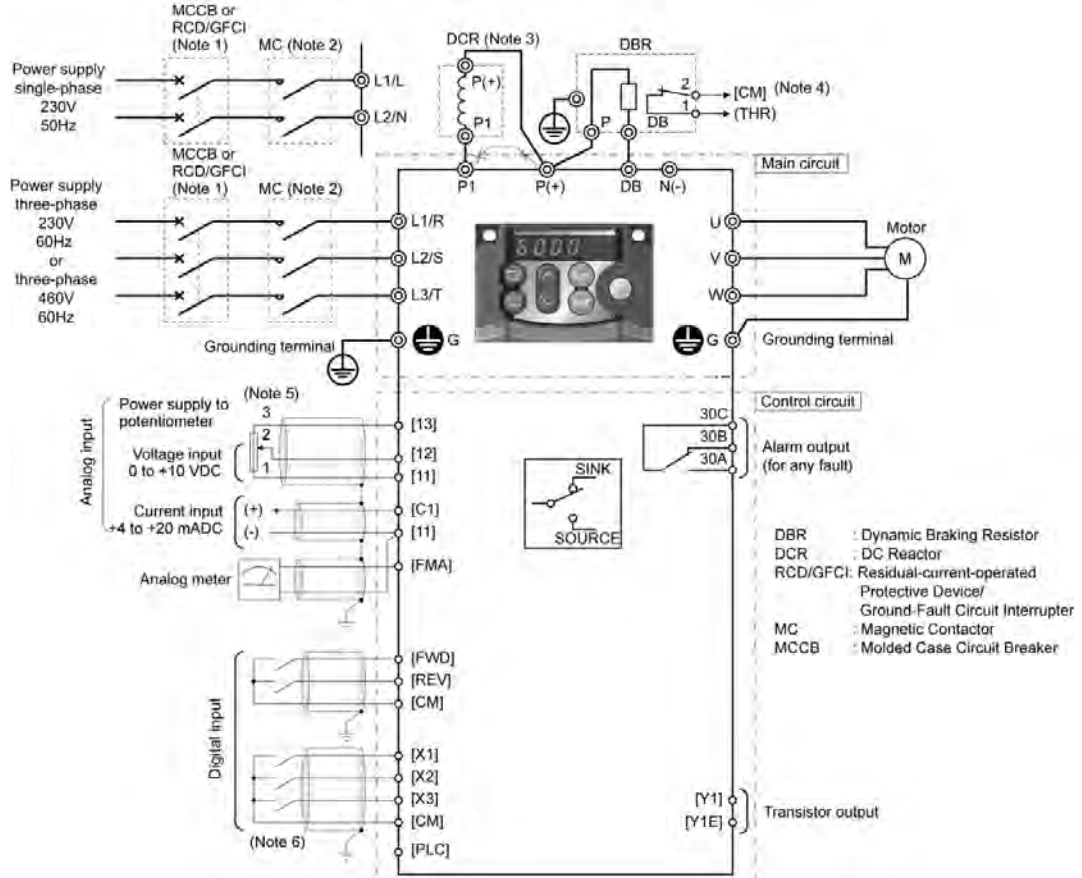

- (Note 1) Install a recommended molded case circuit breaker (MCCB) or a residual-current-operated protective device (RCD)/a ground-fault circuit interrupter (GFCI) (with overcurrent protection) in the primary circuit of the inverter to protect wiring. At this time, ensure that the circuit breaker capacity is equivalent to or lower than the recommended capacity.
- (Note 2) A magnetic contactor (MC) should, if necessary, be mounted independent of the MCCB or GFCI to cut off the power fed to the inverter. Refer to page 6-7 for details. MCs or solenoids that will be installed close to the inverter require surge absorbers to be connected in parallel to their coils.
- (Note 3) When connecting a DC reactor (optional accessory), remove the jumper bar from terminals [P1] and [P+].
- (Note 4) (THR) function can be used by assigning code "9" (Alarm from external equipment) to any of terminals [X1] to [X3], [FWD] or [REV] (function code E01 to E03, E98, or E99). For details, refer to Chapter 9.
- (Note 5) Frequency can be set by connecting a frequency setting device (external potentiometer) between the terminals [11], [12], and [13] instead of inputting voltage signal (0 to +10 VDC or 0 to +5 VDC) between the terminals [12] and [11].
- (Note 6) For the wiring of the control circuit, use shielded or twisted wires. When using shielded wires, connect the shields to earth. To prevent malfunction due to noise, keep the control circuit wiring away from the main circuit wiring as far as possible (recommended: 3.94 in (100 mm) or longer), and never set them in the same wire duct. When crossing the control circuit wiring with the main circuit wiring, set them at right angles.

8.8 Details of Protective Functions



The table below lists the name of the protective functions, description, display of LED monitor, whether alarms output or not at terminals [30A/B/C], and related function codes. If the LED monitor displays an alarm code, remove the cause of activation of the alarm function by referring to FRENIC-Mini Instruction Manual, Chapter 6, "TROUBLESHOOTING."

Name	Description	LED monitor displays	Alarm output [30A/B/C]	Related function code
Overcurrent protection	<ul style="list-style-type: none"> Stops the inverter output to protect the inverter from an overcurrent resulting from overload. Stops the inverter output to protect the inverter from an overcurrent due to a short circuit in the output circuit. Stops the inverter output to protect the inverter from an overcurrent due to a ground fault in the output circuit. This protection is effective only when the inverter starts. If you turn ON the inverter without removing the ground fault, this protection may not work. 	During acceleration	Yes	---
		During deceleration		
		During running at constant speed		
Overvoltage protection	<p>The inverter stops the inverter output upon detecting an overvoltage condition (400 VDC for 3-phase 230 V and 1-phase 230 V series; 800 VDC for 3-phase 460 V series) in the DC link circuit.</p> <p>This protection is not assured if excess AC line voltage is applied inadvertently.</p>	During acceleration	Yes	---
		During deceleration		
		During running at constant speed (Stopped)		
Undervoltage protection	<p>Stops the inverter output when the DC link bus voltage drops below the undervoltage level (200 VDC for 3-phase 230 V and 1-phase 230 V series; 400 VDC for 3-phase 460 V series).</p> <p>However, if data "4 or 5" is selected for F14, no alarm is output even if the DC link bus voltage drops.</p>	LL	Yes (This alarm may not be outputted depending upon the data setting of the function code.)	F14
Input phase loss protection	<p>Detects input phase loss, stopping the inverter output. This function prevents the inverter from undergoing heavy stress that may be caused by input phase loss or inter-phase voltage unbalance and may damage the inverter.</p> <p>If connected load is light or a DC reactor is connected to the inverter, this function will not detect input phase loss if any.</p> <p>In single-phase series of inverters, this function is disabled by factory default.</p>	L 117	Yes	H98
Output phase loss protection	Detects breaks in inverter output wiring at the start of running and during running, stopping the inverter output.	OPL	Yes	H98

"---": Not applicable.

Name		Description	LED monitor displays	Alarm output [30A/B/C]	Related function code
Overheat protection	Inverter	<ul style="list-style-type: none"> Stops the inverter output upon detecting excess heat sink temperature in case of cooling fan failure or overload. 	<i>OH1</i>	Yes	H43
	Braking resistor	<ul style="list-style-type: none"> When the built-in or external braking resistor overheats, discharging and the operation of the inverter are stopped. <p>* It is necessary to set the function code data according to the braking resistor used (built-in or external).</p>	<i>dbH</i>	Yes	F50, F51
Overload protection		Stops the inverter output if the Insulated Gate Bipolar Transistor (IGBT) internal temperature calculated from the output current and cooling fan temperature detection is over the preset value.	<i>OLU</i>	Yes	---
Motor protection	Electronic thermal overload relay	<p>In the following cases, the inverter stops running the motor to protect the motor in accordance with the electronic thermal overload protection.</p> <ul style="list-style-type: none"> Protects general-purpose motors over the entire frequency range. Protects inverter motors over the entire frequency range. <p>* The operation level and thermal time constant can be set.</p>	<i>OL1</i>	Yes	F10 F11, F12
	PTC thermistor	<p>A PTC thermistor input stops the inverter output for motor protection.</p> <p>A PTC thermistor is connected between terminals [C1] and [11], and a 1-kΩ external resistor is connected between terminals [13] and [C1].</p>	<i>OH4</i>	Yes	H26, H27
	Overload early warning	Outputs a preliminary alarm at a preset level before the motor is stopped by the electronic thermal overload protection for the purpose of protecting the motor.	---	---	E34, E35
Stall prevention		<p>Operates when instantaneous overcurrent limiting is active.</p> <p>Instantaneous overcurrent limiting: Operates if the inverter's output current exceeds the instantaneous overcurrent limit level, avoiding tripping of the inverter (during constant speed operation or during acceleration).</p>	---	---	H12
External alarm input		Stops the inverter output with an alarm through the digital input signal (THR).	<i>OH2</i>	Yes	E01 to E03, E98, E99
Alarm relay output (for any fault)		<p>The inverter outputs a relay contact signal when the inverter issues an alarm and stops the inverter output.</p> <p>< Alarm Reset > The alarm stop state is reset by pressing the  key or by the digital input signal (RST).</p> <p>< Saving the alarm history and detailed data > The information on the previous 4 alarms can be saved and displayed.</p>	---	Yes	E20, E27, E01 to E03, E98, E99

"---": Not applicable.

Name	Description		LED monitor displays	Alarm output [30A/B/C]	Related function code
Memory error	The inverter checks memory data after power-on and when the data is written. If a memory error is detected, the inverter stops.		E_{r1}	Yes	---
Remote keypad communications error	The inverter stops by detecting a communication error between the inverter and the remote keypad (option) during operation from the remote keypad.		E_{r2}	Yes (This alarm may not be outputted depending upon the data setting of the function code.)	F02
CPU error	If the inverter detects a CPU error caused by noise or some other factor, the inverter stops.		E_{r3}	Yes	---
Operation Protection	STOP key priority	Pressing the  key on the keypad forces the inverter to decelerate and stop the motor even if the inverter is running by any run commands given via the terminals or communications (link operation). After the motor stops, the inverter issues alarm " E_{r6} ."	E_{r6}	Yes	H96
	Start check function	Inverters prohibit any run operations and displays " E_{r6} " on the LED of keypad if any run command is present when: <ul style="list-style-type: none"> - Powering up - An alarm (the  key turned ON) is released or an alarm reset (RST) is input. - Link command (LE) has switched inverter operation and the run command in the source to be switched is active. 			
RS-485 communication error	On detecting an RS-485 communication error, the inverter displays the alarm code.		E_{r8}	Yes	---
Data save error during undervoltage	If the data could not be saved during activation of the undervoltage protection function, the inverter displays the alarm code.		E_{rF}	Yes	---
Overload prevention control	In the event of overheating of the cooling fan or an overload condition (alarm display: $OH1$ or OLU), the output frequency of the inverter is reduced to keep the inverter from tripping.		---	---	H70

"---": Not applicable.

Chapter 9

FUNCTION CODES

This chapter contains overview lists of seven groups of function codes available for the FRENIC-Mini series of inverters and details of each function code.

Contents

9.1	Function Code Tables.....	9-1
9.2	Details of Function Codes.....	9-12
9.2.1	F codes (Fundamental functions).....	9-12
9.2.2	E codes (Extension terminal functions).....	9-33
9.2.3	C codes (Control functions of frequency).....	9-46
9.2.4	P codes (Motor parameters).....	9-49
9.2.5	H codes (High performance functions).....	9-51
9.2.6	J codes (Application functions).....	9-64
9.2.7	y codes (Link functions).....	9-70







9.1 Function Code Tables

Function codes set up the FRENIC-Mini series of inverters to match your system requirements.

Each function code consists of a 3-letter string. The first letter is an alphabet that identifies its group and the following two letters are numerals that identify each individual code in the group. The function codes are classified into seven groups: Fundamental Functions (F codes), Extension Terminal Functions (E codes), Control Functions of Frequency (C codes), Motor Parameters (P codes), High Performance Functions (H codes), Application Functions (J codes), and Link Functions (y codes).

Changing, validating, and saving function code data when the motor is running

Function codes are indicated by the following based on whether they can be changed or not when the motor is running:

- Function codes marked with N (in the "Change when running" column of the function code tables given below): The data of these codes cannot be changed when the motor is running.
- Function codes marked with Y: The data of these codes can be changed with  and  keys regardless of whether the motor is running or not. Pressing the  key will make the change effective and save it into the inverter's memory.
- Function codes marked with Y*: The difference from function codes marked with Y and these is that if the data of these codes is changed, the change will immediately take effect; however, the change is not saved into the inverter's memory. To save the change, press the  key. If you press the  key to exit the current state without pressing the  key, then the changed data will be discarded and the previous data will take effect for the current inverter operation.

Copying data

Connecting a remote keypad (option) to an inverter via the RS-485 communications card (option) allows copying the data stored in the inverter's memory into the keypad's memory (refer to Menu #7 "Data copying" in Programming mode). With this feature, you can easily transfer the data saved in a source inverter to other destination inverters.

If the specifications of the source inverter and destination inverter differ from each other, some data may not be copied to ensure safe operation of your power system. Whether data will be copied or not is detailed with the following symbols in the "Data copy" column of the function code tables given below.

Y: Will be copied unconditionally.

Y1: Will not be copied if the rated capacity differs from the source inverter.

Y2: Will not be copied if the rated input voltage differs from the source inverter.

N: Will not be copied.

If necessary, manually set the function code data that cannot be copied.

Using negative logic for programmable I/O terminals

The negative logic signaling system can be used for the digital input and output terminals by setting the function codes specifying the properties for those terminals. Negative logic refers to inverted ON/OFF (logical value 1 (true)/0 (false)) state of input or output signal. An ON-active signal (the function takes effect for the ON signal.) in the normal logic system is functionally equivalent to OFF-active signal (the function takes effect for the OFF signal.) in the negative logic system.

To set the negative logic system for an I/O signal terminal, display data of 1000s (by adding 1000 to the data for the normal logic) in the corresponding function code and then press the  key.









For example, if a coast-to-stop command (BX: data = 7) is assigned to any one of digital input terminals X1 to X3 by setting any of function codes E01 through E03, then turning (BX) ON will make the motor coast to a stop. Similarly, if the coast-to-stop command (BX: data = 1007) is assigned, turning (BX) OFF will make the motor coast to a stop.

Limitation of data displayed on the LED monitor

Only four digits can be displayed on the 4-digit LED monitor. If you enter more than 4 digits of data valid for a function code, any digits after the 4th digit of the set data will not be displayed, however they will be processed correctly.

The following tables list the function codes available for the FRENIC-Mini series of inverters.

F codes: Fundamental Functions

Code	Name	Data setting range	Increment	Unit	Change when running	Data copy	Default setting	Refer to:
F00	Data Protection	0: Disable data protection (Function code data can be edited.) 1: Enable data protection (Function code data cannot be edited.)	—	—	Y	N	0	9-12
F01	Frequency Command 1	0: Enable  and  keys on the built-in keypad 1: Enable the voltage input to terminal [12] 2: Enable the current input to terminal [C1] 3: Enable the sum of voltage and current inputs to terminals [12] and [C1] 4: Enable the built-in potentiometer (POT)	—	—	N	Y	4	9-12
F02	Running/Stopping and Rotational Direction	0: Enable  and  keys on the built-in keypad to run and stop motor (The (FWD) or (REV) command should be ON for forward or reverse rotation.) 1: Enable the external signal command (FWD) or (REV) command to run motor 2: Enable  and  keys on the built-in keypad to run/stop motor forward 3: Enable  and  keys on the built-in keypad to run/stop motor reverse	—	—	N	Y	2	9-13
F03	Maximum Frequency	25.0 to 400.0	0.1	Hz	N	Y	60.0	9-14
F04	Base Frequency	25.0 to 400.0	0.1	Hz	N	Y	60.0	9-15
F05	Rated Voltage (at Base Frequency)	0: Output a voltage in line with variance in input voltage 80 to 240: Output a voltage AVR-controlled *2 (Note 1) 160 to 500: Output a voltage AVR-controlled *2 (Note 2)	1	V	N	Y2	230 460	9-15
F07	Acceleration Time 1	0.00 to 3600 Note: Acceleration time is ignored at 0.00. (External gradual acceleration pattern)	0.01	s	Y	Y	6.00	9-17
F08	Deceleration Time 1	0.00 to 3600 Note: Deceleration time is ignored at 0.00. (External gradual deceleration pattern)	0.01	s	Y	Y	6.00	9-17
F09	Torque Boost	0.0 to 20.0 (The set voltage at base frequency for F05 is 100%.) Note: This setting is effective for auto torque boost/auto energy saving operations specified by function code F37 (= 0, 1, 3, or 4).	0.1	%	Y	Y	Fuji's *1 standard torque boost	9-17
F10	Electronic Thermal Overload for Motor Protection (Select motor characteristics)	1: For general-purpose motors with built-in self-cooling fan 2: For inverter-driven motors or high-speed motors with forced-ventilation fan	—	—	Y	Y	1	9-18
F11	(Overload detection level)	0.00 (Disable) 1 to 135% of rated current (allowable continuous load current) of the inverter	0.01	A	Y	Y1 Y2	Nominal *1 rated current of Fuji standard motor	

*1 "Fuji's standard torque boost," "Nominal rated current of Fuji standard motor," and "Nominal rated capacity of Fuji standard motor" differ depending upon the rated input voltage and rated capacity. Refer to Table 9.1 "Fuji Standard Motor Parameters" on page 9-11.

*2 AVR: Automatic Voltage Regulator

(Note 1) For the three-phase 230 V and single-phase 230 V

(Note 2) For the three-phase 460 V

Code	Name	Data setting range	Increment	Unit	Change when running	Data copy	Default setting	Refer to:
F12	(Thermal time constant)	0.5 to 75.0	0.1	min	Y	Y	5.0	9-18
F14	Restart Mode after Instantaneous Power Failure	0: Disable (Trip immediately without restart) 1: Disable (Trip without restart after recovery of power) 4: Enable (Restart at the frequency at which the power failure occurred, for general load) 5: Enable (Restart at the start frequency, for low-inertia load)	—	—	Y	Y	0	9-19
F15	Frequency Limiter (High)	0.0 to 400.0	0.1	Hz	Y	Y	70.0	9-21
F16	(Low)	0.0 to 400.0	0.1	Hz	Y	Y	0.0	
F18	Bias (for frequency command 1)	-100.00 to 100.00	0.01	%	Y*	Y	0.00	9-22
F20	DC Braking (Start frequency)	0.0 to 60.0	0.1	Hz	Y	Y	0.0	9-23
F21	(Braking level)	0 to 100 (Rated output current of the inverter interpreted as 100%.)	1	%	Y	Y	0	
F22	(Braking time)	0.00 (Disable), 0.01 to 30.00	0.01	s	Y	Y	0.00	
F23	Start Frequency	0.1 to 60.0	0.1	Hz	Y	Y	1.0	9-25
F25	Stop Frequency	0.1 to 60.0	0.1	Hz	Y	Y	0.2	9-25
F26	Motor Sound (Carrier frequency)	0.75 to 15	1	kHz	Y	Y	2	9-25
F27	(Tone)	0: Level 0 1: Level 1 2: Level 2 3: Level 3	—	—	Y	Y	0	9-26
F30	Terminal [FMA] (Gain to output voltage)	0 to 200 If 100 is set, +10 VDC will be output from [FMA] at full scale.	1	%	Y*	Y	100	9-26
F31	Analog Output Signal Selection for [FMA] (Monitor object)	0: Output frequency 1 (before slip compensation) Maximum output frequency at full scale 1: Output frequency 2 (after slip compensation) Maximum output frequency at full scale 2: Output current Two times the inverter's rated output current at full scale 3: Output voltage 250 V (500 V) at full scale 6: Input power Two times the inverter's rated output capacity at full scale 7: PID feedback value Feedback value is 100% at full scale 9: DC link bus voltage 500 VDC (for 230 V), 1000 VDC (for 460 V) at full scale 14: Test analog output (+) voltage If F30 = 100, +10 VDC at full scale	—	—	Y	Y	0	9-26

Code	Name	Data setting range	Increment	Unit	Change when running	Data copy	Default setting	Refer to:
F37	Load Selection/ Auto Torque Boost/ Auto Energy Saving Operation	0: Variable torque load 1: Constant torque load 2: Auto-torque boost 3: Auto-energy saving operation (Variable torque load during acceleration and deceleration) 4: Auto-energy saving operation (Constant torque load during acceleration and deceleration) 5: Auto-energy saving operation (Auto-torque boost during acceleration and deceleration)	—	—	N	Y	1	9-27
F43	Current Limiter (Operation condition)	0: Disable 1: In constant speed (Disable during acceleration and deceleration) 2: At acceleration and in constant speed (Disable during deceleration)	—	—	Y	Y	2	9-28
F44	(Limiting level)	20 to 200 (The data is interpreted as the rated output current of the inverter for 100%.)	1	%	Y	Y	180	
F50	Electronic Thermal Overload Relay (for braking resistor) (Discharging capability)	0: (To be set for braking resistor built-in type) 1 to 900 999: (Disable)	1	kWs	Y	Y	999/0 (Note)	9-28
F51	(Allowable loss)	0.000: Applied for built-in braking resistor, 0.001 to 50.000	0.001	kW	Y	Y	0.000	

(Note) The default setting of function code F50 is 999 for standard models, and 0 for braking resistor built-in type.

E codes: Extension Terminal Functions



Code	Name	Data setting range	Increment	Unit	Change when running	Data copy	Default setting	Refer to:
E01	Terminal Command Assignment to: [X1]	To assign a negative logic input to a terminal, set the value of 1000s shown in () below to the function code. 0: (1000) Select multistep frequency (0 to 1 steps) (SS1) 1: (1001) Select multistep frequency (0 to 3 steps) (SS2) 2: (1002) Select multistep frequency (0 to 7 steps) (SS4) 4: (1004) Select ACC/DEC time (2 steps) (RT1) 6: (1006) Enable 3-wire operation (HLD) 7: (1007) Coast to a stop (BX) 8: (1008) Reset alarm (RST) 9: (1009) Enable external alarm trip (THR) 10: (1010) Ready for jogging (JOG) 11: (1011) Switch set frequency 2/1 (Hz2/Hz1) 19: (1019) Enable write from keypad (WE-KP) 20: (1020) Cancel PID control (Hz/PID) 21: (1021) Switch normal/inverse operation (IVS) 24: (1024) Enable communications link (RS-485 communication, option) (LE) 33: (1033) Reset PID integral and differential components (PID-RST) 34: (1034) Hold PID integral component (PID-HLD)	—	—	N	Y	0	9-33
E02	[X2]		—	—	N	Y	7	
E03	[X3]		—	—	N	Y	8	

Code	Name	Data setting range	Increment	Unit	Change when running	Data copy	Default setting	Refer to:
E10	Acceleration Time 2	0.00 to 3600	0.01	s	Y	Y	6.00	9-17 9-38
E11	Deceleration Time 2	0.00 to 3600	0.01	s	Y	Y	6.00	9-17 9-38
E20	Status Signal Assignment to: [Y1] [30A/B/C] (Mechanical relay contacts)	To assign a negative logic output to a terminal, set the value of 1000s shown in () on the table below to the function code. (OFF if short-circuited) 0: (1000) Inverter running (RUN) 1: (1001) Frequency equivalence signal (FAR) 2: (1002) Frequency level detection (FDT) 3: (1003) Undervoltage detection signal (LU) 5: (1005) Torque limiting (Current limiting) (IOL) 6: (1006) Auto-restart after recovery from instantaneous power failure (IPF) 7: (1007) Early warning for motor overload (OL) 26: (1026) Retry in operation (TRY) 30: (1030) Lifetime alarm (LIFE) 35: (1035) Inverter running (RUN2) 36: (1036) Overload prevention control (OLP) 37: (1037) Current detection (ID) 41: (1041) Low level current detection (IDL) 99: (1099) Alarm relay output (for any alarm) (ALM)	—	—	N	Y	0	9-39
E27			—	—	N	Y	99	
E31	Frequency Detection (FDT) (Detection level)	0.0 to 400.0	0.1	Hz	Y	Y	60.0	9-42
E34	Overload Early Warning/Current Detection/Low Current Detection (Level)	0 (Disable) Current value of 1 to 200% of the rated inverter current	0.01	A	Y	Y1 Y2	Nominal ^{*1} rated current of Fuji standard motor	9-42
E35	Current Detection/Low Current Detection (Timer)	0.01 to 600.00	0.01	s	Y	Y	10.00	9-42
E39	Coefficient for Constant Feeding Rate Time	0.000 to 9.999	0.001	—	Y	Y	0.000	9-43
E40	PID Display Coefficient A	-999 to 0.00 to 999	0.01	—	Y	Y	100	9-43
E41	PID Display Coefficient B	-999 to 0.00 to 999	0.01	—	Y	Y	0.00	9-43
E43	Monitor Item Selection	0: Speed monitor (Select by E48.) 3: Output current 4: Output voltage 9: Input power 10: PID final command value 12: PID feedback value 13: Timer value (Timer operation)	—	—	Y	Y	0	9-43
E45	(Note)							
E46								
E47								
E48	LED Monitor (Speed monitor item)	0: Output frequency before slip compensation 1: Output frequency after slip compensation 2: Set frequency 4: Load shaft speed in rpm 5: Line speed in m/min 6: Constant feeding rate time	—	—	Y	Y	0	9-44

(Note) Function codes E45 to E47 appear on the LED monitor; however, the FRENIC-Mini series of inverters does not recognize these codes.
^{*1} "Fuji's standard torque boost," "Nominal rated current of Fuji standard motor," and "Nominal rated capacity of Fuji standard motor" differ depending upon the rated input voltage and rated capacity. Refer to Table 9.1 "Fuji Standard Motor Parameters" on page 9-11.

Code	Name	Data setting range	Increment	Unit	Change when running	Data copy	Default setting	Refer to:
E50	Coefficient for Speed Indication	0.01 to 200.00	0.01	—	Y	Y	30.00	9-43 9-44
E52	Menu Display Mode for Keypad	0: Function code data setting mode 1: Function code data check mode 2: Full-menu mode	—	—	Y	Y	0	9-44
E60	Built-in Potentiometer (Function selection)	0: None 1: Auxiliary frequency command 1 2: Auxiliary frequency command 2 3: PID process command 1	—	—	N	Y	0	9-44
E61	Analog Input Signal Definition for: [12] [C1]	0: None 1: Auxiliary frequency command 1 2: Auxiliary frequency command 2 3: PID process command 1	—	—	N	Y	0	9-44
E62		5: PID feedback value	—	—	N	Y	0	9-44
E98	Terminal Command Assignment to: [FWD]	To assign a negative logic input to a terminal, set the value of 1000s shown in () in the table below to the function code.	—	—	N	Y	98	9-33 9-45
E99	[REV]	0: (1000) Select multistep frequency (0 to 1 steps) (SS1) 1: (1001) Select multistep frequency (0 to 3 steps) (SS2) 2: (1002) Select multistep frequency (0 to 7 steps) (SS4) 4: (1004) Select ACC/DEC time (2 steps) (RT1) 6: (1006) Enable 3-wire operation (HLD) 7: (1007) Coast to a stop (BX) 8: (1008) Reset alarm (RST) 9: (1009) Enable external alarm trip (THR) 10: (1010) Ready for jogging (JOG) 11: (1011) Switch set frequency 2/1 (Hz2/Hz1) 19: (1019) Enable write from keypad (WE-KP) 20: (1020) Cancel PID control (Hz/PID) 21: (1021) Switch normal/inverse operation (IVS) 24: (1024) Enable communications link (RS-485 communication, option) (LE) 33: (1033) Reset PID integral and differential components (PID-RST) 34: (1034) Hold PID integral component (PID-HLD) 98: Run forward (FWD) 99: Run reverse (REV)	—	—	N	Y	99	

C codes: Control Functions of Frequency

Code	Name	Data setting range	Increment	Unit	Change when running	Data copy	Default setting	Refer to:
C01	Jump Frequency 1	0.0 to 400.0	0.1	Hz	Y	Y	0.0	9-46
C02	2					Y	0.0	
C03	3					Y	0.0	
C04	Jump Frequency Band	0.0 to 30.0	0.1	Hz	Y	Y	3.0	9-46
C05	Multistep Frequency Settings 1	0.00 to 400.00	0.01	Hz	Y	Y	0.00	9-46
C06	2					Y	0.00	
C07	3					Y	0.00	
C08	4					Y	0.00	
C09	5					Y	0.00	
C10	6					Y	0.00	
C11	7					Y	0.00	
C20	Jogging Frequency	0.00 to 400.00	0.01	Hz	Y	Y	0.00	9-47
C21	Timer Operation	0: Disable timer operation 1: Enable timer operation	—	—	N	Y	0	9-47
C30	Frequency Command 2	0: Enable  and  keys on the built-in keypad 1: Enable the voltage input to terminal [12] 2: Enable the current input to terminal [C1] 3: Enable the sum of voltage and current inputs to terminals [12] and [C1] 4: Enable the built-in potentiometer (POT)	—	—	N	Y	2	9-12 9-48
C32	Analog Input Adjustment (Gain for terminal input [12])	0.00 to 200.00	0.01	%	Y*	Y	100.0	9-22 9-48
C33	(Filter)	0.00 to 5.00	0.01	s	Y	Y	0.05	9-48
C34	(Gain reference point)	0.00 to 100.00	0.01	%	Y*	Y	100.0	9-22 9-48
C37	Analog Input Adjustment (Gain for terminal input [C1])	0.00 to 200.00	0.01	%	Y*	Y	100.0	9-22 9-48
C38	(Filter)	0.00 to 5.00	0.01	s	Y	Y	0.05	9-48
C39	(Gain reference point)	0.00 to 100.00	0.01	%	Y*	Y	100.0	9-22 9-48
C50	Bias (Frequency command 1) (Bias reference point)	0.00 to 100.00	0.01	%	Y*	Y	0.00	9-22 9-48
C51	Bias (PID command 1) (Bias value)	-100.00 to 100.00	0.01	%	Y*	Y	0.00	9-48
C52	(Bias reference point)	0.00 to 100.00	0.01	%	Y*	Y	0.00	9-48

Code	Name	Data setting range	Increment	Unit	Change when running	Data copy	Default setting	Refer to:
H50	Non-linear V/f Pattern (Frequency) (Voltage)	0.0 (Cancel), 0.1 to 400.0	0.1	Hz	N	Y	0.0	9-15 9-60
H51		0 to 240: Output voltage AVR-controlled for 200 V class motors 0 to 500: Output voltage AVR-controlled for 400 V class motors	1	V	N	Y2	230 460	
H54	ACC/DEC Time (Jogging operation)	0.00 to 3600	0.01	s	Y	Y	6.00	9-60
H64	Low Limiter (Min. freq. when limiter is activated)	0.0 (Depends on F16 : Freq. limiter (low)), 0.1 to 60.0	0.1	Hz	Y	Y	2.0	9-60
H69	Automatic Deceleration (Regenerative energy suppressing)	0: Disable 1: Enable	—	—	Y	Y	0	9-60
H70	Overload Prevention Control (Frequency drop rate)	0.00 (Equivalent to deceleration time), 0.01 to 100.00, 999 (Cancel)	0.01	Hz/s	Y	Y	999	9-61
H71	(Note 1)							
H80	Gain for Suppression of Output Current Fluctuation	0.00 to 0.20	0.01	—	Y	Y	0.20	9-61
H89	Motor overload memory retention (Note 3)	0: Inactive When power up the drive, Motor overload data is reset. 1: Active. When power is down, the drive stores Motor overload data and use this data at next power up.	—	—	Y	Y	1	5-49
H95	DC Braking (Note 2) (Braking mode)	0: Slow response 1: Quick response	—	—	Y	Y	0	9-61
H96	STOP Key Priority/ Start Check Function	STOP key priority Start check function 0: Invalid Invalid 1: Valid Invalid 2: Invalid Valid 3: Valid Valid	—	—	Y	Y	3	9-62
H97	Clear Alarm Data	Returns to zero after clearing alarm data (if H97 = 1).	—	—	Y	N	0	9-62
H98	Protection/ Maintenance Functions	opL Lin ADFCF 0: Disable Disable Disable 1: Disable Disable Enable 2: Disable Enable Disable 3: Disable Enable Enable 4: Enable Disable Disable 5: Enable Disable Enable 6: Enable Enable Disable 7: Enable Enable Enable opL: Output Phase Loss Protection Lin: Input Phase Loss Protection ADFCF: Automatic DEC Function for Carrier Frequency Note: For single-phase power input inverters, Lin is always invalid regardless of H98 setting.	—	—	Y	Y	3	9-25 9-63

(Note 1) Function code H71 appears on the LED monitor; however, the FRENIC-Mini series of inverters does not recognize this code.
 (Note 2) Function code H95 is valid on the inverters with ROM versions of C1S11000 or higher. (The lowest four digits of the ROM version can be displayed on the LED monitor. For details, refer to Chapter 3, Section 3.3.5 "Reading maintenance information."
 (Note 3) Function code H89 is valid on inverters with ROM version C1S11300 or later.

J codes: Application Functions

Code	Name	Data setting range	Increment	Unit	Change when running	Data copy	Default setting	Refer to:
J01	PID Control (Selection)	0: Disable 1: Process control use (Normal action) 2: Process control use (Inverse action)	—	—	N	Y	0	9-64
J02	(Remote process command)	0: Keypad 1: PID process command 1 (Data settings of E60, E61 and E62 are also required.) 4: Communication	—	—	N	Y	0	
J03	P (Gain)	0.000 to 10.00	0.001	Times	Y	Y	0.100	
J04	I (Integration time)	0.0 to 3600.0	0.1	s	Y	Y	0.0	
J05	D (Differentiation time)	0.00 to 600.00	0.01	s	Y	Y	0.00	
J06	(Feedback filter)	0.0 to 900.0	0.1	s	Y	Y	0.5	

y codes: Link Functions

Code	Name	Data setting range	Increment	Unit	Change when running	Data copy	Default setting	Refer to:
y01	Link Functions for RS-485 Communication (Station address)	1 to 255	1	—	N	Y	1	9-70
y02	(Mode selection on no response error)	0: Immediate trip and alarm <i>Er 8</i> 1: Trip and alarm <i>Er 8</i> after running for the period of the timer set by y03 2: Retry during the period of the timer set by y03. If retry fails, trip and alarm <i>Er 8</i> 3: Continue to run	—	—	Y	Y	0	
y03	(Timer)	0.0 to 60.0	0.1	s	Y	Y	2.0	
y04	(Baud rate)	0: 2400 bps 1: 4800 bps 2: 9600 bps 3: 19200 bps	—	—	Y	Y	3	
y05	(Data length)	0: 8 bits 1: 7 bits	—	—	Y	Y	0	
y06	(Parity check)	0: None 1: Even parity 2: Odd parity	—	—	Y	Y	0	
y07	(Stop bits)	0: 2 bits 1: 1 bit	—	—	Y	Y	0	
y08	(No response error detection time)	0 (No detection), 1 to 60	1	s	Y	Y	0	
y09	(Response interval)	0.00 to 1.00	0.01	s	Y	Y	0.01	
y10	(Protocol selection)	0: Modbus RTU protocol 1: SX protocol (Loader protocol) 2: Fuji general-purpose inverter protocol	—	—	Y	Y	0	
y99	Link Function for Supporting Data Input	Frequency command source Run command source 0: by H30 by H30 1: via RS-485 communication (option) by H30 2: by H30 via RS-485 communication (option) 3: via RS-485 communication (option) via RS-485 communication (option)	—	—	Y	N	0	9-73

* The table below lists the factory settings of "Fuji's standard torque boost," "Nominal rated current of Fuji standard motor," and "Nominal rated capacity of Fuji standard motor" in the "Default setting" column of the above tables.

Table 9.1 Fuji Standard Motor Parameters

Power supply voltage	Applicable motor rating (HP)	Inverter type	Fuji's standard torque boost (%)	Nominal rated current of Fuji standard motor (A)			Nominal rated capacity of Fuji standard motor (kW)
			Function code F09	Function codes F11, E34 and P03			Function code P02
				Shipping destination (version)			
				Asia	EU	Japan	
Three-phase 230 V	1/8	FRNF12C1■-2U	8.4	0.62	0.68	0.61	0.1
	1/4	FRNF25C1■-2U	8.4	1.18	1.30	1.16	0.2
	1/2	FRNF50C1■-2U	7.1	2.10	2.30	2.13	0.4
	1	FRN001C1■-2U	6.8	3.29	3.60	3.36	0.75
	2	FRN002C1■-2U**	6.8	5.55	6.10	5.87	1.5
	3	FRN003C1■-2U**	6.8	8.39	9.20	8.80	2.2
Three-phase 460 V	5	FRN005C1■-2U**	5.5	13.67	15.00	14.38	3.7
	1/2	FRNF50C1■-4U	7.1	1.09	1.15	1.07	0.4
	1	FRN001C1■-4U	6.8	1.71	1.80	1.68	0.75
	2	FRN002C1■-4U**	6.8	3.04	3.05	2.94	1.5
	3	FRN003C1■-4U**	6.8	4.54	4.60	4.40	2.2
Single-phase 230 V	5	FRN005C1■-4U**	5.5	7.43	7.50	7.20	3.7
	1/8	FRNF12C1■-7U	8.4	0.62	0.68	0.61	0.1
	1/4	FRNF25C1■-7U	8.4	1.18	1.30	1.16	0.2
	1/2	FRNF50C1■-7U	7.1	2.10	2.30	2.13	0.4
	1	FRN001C1■-7U	6.8	3.29	3.60	3.36	0.75
	2	FRN002C1■-7U	6.8	5.55	6.10	5.87	1.5
	3	FRN003C1■-7U	6.8	8.39	9.20	8.80	2.2

Note 1) A box (■) in the above table replaces S or E depending on the enclosure.

2) Asterisks (**) in the above table denote the following:

21: Braking resistor built-in type

(Available for 2 HP or above, three-phase 230 V and 460 V models)

None: Standard



9.2 Details of Function Codes

This section provides a detailed description of the function codes available for the FRENIC-Mini series of inverters. In each code group, its function codes are arranged in an ascending order of the identifying numbers for ease of access. Note that function codes closely related each other for the implementation of an inverter's operation are detailed in the description of the function code having the youngest identifying number. Those related function codes are indicated in the title bar as shown below.





F01	Frequency Command 1	Refer to C30.
------------	----------------------------	----------------------

9.2.1 F codes (Fundamental functions)

F00	Data Protection
------------	------------------------



Specifies whether function code data is to be protected from being accidentally changed by keypad operation. If data protection is enabled (F00 = 1),  /  key operation to change data is disabled so that no function code data, except F00 data, can be changed from the keypad.

 Even if F00 = 1, function code data can still be changed using the communications facility.

Data for F00	Function	Setting procedure
0	Disable data protection.	Press  and  keys or  and  keys simultaneously to change data from 1 to 0 or from 0 to 1, respectively. Press the  key to save the change.
1	Enable data protection.	

F01	Frequency Command 1	Refer to C30.
------------	----------------------------	----------------------

Selects the devices to set the set frequency 1 for driving the motor.

Data for F01	Function
0	Enable  and  keys on the built-in keypad. (Refer to Chapter 3 "OPERATION USING THE KEYPAD.")
1	Enable the voltage input to terminal [12] (0 to 10 VDC, maximum output frequency obtained at 10 VDC).
2	Enable the current input to terminal [C1] (4 to 20 mA, maximum output frequency obtained at 20 mA).
3	Enable the sum of voltage and current inputs to terminals [12] and [C1]. See the two items listed above for the setting range and maximum frequencies. Note: If the sum exceeds the maximum output frequency, the maximum output frequency will apply.
4	Enable the built-in potentiometer (POT). (Maximum frequency obtained at full scale of the POT)

 There are other frequency setting means (such as the communications facility, multistep frequency and etc.) with higher priority than that of F01. Refer to Chapter 4, Section 4.2 "Drive Frequency Command Generator" for more details.



- For frequency settings by terminals [12] (voltage) and [C1] (current) and by the built-in potentiometer, setting the gain and bias changes the relationship between those frequency settings and the drive frequency to enable matching your system requirements. Refer to function code F18 for details.
- For the inputs to terminals [12] (voltage) and [C1] (current), low-pass filters can be enabled. Refer to function codes C33 and C38 for details.

In addition to "F01 Frequency command 1," "C30 Frequency command 2" is also available. To switch them, use the terminal command (Hz2/Hz1). For details of the (Hz2/Hz1), refer to "E01 to E03: Command Assignment to Terminals [X1] to [X3]."

F02**Running/Stopping and Rotational Direction**

Selects a source issuing a run command--keypad or external control signal input.







- If F02 = 0, 2, or 3, the inverter can run the motor by and keys on the built-in keypad. The motor rotational direction can be specified in two ways, either by control signal input (F02 = 0) or by use of prefixed forward or reverse rotation (F02 = 2 or 3).

When F02 = 0, to specify the motor rotational direction by control signal input, assign the commands (FWD) and (REV) to terminals [FWD] and [REV], respectively. Turn on the (FWD) or (REV) for the forward or reverse direction, respectively, and then press the key to run the motor.

- If F02 = 1, the inverter can run the motor by control signal inputs. To specify the motor rotational direction, assign the commands (FWD) and (REV) to terminals [FWD] and [REV], respectively. Turn on the (FWD) or (REV) for the forward or reverse direction, respectively. If both of (FWD) and (REV) are turned on simultaneously, the inverter immediately decelerates to stop the motor.

Data for F02	Function
0	Enable and keys on the built-in keypad to run and stop the motor. (The (FWD) or (REV) command should be ON for forward or reverse rotation beforehand.)
1	Enable the (FWD) or (REV) command to run the motor. To turn on the (FWD) command, short-circuit terminals [FWD] and [CM]; to turn on the (REV) command, short-circuit terminals [REV] and [CM].
2	Enable and keys on the built-in keypad to run and stop the motor in the forward direction.
3	Enable and keys on the built-in keypad to run and stop the motor in the reverse direction.

The table below lists the operational relationship between function code F02 (Running/stopping and rotational direction), the  key operation, and control signal inputs to terminals [FWD] and [REV], which determines the rotational direction.

Data for F02	Key on the built-in keypad	Control Signal Inputs to Terminals [FWD] and [REV]		Motor rotational direction
		Function code E98 (FWD) command	Function code E99 (REV) command	
0	 key	OFF	OFF	Stop
		ON	OFF	Forward
		OFF	ON	Reverse
		ON	ON	Stop
	 key	OFF	OFF	Stop
		ON	OFF	
		OFF	ON	
		ON	ON	
1	Ignored.	OFF	OFF	Stop
		ON	OFF	Forward
		OFF	ON	Reverse
		ON	ON	Stop
2 (forward/fixed)	 key	Ignored.		Forward
	 key	Ignored.		Stop
3 (reverse/fixed)	 key	Ignored.		Reverse
	 key	Ignored.		Stop

F03

Maximum Frequency

Sets the maximum frequency to drive the motor. Setting the frequency out of the range rated for the equipment driven by the inverter may cause damage or a dangerous situation. Set a maximum frequency appropriate for the equipment.

- Data setting range: 25.0 to 400.0 (Hz)

 In general, internal impedance of high-speed motors is low. This may cause unstable motor/inverter behavior. When this kind of motor is used, it is recommended that the carrier frequency (F26) be set to 15 kHz and the motor/inverter operation be checked.

 Keep the ratio between base frequency (F04) and maximum frequency to 1:8 or less.

F04	Base Frequency	Refer to H50.
F05	Rated Voltage (at Base Frequency)	Refer to H51.

These function codes set the base frequency and the voltage at the base frequency essentially required for running the motor properly. If combined with the related function codes H50 and H51, these function codes may set data needed to drive the motor along the non-linear V/f pattern.

The following description includes setting-up required for the non-linear V/f pattern.

■ **Base frequency (F04)**

Set the rated frequency printed on the nameplate located on the motor.

- Data setting range: 25.0 to 400.0 (Hz)

■ **Rated voltage (at base frequency) (F05)**

Set 0 or the rated voltage printed on the nameplate labeled on the motor.

- If 0 is set, the rated voltage at base frequency is determined by the power source of the inverter. The output voltage will vary in line with any variance in input voltage.
- If the data is set to anything other than 0, the inverter automatically keeps the output voltage constant in line with the setting. When any of the automatic torque boost settings, automatic energy saving or slip compensation is active, the voltage settings should be equal to the rating of the motor.



If F05 is set to match the rated voltage of the motor, the motor efficiency will be improved better than that it is set to 0. Therefore, when brakes are applied to the motor, energy loss decreases and the motor regenerates larger braking energy, which can easily activate the overvoltage protection function. Note that the allowable power consumption capacity of the inverter for braking energy is limited by the specifications. If the overvoltage protection function is activated, it may be necessary to increase deceleration time or use an external braking resistor.

Data for F05	Function
0	Output voltage in line with variance in input voltage. (The AVR is disabled. AVR: Automatic Voltage Regulator)
80 to 240 (V)	Output AVR-controlled voltage for 230 V class motors.
160 to 500 (V)	Output AVR-controlled voltage for 460 V class motors.

■ **Non-linear V/f pattern for frequency (H50)**

Sets the non-linear V/f pattern for frequency component.

- Data setting range: 0.0 to 400.0 Hz
(Setting 0.0 to H50 disables the non-linear V/f pattern operation.)

■ **Non-linear V/f pattern for voltage (H51)**

Sets the non-linear V/f pattern for voltage component.

Data for H51	Function
0 to 240 (V)	Output the voltage AVR-controlled for 230 V class motors.
0 to 500 (V)	Output the voltage AVR-controlled for 460 V class motors.

If the voltage at base frequency (F05) is set to 0, the data settings of function codes H50 and H51 will be ignored.

Defining non-linear V/f patterns (F04, F05, H50 and H51)

Function codes F04 and F05 define a non-linear V/f pattern that forms the relationship between the inverter's output frequency and voltage.

Furthermore, setting the non-linear V/f pattern using function codes H50 and H51 allows patterns with higher or lower voltage than that of the normal pattern to be defined at an arbitrary point inside or outside the base frequency. Generally, when a motor is driven at a high speed, its internal impedance may increase and output torque may decrease due to the decreased drive voltage. This feature helps you solve that problem. Note that setting the voltage in excess of the inverter's input source voltage cannot be done.

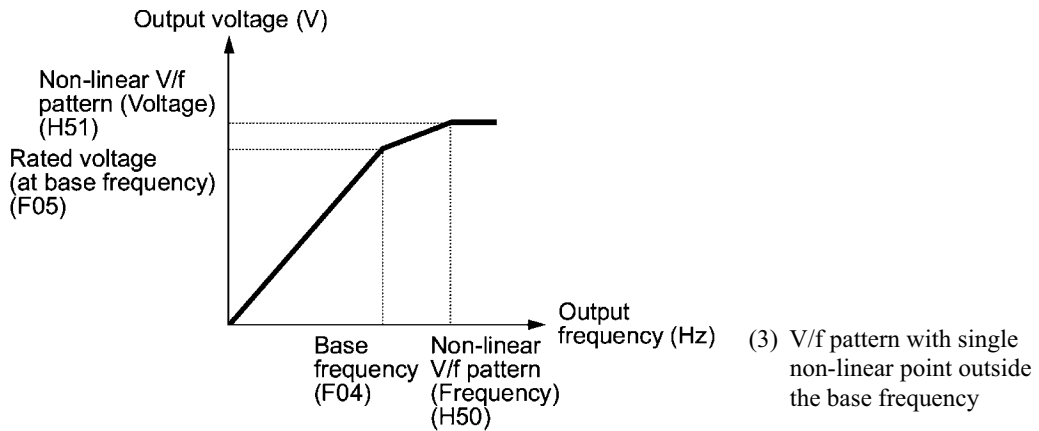
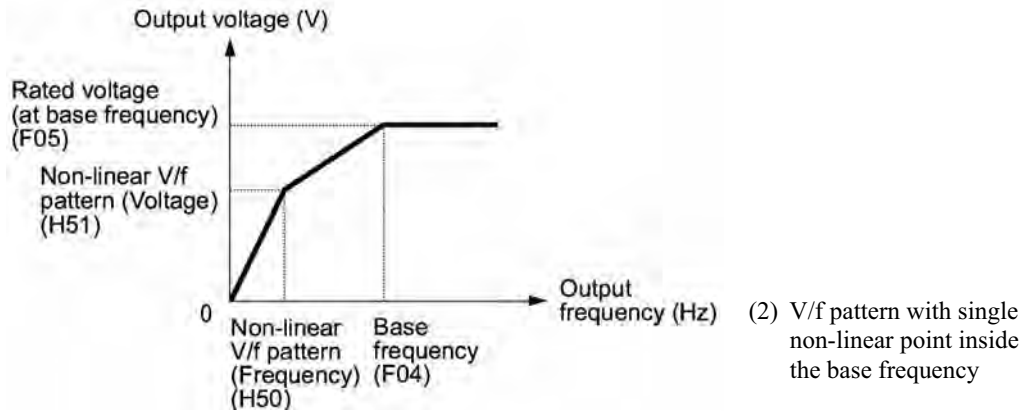
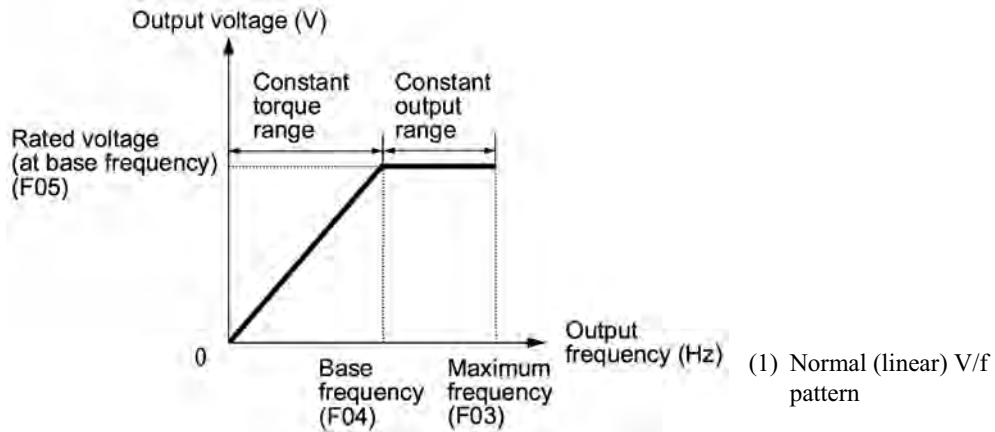

F07	Acceleration Time 1	Refer to E10.
F08	Deceleration Time 1	Refer to E11.

F07 specifies the acceleration time from 0 to the maximum frequency in Hz. F08 specifies the deceleration time from the maximum frequency to 0 in Hz.

- Data setting range: 0.00 to 3600 (sec.)



- Selecting an S-shaped pattern or curvilinear acceleration/deceleration pattern by function code H07 (Gradual acceleration/deceleration pattern) will make the actual acceleration/deceleration times longer than the set ones. Refer to the descriptions of function code H07.
- Setting shorter acceleration/deceleration times than is necessary may make the actual acceleration/deceleration time longer than the set ones, as the current limit or regenerative braking suppression facility may be activated.

F09	Torque Boost
------------	---------------------

Specifies the torque boost rate to boost the voltage component in the V/f pattern for compensating magnetic flux shortage of the motor resulting from the voltage drop across the primary resistance of the motor in the low frequency zone.

- Data setting range: 0.0 to 20.0 (%) (The set voltage at base frequency for F05 is 100%.)



- Set an appropriate torque boost rate that will keep the starting torque of the motor within the voltage level in the low frequency zone. Setting an excessive torque boost rate may result in over-excitation or overheat of the motor during no load operation.
- The F09 data setting is effective for auto torque boost/auto energy saving operations specified by function code F37 being set to 0, 1, 3, or 4.

Variable torque characteristics (F37 = 0)

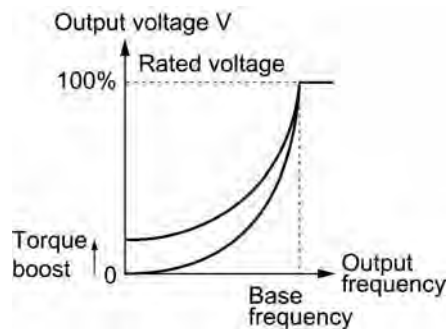

Constant torque characteristics (F37 = 1)

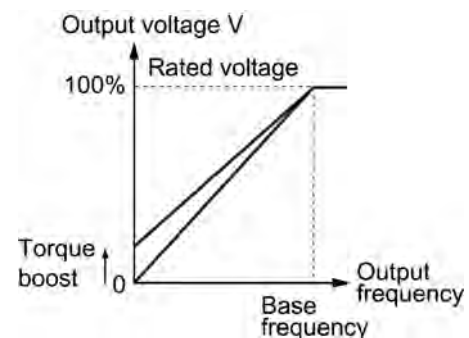

■ Thermal time constant (F12)

F12 specifies the thermal time constant of the motor. The inverter uses the time constant as an operation period of the electronic thermal motor overload protection. If 150% of the overload detection current specified by F11 flows continuously, the inverter activates the electronic thermal motor overload protection during the specified operation period.

For Fuji general-purpose motors and other induction motors, set 5 minutes (factory default) to F12.

- Data setting range: 0.5 to 75.0 (minutes, in 0.1-minute increment)

(Example) When "5.0" (5 minutes) has been set to F12

As shown at the right, if 150% current of the operation level flows continuously for 5 minutes, the motor overload alarm will be activated (alarm code "OL1"). If 120% current flows, the alarm will be activated after approx. 13 minutes.

The thermal time constant includes the time interval from the time when actual current flowing into the motor exceeds the allowable continuous current (100% of the rated current) to the time when the current reaches 150% of the rated current. Therefore, the actual time when the alarm is issued will be earlier than the time specified by F12.

Current-operation time characteristics example

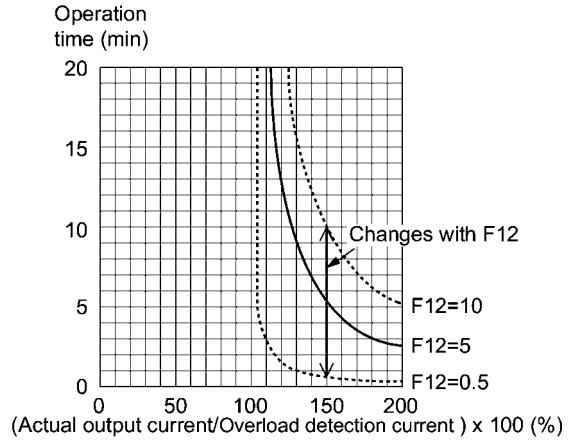

Typical operational characteristics of electronic thermal motor overload protection



When an inverter drives the motor with a very frequent running/stopping operation, the loaded current to the motor may fluctuate largely and enters the short-time rated current range (100% or more) of the motor repeatedly. This may cause an abnormal operation of the electronic thermal motor overload protection (e.g., for an externally-powered forced ventilation fan).

To prevent such a problem, calculate the "equivalent RMS current" and keep the loaded current within the motor rated current. Refer to Chapter 7, Section 7.1.3.4 "Calculating the RMS rating of the motor."

F14 Restart Mode after Instantaneous Power Failure

Selects the action of the inverter to be followed when an instantaneous power failure occurs.

Data for F14	Function
0	Trip immediately
1	Trip after recovery of power
4	Restart at the frequency at which the power failure occurred
5	Restart at the start frequency

If the inverter detects that the DC link bus voltage drops less than the specified undervoltage limit, it interprets the state as an occurrence of an instantaneous power failure. However, if the inverter runs with a light load and the period of the power failure is short, then it does not detect the power failure and continues to run.

■ Trip immediately (F14 = 0)

If an instantaneous power failure occurs when the inverter is in Running mode so that the inverter detects undervoltage of the DC link bus, then the inverter immediately shuts down its outputs and displays the undervoltage alarm "UL" on the LED monitor. The motor will coast to a stop and the inverter will not restart automatically.

■ Trip after recovery of power (F14 = 1)

If an instantaneous power failure occurs when the inverter is in Running mode so that the inverter detects undervoltage of the DC link bus, then the inverter immediately shuts down its outputs without transferring to Alarm mode or displaying the undervoltage alarm "UL." The motor will coast to a stop. When the power is recovered, the inverter will enter Alarm mode for undervoltage.

This setting is used when you run/stop the motor by turning the inverter power on/off with any run command being on. Turning off the controller power with the power switch will not cause the inverter to transfer to Alarm mode or trip.

■ Restart at the frequency at which the power failure occurred (F14 = 4)

If an instantaneous power failure occurs when the inverter is in Running mode so that the inverter detects undervoltage of the DC link bus, then the inverter saves the current output frequency.

When the power is recovered with any run command being ON, the inverter will restart at the saved frequency. During the instantaneous power failure, if the motor speed slows down, the current limiter facility of the inverter will be activated and automatically lower the output frequency. Upon synchronization of the output frequency and motor speed, the inverter accelerates up to the previous output frequency. Refer to the figure (F14 = 4) on the following page for details.

To synchronize the output frequency and motor speed, the instantaneous overcurrent limiter (H12 = 1) should be enabled.

This setting is optimal for operations in which the motor speed rarely slows down due to the heavy moment of inertia of its load even if the motor is coasting to a stop because of the instantaneous power failure.

■ Restart at the start frequency (F14 = 5)

If an instantaneous power failure occurs when the inverter is in Running mode so that the inverter detects undervoltage of the DC link bus, then the inverter immediately shuts down its outputs. After the power is recovered, entry of any run command will restart the inverter at the frequency specified by function code F23. Refer to the figure (F14 = 5) on the following page for details.

This setting is optimal for operations in which the motor speed quickly slows down to 0 r/min due to its heavy load with a very small moment of inertia if the motor coasts to a stop because of the instantaneous power failure.



- There is a 0.5 second delay from detection of the undervoltage until the motor is restarted. This delay is due to the time required for the residual electricity (magnetic flux) in the motor to erase. Therefore, the motor will restart with a 0.5-second delay after the power is recovered, even if the instantaneous power failure period is shorter than 0.5 second.
- When an instantaneous power failure occurs, the power supply voltage for external circuitry (such as relay circuits) controlling the inverter may also drop as low as to cause run commands to be discontinued.

Therefore, during recovery from an instantaneous power failure, the inverter waits 2 seconds for a run command to arrive. If it receives one within 2 seconds, it will restart. If a run command arrives more than 2 seconds later, then the inverter should be restarted at the start frequency (F23). The external circuitry should be so designed that it will issue a run command within 2 seconds in such an event; otherwise it should incorporate a relay with a mechanical locking feature.

- If a coast-to-stop command (BX) is issued during an instantaneous power failure, the inverter exits from the state of waiting for restarting, and enters Running mode. If any run command is issued, the inverter will start at the start frequency preset.

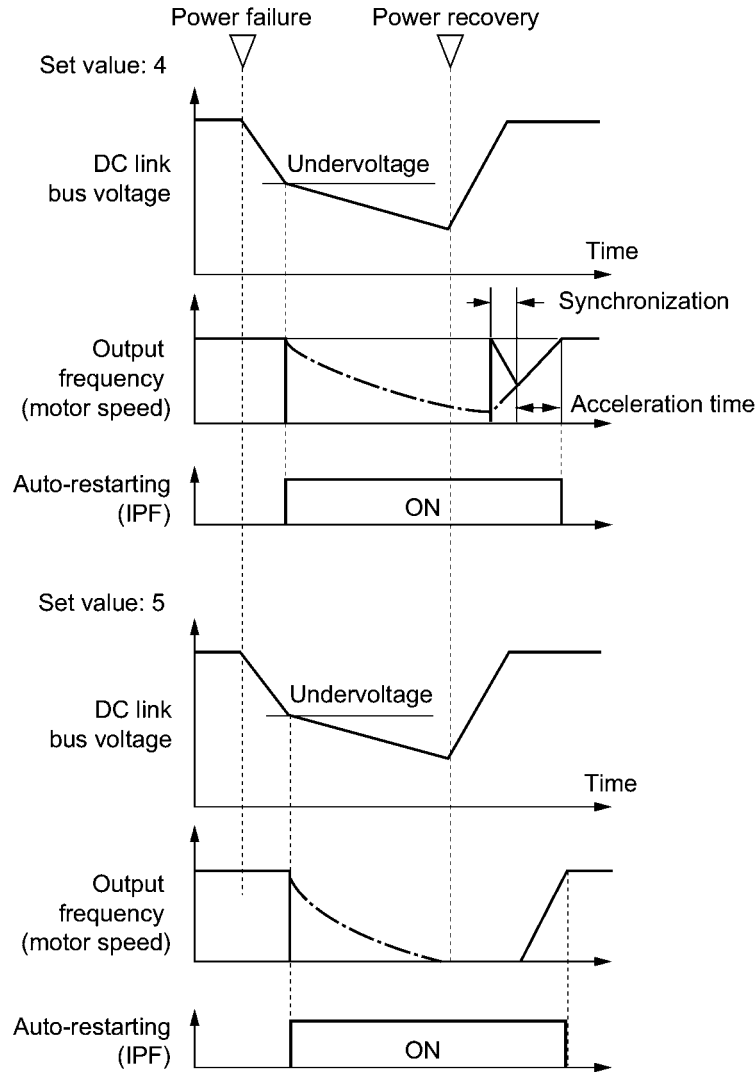

F15	Frequency Limiter (High)
F16	Frequency Limiter (Low)

Frequency limiter F15 limits the peak of output frequency. Frequency limiter F16 maintains the output frequency at the bottom even if the set frequency is lower than the bottom. Refer to the figure at the right.

- Data setting range: 0.0 to 400.0 Hz

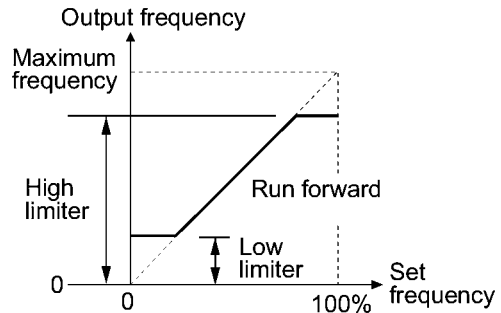

Set the peak and bottom frequencies correctly; otherwise, the inverter may not operate. Maintain the following relationship between the limiters:

- (Peak frequency) > (Bottom frequency), (Start frequency), (Stop frequency)
- (Bottom frequency) < (Maximum frequency)

If you select any analog input for frequency command 1, it is possible to define the relationship between the analog input and the set frequency arbitrarily by combining the settings for bias (F18), bias reference point (C50), gains (C32 and C37), and gain reference points (C34 and C39) as shown below.

Function code	Function	Data entry range (%)
F18	Bias	-100.00 to 100.00
C50	Bias reference point	0.00 to 100.00
C32	Gain for terminal [12]	0.00 to 200.00
C34	Gain reference point for terminal [12]	0.00 to 100.00
C37	Gain for terminal [C1]	0.00 to 200.00
C39	Gain reference point for terminal [C1]	0.00 to 100.00

As illustrated in the graph below, the relationship between the set frequency and analog input for frequency command 1 is shown by a straight line passing through points "A" and "B." The "A" is determined by the bias (F18) and its reference point (C50). The "B" is determined by the gain (C32 or C37) and its reference point (C34 or C39). The combination of C32 and C34 will apply for terminal [12] and that of C37 and C39 for terminal [C1].

The bias (F18) and gain (C32 or C37) should be set, assuming the maximum frequency as 100%. The bias reference point (C50) and gain frequency point (C34 or C39) should be set, supposing the full scale (10 VDC or 20 mADC) as 100%.

If the set frequency 1 is set with the built-in potentiometer, point B is prefixed at both the gain and its reference point being 100%.

Note Analog input under the bias reference point is limited by the bias data.

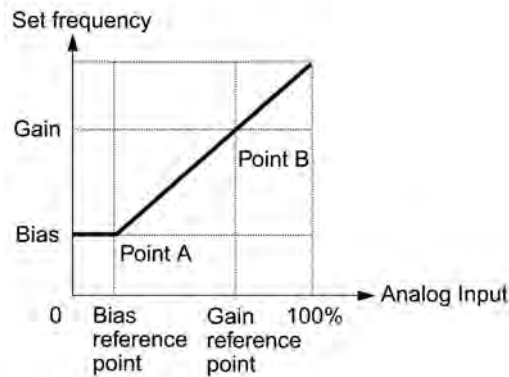

The relations stated above are stated in the following expressions:

- (1) If analog input \leq bias reference point:

$$\text{Frequency Setting 1 (\%)} = \text{Bias (F18)}$$

- (2) If analog input $>$ bias reference point:

$$\begin{aligned} \text{Frequency Setting 1 (\%)} &= \frac{(\text{Gain}) - (\text{Bias})}{(\text{Gain reference point}) - (\text{Bias reference point})} (\%) \times \text{Analog input (\%)} \\ &+ \frac{(\text{Bias}) \times (\text{Gain reference point}) - (\text{Gain}) \times (\text{Bias reference point})}{(\text{Gain reference point}) - (\text{Bias reference point})} \\ &= \frac{\text{C32} - \text{F18}}{\text{C34} - \text{C50}} (\%) \times \text{Analog input (\%)} + \frac{\text{F18} \times \text{C34} - \text{C32} \times \text{C50}}{\text{C34} - \text{C50}} \end{aligned}$$

In the above expressions, it is assumed that each function code expresses its data.

Example: Setting the bias, gain and its reference point when analog input range from 1 to 5 VDC is selected for the frequency command 1

(Point A)

If the analog input is at 1 V, the set frequency is 0 Hz. Therefore, the bias is 0% ($F18 = 0$). Since 1 V is the bias reference point and it is equal to 10% of 10 V, then the bias reference point should be 10% ($C50 = 10$).

(Point B)

If the analog input is at 5 V, the set frequency comes to be the maximum value. Therefore, the gain is 100% ($C32 = 100$). Since 5 V is the gain reference point and it is equal to 50% of 10 V, then the gain reference point should be 50% ($C34 = 50$).

Note When using the function codes for setting a stand alone gain or bias without changing any reference points, the setting procedure for the function codes is the same as that of Fuji conventional inverter models.

F20	DC Braking (Start frequency)
F21	DC Braking (Braking level) Refer to H95.
F22	DC Braking (Braking time)

These function codes specify the parameters for DC braking, a mechanism to pre-vent the motor from coasting due to the inertia of moving loads while it is decelerating to a stop. During a decelerated stop cycle, i.e., when any Run command "OFF" has been issued or the set frequency has dropped below the stop frequency, DC braking is invoked as soon as the output frequency has reached the start frequency (F20) for DC braking.

Set function codes F20 for the start frequency, F21 for the braking level, and F22 for the braking time. Optionally, you can also select the quick-response DC braking with H95.

■ Start frequency (F20)

Set the frequency with which to start DC braking.

- Data setting range: 0.0 to 60.0 (Hz)

Note Set function code F20 to a frequency that approximately equals the slip-compensated frequency of the motor. If you set it to an extremely high frequency, the inverter will be unstable, and in some cases the overvoltage protective function may work.

■ Braking level (F21)

Set the output current level to be applied when DC braking is activated. Set the function code data, assuming the rated output current of the inverter as 100% with 1-% resolution.

- Data setting range: 0 to 100%

■ Braking period (F22)

Set the braking period during which DC braking is activated.

- Data setting range: 0.00 to 30.00 (sec.)

(Note that setting 0.00 disables DC braking.)

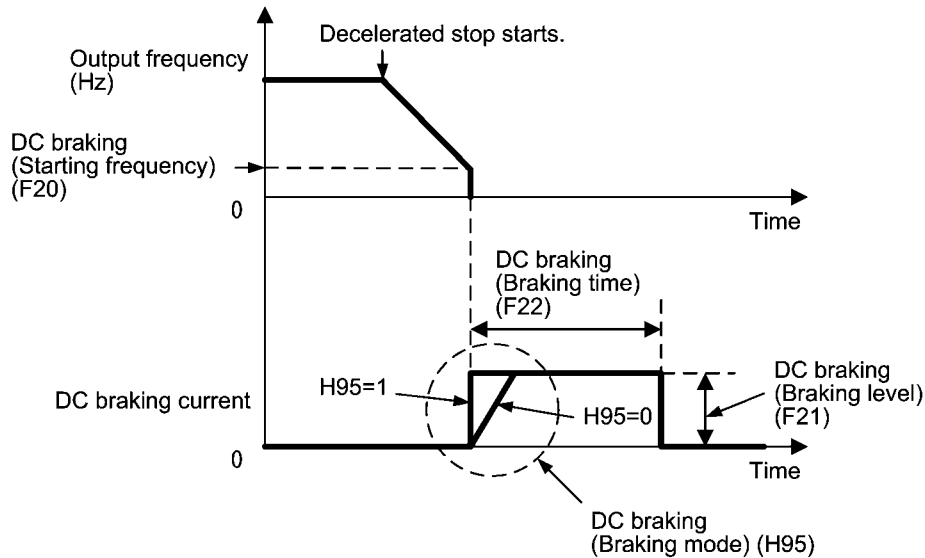

H95 specifies the DC braking mode as follows:

Data for H95	Braking mode	Meaning
0	Slow response	The DC braking current gradually ramps up. (The torque may not be sufficient at the start of DC braking.)
1	Quick response	The DC braking current quickly ramps up. (Depending on the inertia of the moving loads or the coupling state, the revolution may be unstable.)



For three-phase 230 V and single-phase 230 V inverters

The braking level setting for the three-phase 230 V and single-phase 230 V series should be calculated from the DC braking level I_{DB} (A) based on the reference current I_{ref} (A), as shown below.

$$\text{Setting (\%)} = \frac{I_{DB} \text{ (A)}}{I_{ref} \text{ (A)}} \times 100$$

(Example) Setting the braking level I_{DB} at 4.2 Amp (A) for 1 HP (0.75 kW) standard motors

$$\text{Setting (\%)} = \frac{4.2 \text{ (A)}}{5.0 \text{ (A)}} \times 100 = 84$$

Applicable motor rating [HP (kW)]	1/8 (0.1)	1/4 (0.2)	1/2 (0.4)	1 (0.75)	2 (1.5)	3 (2.2)	5 (3.7)
Reference current I_{ref} (A)	0.8	1.5	3.0	5.0	8.0	11.0	17.0

⚠ CAUTION

The brake function of the inverter does not provide mechanical holding means.
Injuries could occur.

F23**Start Frequency****F25****Stop Frequency**

The start frequency refers to the output frequency that the inverter should output at start up. The inverter shuts down its output at the stop frequency.

Set the start frequency to a level that will enable the motor to generate enough torque for startup. Generally, set the rated slip frequency to F23.

- Data setting range: 0.0 to 60.0 (Hz) (for both start and stop frequencies)



If the start frequency is lower than the stop frequency, the inverter cannot output any power as long as the set frequency does not exceed the stop frequency.

F26**Motor Sound (Carrier frequency)****Refer to H98.**

Sets the carrier frequency.

- Data setting range: 0.75 to 15 (kHz)
- Changing the carrier frequency may decrease the motor running noise, leakage current from the output lines, and electric noise from the inverter.

Carrier frequency	0.75 to 15 kHz
Motor running noise	Noisy to quiet
Output current waveform	Poor to good
Leakage current level	Low to high
Electric noise level	Low to high



Lowering the carrier frequency increases the ripple components (harmonic components) on the output current waveform so as to increase the motor's power loss and raises the temperature of the motor. If the carrier frequency is set at 0.75 kHz, for example, estimate the motor output torque at 85% or less of the rated motor torque.

On the contrary, raising the carrier frequency increases the inverter's power loss and raises the temperature of the inverter. The inverter has a built-in overload protection facility that automatically decreases the carrier frequency to protect the inverter. For details about the facility, refer to function code H98.

F27**Motor Sound (Tone)**

Changes the motor running sound tone. This setting is effective when carrier frequencies set to function code F27 is 7 kHz or lower. Changing the tone level may reduce the high and harsh running noise from the motor.

Data for F27	Function
0	Tone level 0
1	Tone level 1
2	Tone level 2
3	Tone level 3

F30**Terminal [FMA] (Gain to output voltage)****F31****Analog Output Signal Selection for [FMA] (Monitor object)**

F31 allows you to output monitored data (such as the output frequency or output current) to terminal [FMA] as an analog data that can be adjusted with F30 for the meter scale.

■ Adjusting the output voltage level (F30)

Adjust the output voltage level within the range of 0 to 200%, supposing the monitored amount of the monitor selected with function code F31 as 100%.

- Data setting range: 0 to 200 (%)

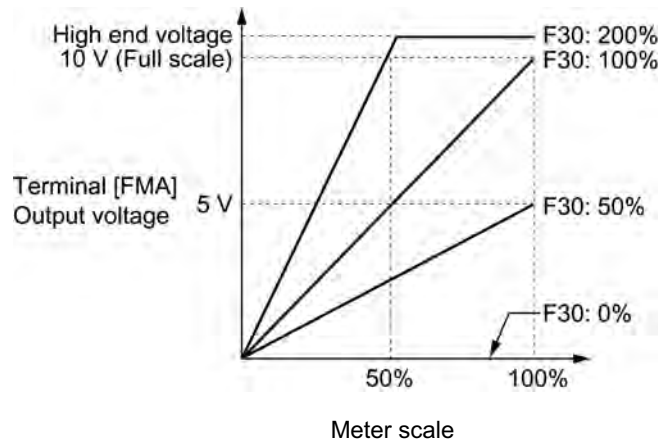

■ Selecting object to be monitored (F31)

Select the output to terminal [FMA] for monitoring.

Data for F31	Function (Monitor the following)	Based on the following defined as 100% (full-scale)
0	Output frequency (before slip compensation)	Maximum output frequency
1	Output frequency (after slip compensation)	Maximum output frequency
2	Output current	Two times the inverter's rated output current
3	Output voltage	230 V class: 250 V 460 V class: 500 V
6	Input power	Two times the inverter's rated output capacity
7	PID feedback value	Feedback value is 100%
9	DC link bus voltage	230 V class: 500 V 460 V class: 1000 V
14	Test output (+)	10 V (with gain 100%)

F37**Load Selection/Auto Torque Boost/Auto Energy Saving Operation**

Allows you to select the load type and enable/disable auto torque boost and auto energy saving operation. The load selection enables an optimal V/f pattern to be selected.

Load selection

There are two different properties of loads--the torque load which is in proportion to the square of speed and the constant torque load. You can select a V/f pattern optimized to the load property. Refer to the figure in the descriptions for function code F09 for details.

Auto torque boost

This feature optimizes the output voltage automatically to the motor and its load. Even if the load varies, the inverter can maintain the exciting current fed to the motor so as not to over-excite the motor. The maximum output torque of the motor will be increased.



- If the automatic torque boost is enabled (F37 = 2 or 5), function code F09 will be ignored.
- If either the torque in proportion to the square of the speed or the constant torque is selected (F37 = 0, 1, 3, or 4), it is necessary to modify the F09 data (Torque boost: 0.0 to 20.0%).
- If a motor parameter is a special one or the rigidity of the load is not sufficient, lowering the maximum output torque or unstable operation may sometimes result. To avoid this happening, disable the automatic torque boost (F37 = 0 or 1) and set the torque boost with F09 manually.

Auto energy saving operation

This feature controls the terminal voltage of the motor automatically to minimize the motor power loss. (Note that this feature may not be effective depending upon the motor characteristics. Check the properties before using this feature.)

The inverter enables this feature for constant speed operation only. During acceleration and deceleration, the inverter will run with manual or automatic torque boost, depending on the data setting of function code F37. If auto energy-saving operation is enabled, the response to a change in motor speed may be slow. Do not use this feature for a system that requires quick acceleration and deceleration.

Data for F37	Load selection	Auto torque boost	Auto energy saving	F09	Remarks
0	Variable torque	Disabled	Disabled	Enabled	
1	Constant torque	Disabled	Disabled	Enabled	
2	Not available	Enabled	Disabled	Disabled	
3	Variable torque	Disabled	Enabled	Enabled	The auto energy-saving feature is enabled only for constant speed operation. During acceleration/ deceleration, the inverter runs with manual or automatic torque boost.
4	Constant torque	Disabled	Enabled	Enabled	
5	Not available	Enabled	Enabled	Disabled	



When using the auto torque boost or energy-saving feature, you need to set the rated voltage of the motor to F05 (Voltage at the base frequency) and the motor parameters to the motor-related P codes.

F43	Current Limiter (Operation condition)
------------	--

F44	Current Limiter (Limiting level)
------------	---

F43 enables or disables the current limiter. If it is enabled, the inverter controls the output frequency while keeping the current set to F44 in order to prevent the motor from stalling.

With F43, you may select whether the current limiter works during constant speed operation only (F43 = 1) or during both acceleration and constant speed operation (F43 = 2). Set F43 to 1, for example, to drive the motor at maximum performance in the acceleration zone and to limit the drive current in the constant speed zone.

■ Operation condition (F43)

Select the motor running state in which the current limiter will work.

Data for F43	Function
0	Disable (No current limiter works.)
1	Enable the current limiter during constant speed operation
2	Enable the current limiter during acceleration and constant speed operation

■ Limiting level (F44)

Select the level at which the current limiter will work.

- Data setting range: 20 to 200% (Percentage ratio of rated current of the inverter)



- The current limiting feature selected by F43 and F44 are implemented by software, so an operational delay may occur. To avoid the delay, use the current limiter (hardware) simultaneously (H12 = 1).
- If an overload is applied when the limiting level is set extremely low, the inverter will immediately lower its output frequency. This may cause an overvoltage trip or dangerous turnover of the motor rotation due to undershooting.

F50	Electronic Thermal Overload Relay (Discharging capability)
------------	---

F51	Electronic Thermal Overload Relay (Allowable loss)
------------	---

These function codes configure the electronic thermal overload relay to protect the braking resistor from overheating.

Set the discharging capability and allowable average loss of braking resistors to F50 and F51, respectively. Those values differ depending upon the specifications of the braking resistor. Refer to the tables on the next page.

For built-in braking resistors, you may set 0 and 0.000 to F50 and F51, respectively. Doing so will automatically apply the settings given in the table on the next page.

Refer to Chapter 7, Section 7.2 "Selecting a Braking Resistor" for details.



Depending on the discharging capability margin of a braking resistor, the electronic thermal function may operate and issue the overheat alarm "obH," even if the actual temperature of the resistor is lower than that specified. Check braking resistor performance again and review the data setting of function codes F50 and F51.

The following tables list the discharging capability and allowable average loss of the FRENIC-Mini series of inverters. These values are determined by inverter model and specifications (built-in or external type) of braking resistors.

■ Built-in braking resistor

Power supply voltage	Inverter type	Resistance (Ω)	Capacity (W)	Continuous braking (Braking torque: 100%)		Repetitive braking (Period: 100 sec. or less)	
				Discharging capability (kW)	Braking time (s)	Allowable average loss (kW)	Duty cycle (%ED)
Three-phase 230V	FRN002C1■-2U21	60	40	14	18	0.023	3
	FRN003C1■-2U21				12		2
	FRN005C1■-2U21	40	60	15	8	0.025	1.5
Three-phase 460V	FRN002C1■-4U21	240	40	14	18	0.023	3
	FRN003C1■-4U21				12		2
	FRN005C1■-4U21	160		15	8	0.025	1.5

Note 1) A box (■) in the above table replaces S or E depending on the enclosure.

■ External braking resistor

Standard Models

The braking resistor is protected from overheating by a thermal relay incorporated in the braking resistor. Assign "external thermal relay tripped" (THR) to one of the inverter's digital input terminals [X1], [X2], [X3], [FWD], and [REV], and connect it to the terminals 2 and 1 of the braking resistor.

If you choose not to use the thermal relay incorporated in the braking resistor, set up the overheat protection device using the values given in the table below.

Power supply voltage	Inverter type	Braking resistor type	Q'ty	Resistance (Ω)	Capacity (W)	Continuous braking (Braking torque: 100%)		Repetitive braking (Period: 100 sec. or less)	
						Discharging capability (kW _s)	Braking time (s)	Allowable average loss (kW)	Duty cycle (%ED)
Three-phase 230V	FRNF50C1■-2U	DB0.75-2	1	100	200	9	45	0.044	22
	FRN001C1■-2U					17		0.068	18
	FRN002C1■-2U**	DB2.2-2		34	30	0.075		10	
	FRN003C1■-2U**			33		0.077	7		
	FRN005C1■-2U**	DB3.7-2		33	37	20	0.093	5	
Three-phase 460V	FRNF50C1■-4U	DB0.75-4		200	200	9	45	0.044	22
	FRN001C1■-4U					17		0.068	18
	FRN002C1■-4U**	DB2.2-4		160	400	34		30	0.075
	FRN003C1■-4U**					33	0.077		7
	FRN005C1■-4U**	DB3.7-4		130	37	20	0.093	5	
Single-phase 230V	FRNF50C1■-7U	DB0.75-2	100	200	9	45	0.044	22	
	FRN001C1■-7U				17		0.068	18	
	FRN002C1■-7U	DB2.2-2	40	400	34		30	0.075	10
	FRN003C1■-7U				33	0.077		7	

Note 1) A box (■) in the above table replaces S or E depending on the enclosure.

2) Asterisks (**) in the above table denote the following:

21: Braking resistor built-in type, None: Standard

10% ED Models

Power supply voltage	Inverter type	Braking resistor type	Q'ty	Resistance (Ω)	Capacity (W)	Continuous braking (Braking torque: 100%)		Repetitive braking (Period: 100 sec. or less)	
						Discharging capability (kW)	Braking time (s)	Allowable average loss (kW)	Duty cycle (%ED)
Three-phase 230V	FRNF50C1 ■-2U	DB0.75-2C	1	100	200	50	250	0.075	37
	FRN001C1 ■-2U						133		20
	FRN002C1 ■-2U**	DB2.2-2C		40	400	55	73	0.110	14
	FRN003C1 ■-2U**						50		10
	FRN005C1 ■-2U**	DB3.7-2C		33		140	75	0.185	10
Three-phase 460V	FRNF50C1 ■-4U	DB0.75-4C		200	200	50	250	0.075	37
	FRN001C1 ■-4U						133		20
	FRN002C1 ■-4U**	DB2.2-4C		160	400	55	73	0.110	14
	FRN003C1 ■-4U**						50		10
	FRN005C1 ■-4U**	DB3.7-4C		130		140	75	0.185	10
Single-phase 230V	FRNF50C1 ■-7U	DB0.75-2C	100	200	50	250	0.075	37	
	FRN001C1 ■-7U					133		20	
	FRN002C1 ■-7U	DB2.2-2C	40	400	55	73	0.110	14	
	FRN003C1 ■-7U					50		10	

Note 1) A box (■) in the above table replaces S or E depending on the enclosure.

2) Asterisks (**) in the above table denote the following:

21: Braking resistor built-in type, None: Standard

Calculating discharging capability and allowable average loss and then setting function code data

■ Discharging capability (F50)

Discharging capability stands for the amount of electric power that a braking resistor can discharge for a single cycle of braking operation. It can be calculated using the braking period and rated motor capacity using equation (1), which is based on the regenerative power in deceleration or equation (2), which is based on that in constant speed operation.

$$\text{Discharging Capability (kWs)} = \frac{\text{Braking Time (s)} \times \text{Rated Motor Capacity (HP)}}{2} \quad (1)$$

$$\text{Discharging Capability (kWs)} = \text{Braking Time (s)} \times \text{Rated Motor Capacity (HP)} \quad (2)$$

Data for F50	Function
0	Apply the discharging capability specified for braking resistor built-in type
1 to 900	Discharge 1 to 900 kW
999	Disable electronic thermal overload protection

■ Allowable average loss (F51)

Allowable average loss is a braking resistor capacity that can be applied for continuous operation of a motor. It can be calculated from the %ED and rated motor capacity using equation (3), which is based on the regenerative power in deceleration or equation (4), which is based on that in constant speed operation.

$$\text{Allowable Loss (kW)} = \frac{\frac{\%ED (\%)}{100} \times \text{Rated Motor Capacity (HP)}}{2} \quad (3)$$

$$\text{Allowable Average Loss (kW)} = \frac{\%ED (\%)}{100} \times \text{Rated Motor Capacity (HP)} \quad (4)$$

Data for F51	Function
0	Apply the allowable average loss specified for braking resistor built-in type
0.001 to 50.000	Discharge 0.001 to 50.000 HP

9.2.2 E codes (Extension terminal functions)

E01 to E03

Terminal Command Assignment to [X1] to [X3]

Refer to E98 and E99.

E01 to E03, E98 and E99 may assign commands (listed below) to terminals [X1] to [X3], [FWD], and [REV] which are general-purpose programmable input terminals.

These function codes may also switch the logic system between normal and negative to define how the inverter logic interprets either ON or OFF status of each terminal. The default setting is normal logic, that is "Active ON."

To assign negative logic input to any input terminal, set the function code to the value of 1000s shown in () in the table below. To keep explanations as simple as possible, the examples shown below are all written for the normal logic system.

Data for E01 to E03, E98 and E99	Terminal command assigned	Command symbols (Input signals)
0, 1, 2 (1000, 1001, 1002)	Select multistep frequency (0 to 7 steps)	(SS1), (SS2) and (SS4)
4 (1004)	Select ACC/DEC time	(RT1)
6 (1006)	Enable 3-wire operation (2 steps)	(HLD)
7 (1007)	Coarse to a stop	(BX)
8 (1008)	Reset alarm	(RST)
9 (1009)	Enable external alarm trip	(THR)
10 (1010)	Ready for jogging	(JOG)
11 (1011)	Switch frequency command 2/1	(Hz2/Hz1)
19 (1019)	Enable write from keypad	(WE-KP)
20 (1020)	Cancel PID control	(Hz/PID)
21 (1021)	Switch normal/inverse operation	(IVS)
24 (1024)	Enable communications link (RS-485 communication, option)	(LE)
33 (1033)	Reset PID integral and differential components	(PID-RST)
34 (1034)	Hold PID integral component	(PID-HLD)
98*	Run forward. Short-circuiting terminals [FWD] and [CM] runs the motor forward. Opening them decelerates the motor to stop	(FWD)
99*	Run reverse. Short-circuiting terminals [REV] and [CM] runs the motor reverse. Opening them decelerates the motor to stop	(REV)

* No negative logic input is allowed for data 98 and 99. Note that negative logic input can never be used for the motor drive commands (FWD) and (REV).



(Example using negative logic system)

Assigning multistep frequency 2 (SS2) to terminal [X1]

If function code E01 is set to 1, logic is normal ("Active ON"). Short-circuiting terminals [X1] and [CM] makes (SS2) active.

If E01 is set to 1001, logic is negative ("Active OFF"). Opening the circuit between [X1] and [CM] makes (SS2) active.

Terminal function assignment and data setting

- Select multistep frequency--(SS1), (SS2), and (SS4)
(Function code data = 0, 1, and 2)

Switching digital input signals (SS1), (SS2), and (SS4) ON/OFF may switch the present set frequency to those defined by function codes C05 through C11 (multistep frequencies). With this, the inverter may drive the motor at 8 different preset speeds.

The table below lists the frequencies that can be obtained by the combination of switching (SS1), (SS2), and (SS4). In the column "Selected frequency," "Other than multistep frequency" represents the set frequencies defined by frequency command 1 (F01), frequency command 2 (C30), and others. For details, refer to the block diagram in Chapter 4, Section 4.2 "Drive Frequency Command Generator."

Terminal [X3] (Function code E03)	Terminal [X2] (Function code E02)	Terminal [X1] (Function code E01)	Selected frequency
2 (SS4)	1 (SS2)	0 (SS1)	
OFF	OFF	OFF	Other than multistep frequency
OFF	OFF	ON	C05 (multistep frequency 1)
OFF	ON	OFF	C06 (multistep frequency 2)
OFF	ON	ON	C07 (multistep frequency 3)
ON	OFF	OFF	C08 (multistep frequency 4)
ON	OFF	ON	C09 (multistep frequency 5)
ON	ON	OFF	C10 (multistep frequency 6)
ON	ON	ON	C11 (multistep frequency 7)

- Select ACC/DEC time (2 steps)--(RT1)
(Function code data = 4)

Digital input signal (RT1) assigned to the specified terminal ON/OFF may switch combinations between acceleration/deceleration time 1 (defined by function codes F07 and F08) and acceleration/deceleration time 2 (defined by E10 and E11).

Turning (RT1) ON, for example, enables the inverter to drive the motor using acceleration/deceleration time 2.

(RT1)	Selected acceleration/deceleration time
OFF	F07: Acceleration time 1 F08: Deceleration time 1
ON	E10: Acceleration time 2 E11: Deceleration time 2



The above acceleration/deceleration time switching takes effect also in S-curved or curvilinear operation defined by H07.

■ Enable 3-wire operation--(HLD)
(Function code data = 6)

Digital input signal (HLD) may self-hold the forward (FWD)/reverse (REV) run commands given at the external signal input terminals to enable 3-wire inverter operation.

Shorting the circuit between the (HLD)-assigned terminal and terminal [CM] will self-hold the (FWD) or (REV) command. Opening the circuit will release the hold.

If (HLD) is not assigned to any terminal, the inverter runs in 2-wire operation using (FWD) and (REV).

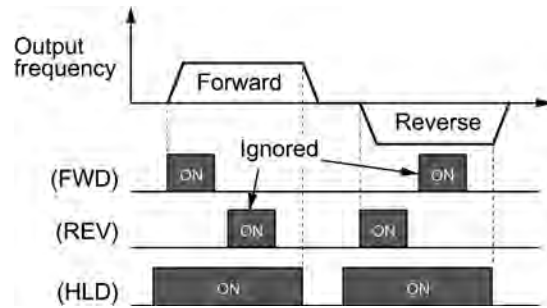

■ Coast to a stop--(BX)
(Function code data = 7)

Shorting the circuit between the (BX)-assigned terminal and terminal [CM] will immediately shut down the inverter output so that the motor will coast to a stop without issuing any alarms.

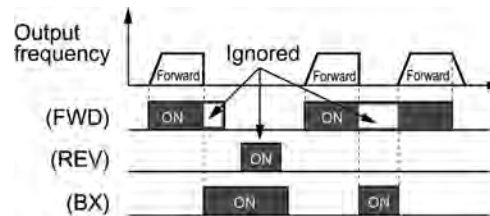

■ Reset alarm--(RST)
(Function code data = 8)

When the protective function has been activated (the inverter is in Alarm mode), shorting the circuit between the (RST)-assigned terminal and terminal [CM] will reset the alarm output on terminals [Y1] and [30A/B/C]. Opening the circuit will release all the alarm indications to restart operation. Allow 10 ms or more for the short-circuit time.

(RST) should be kept OFF for normal inverter operation.

■ Enable external alarm trip--(THR)
(Function code data = 9)



When the motor is running, opening the circuit between the (THR)-assigned terminal and terminal [CM] will immediately shut down the inverter output and issue the alarm "OH2." The motor will coast to a stop.

This signal will be self-held inside the inverter until the  key is pressed to reset it or any other reset action is taken. If (THR) is not assigned to any terminal, the inverter interprets this as (THR) always being ON.



 Use this function to protect the external-braking resistor from overheating.



- Ready for jogging--(JOG)
(Function code data = 10)

Turning ON the (JOG) command makes the motor ready for jogging. Use this command for fine adjustment to position a workpiece, for example.

Simultaneous  +  keying may also make the motor ready for jogging depending upon whether keypad operation or terminal command operation is selected and whether the (JOG) command is ON or OFF, as listed below.

When keypad operation is selected (F02 = 0, 2, or 3)

If (JOG) is:	 +  keying	The motor becomes ready for:
ON	Disabled.	Jogging
OFF	Toggles between normal and jogging.	Normal running
		Jogging

When terminal command operation is selected (F02 = 1), simultaneous  +  keying is disabled.

Jogging

When the motor is ready for jogging with (JOG) being ON, pressing the  key or turning the (FWD) or (REV) command ON will start the motor to jog.

If the  key is released, the motor will decelerate to a stop.

Jogging operation follows the settings of:

- Jogging frequency set by function code C20
- Acceleration or deceleration time set by function code H54



- Switching between the ready-to-jog and ready-to-run statuses is possible only when the inverter stops its output, not possible when it is running the motor.
- To jog the motor by the concurrent input of (JOG) and run command (e.g., (FWD)), the input time lag between those commands should be within 100 ms; otherwise, the inverter will not jog the motor.

If the (FWD) command is turned ON preceding the (JOG) command, the inverter runs the motor in ordinary operation until the (JOG) is turned ON.

- Switch frequency command 2/1--(Hz2/Hz1)
(Function code data = 11)

Turning the digital input signal (Hz2/Hz1) ON/OFF can switch the frequency setting means between frequency command 1 (defined by function code F01) and frequency command 2 (defined by function code C30).

If (Hz2/Hz1) is not assigned to any terminal, the frequency setting means defined by function code F01 will take effect.

(Hz2/Hz1)	Frequency setting means
OFF	F01: Frequency command 1
ON	C30: Frequency command 2

 For details of the relationship for frequency settings other than frequency command 1 or 2, refer to Chapter 4, Section 4.2 "Drive Frequency Command Generator."

- Enable write from keypad--(WE-KP)
(Function code data = 19)

Turning OFF the (WE-KP) command prohibits changing of function code data from the keypad.

Only when the (WE-KP) command is turned ON, you may access function code data from the keypad according to the setting of function code F00 as listed below.

If the (WE-KP) command is not assigned to any terminal, the inverter will interpret (WE-KP) as being always ON.

If (WE-KP) is set to:	F00	Function
OFF	Disabled.	Inhibit editing of function code data
ON	0	Permit editing of function code data
	1	Inhibit editing of function code data except F00 and H03

Note If you mistakenly assign the (WE-KP) command to any terminal, function code data will be no longer edited. To cancel such an undesired assignment, turn the (WE-KP) command ON once (by short-circuiting between the (WE-KP)-assigned terminal and terminal [CM]) and then reassign a correct command to the terminal.

- Cancel PID control--(Hz/PID)
(Function code data = 20)

Turning the (Hz/PID) command ON/OFF enables or disables the PID control.

If the PID control is disabled with the (Hz/PID) being OFF, the inverter runs the motor with the frequency manually set by any of the multistep, keypad, or analog input.

(Hz/PID)	Selected function
OFF	Enable PID control
ON	Disable PID control / Enable manual settings

 Refer to Chapter 4, Section 4.8 "PID Frequency Command Generator" for details.

- Switch normal/inverse operation--(IVS)
(Function code data = 21)

Turning the (IVS) command ON/OFF switches the output frequency control between normal (proportional to the set frequency components) and inverse operation for the PID process or manually set frequencies. To select the inverse operation, switch the (IVS) command to ON.

When the PID control is enabled, turning the (IVS) command ON inverts the PID process control selected by function code J01. For example, if the PID process control is normal, turning it ON switches it to inverse, or vice versa.

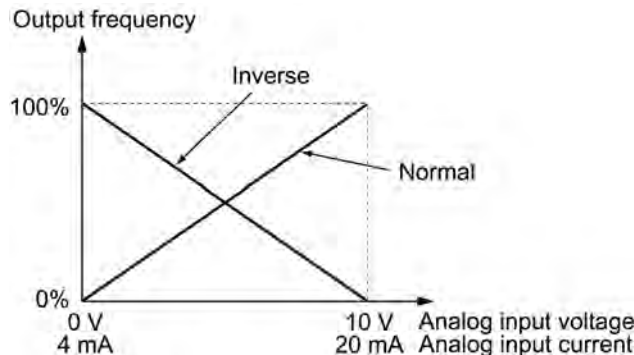

For ordinary set frequency (J01 = 0)

If (IVS) is:	Set frequency
OFF	Normal operation
ON	Inverse operation

For PID control (J01 = 1 or 2)

If (IVS) is:	Selected PID control (J01)	PID operation
OFF	1: Normal operation	Normal
ON	1: Normal operation	Inverse
OFF	2: Inverse operation	Inverse
ON	2: Inverse operation	Normal

- Enable communications link--(LE)
(Function code data = 24)

Turning ON the (LE) command selects link operation. The inverter will run the motor with the frequency command or drive command given via the RS-485 communications facility defined by function code H30.

If the (LE) command is not assigned to any terminal, the inverter will interpret (LE) as being always ON.

 Refer to Chapter 4, Sections 4.2 "Drive Frequency Command Generator," 4.3 "Drive Command Generator" and 4.4 "Terminal Command Decoders," and the RS-485 Communication User's Manual for more details.

- Reset PID integral and differential components--(PID-RST)
(Function code data = 33)

Turning ON the (PID-RST) command resets the PID integral and differential components.

- Hold PID integral component--(PID-HLD)
(Function code data = 34)

Turning ON the (PID-HLD) command holds the current inverter output voltage constant by suppressing an increase of PID integral component.

- Run forward--(FWD)
(Function code E98/E99 data = 98)

If the (FWD) command is turned ON, the inverter runs the motor forward; if OFF, it decelerates the motor to a stop.

- Run reverse--(REV)
(Function code E98/E99 data = 99)

If the (REV) is turned ON, the inverter runs the motor in reverse; if OFF, it decelerates the motor to a stop.

E10	Acceleration Time 2	Refer to F07.
E11	Deceleration Time 2	Refer to F08.

Refer to the descriptions of function codes F07 and F08.

E20 and E27**Status Signal Assignment to [Y1], [30A], [30B] and [30C]**

E20 to E27 may assign output signals (listed below) to terminals [Y1] (transistor switch) and [30A], [30B] and [30C] (mechanical relay contacts) which are general-purpose programmable output terminals.

These function codes may also switch the logic system between normal and negative to define the property of those output terminals so that the inverter logic may interpret either the ON or OFF status of each terminal as active.

Terminals [30A], [30B], and [30C] are mechanical relay contacts. In the normal logic, if an alarm occurs, the relay will be excited so that [30A] and [30C] will be short-circuited, signaling an occurrence of the error to external equipment. On the other hand, in the negative logic, the relay will cut off the excitation current to open [30A] and [30C]. This may be useful for the implementation of failsafe power systems.

The default setting is normal logic, that is "Active ON."

To assign negative logic input to any input terminal, set the function code to the value of 1000s shown in () in the table below. To keep explanations as simple as possible, the examples shown below are all written for the normal logic system.

 When negative logic is active, the inverter switches all output signals to the active side (for example, the alarm side). To avoid system malfunctions caused by this, interlock the signals to keep them ON using an external power source. To use negative logic with the output signal, set the data of 1000s in () as listed in the table below.

Data for E20 or E27	To assign the following status signals to terminals:	Output signal symbols
0 (1000)	Inverter running (Speed > 0)	(RUN)
1 (1001)	Frequency arrival signal	(FAR)
2 (1002)	Frequency detection	(FDT)
3 (1003)	Undervoltage detection	(LU)
5 (1005)	Torque limiting (Current limiting)	(IOL)
6 (1006)	Auto-restart after recovery from instantaneous power failure	(IPF)
7 (1007)	Motor overload early warning	(OL)
26 (1026)	Retry in operation	(TRY)
30 (1030)	Lifetime alarm	(LIFE)
35 (1035)	Inverter running	(RUN2)
36 (1036)	Overload prevention control	(OLP)
37 (1037)	Current detection	(ID)
41 (1041)	Low level current detection	(IDL)
99 (1099)	Alarm relay contact output (for any fault)	(ALM)

Terminal function assignment and data setting

- Inverter running (Speed > 0)--(RUN)
(Function code data = 0)

This output signal is used to tell the external equipment that the inverter is running with a speed greater than 0. It switches ON when the inverter output frequency exceeds the start frequency of the motor. It switches OFF when the output frequency is less than the start frequency or the inverter is DC-braking the motor.

 If this signal is assigned to terminal [Y1] in negative logic (active OFF), it can be used to indicate the inverter stopping its output.

■ Frequency arrival signal--(FAR)
(Function code data = 1)

This signal is turned ON when the difference between the output and set frequencies is within the allowable error zone (prefixed to 2.5 Hz).

■ Frequency detection--(FDT)
(Function code data = 2)

This signal is turned ON when the output frequency of inverter has come to the frequency detection level specified by function code E31. It is turned OFF when the output frequency drops lower than the detection level for 1 Hz (hysteresis band of the frequency comparator: prefixed at 1 Hz).

■ Undervoltage detection--(LU)
(Function code data = 3)

This signal is turned ON when the voltage of the DC link bus of the inverter drops below the specified level or when the motor stops due to activation of the undervoltage protection feature (undervoltage trip). It is turned OFF if the DC link bus voltage exceeds the specified voltage.

■ Torque limiting (Current limiting)--(IOL)
(Function code data = 5)

This signal is turned ON when the inverter is limiting the motor drive current by activating the current limiter of either software (F43: Function select, F44: Operation level) or hardware (H12 = 1: Current limit). The minimum ON-duration is 100 ms.

Using this signal allows the inverter to show an overload alarm on the display panel of the external equipment.

■ Auto-restart after recovery from instantaneous power failure--(IPF)
(Function code data = 6)

This signal is turned ON during the period from when the inverter detects the undervoltage of the DC link bus and shuts down the output (if auto-restart after a recovery from momentary power failure is selected (F14 = 4 or 5)) until auto-restarting (the output frequency has recovered up to the set frequency). At that moment of auto-restarting, this signal is turned OFF.

■ Motor overload early warning--(OL)
(Function code data = 7)

This signal is used to issue a motor overload early warning for enabling you to take corrective action before the inverter detects a motor overload (*OL1* alarm) and shuts down its output.

The motor properties are specified by function codes F10 and F12 (Motor characteristics selection and thermal time constant for electronic thermal overload protection). If a value calculated from the settings of F10 and F12 exceeds the detection level of the early warning set by function code E34, this signal is turned ON. Normally, the recommended set current level for E34 is 80 to 90% of the allowable continuous load current set by function code F11.



Function code E34 is effective for not only the motor overload early warning (OL), but also the current detection (ID) and low level current detection (IDL).

■ Retry in operation--(TRY)
(Function code data = 26)

This signal is turned ON when the retry facility specified by function codes H04 (number of retries) and H05 (retry interval) is being activated.



Refer to function codes H04 and H05 for details of the output timing and number of retries.

- Lifetime alarm--(LIFE)
(Function code data = 30)

This signal is turned ON when it is judged that the service life of any of capacitors (capacitor in the DC link bus and electrolytic capacitors on the printed circuit boards) and cooling fan has expired.

The judgement level for service life are as follows. This information can be checked in Menu #5 "Maintenance information" of Programming mode.

Parts	Judgement level for service life
Capacitor in the DC link bus	Capacitance: Max. 85% of factory default
Capacitor/s on the printed circuit boards	Accumulated run time: 61,000 hours or more
Cooling fan	Accumulated run time: 61,000 hours or more (2 to 5 HP models) (Based on the assumption that the inverter runs in an ambient temperature of 40°C (104°F))

This facility provides tentative information for service life of the parts. If this signal is issued, check the service life of these parts in your system according to the maintenance procedure to determine whether the parts should be replaced or not. To maintain stable and reliable operation and avoid unexpected failures, daily and periodic maintenance must be performed. For details, refer to the FRENIC-Mini Instruction Manual, Chapter 7 "MAINTENANCE AND INSPECTION."

- Inverter running--(RUN2)
(Function code data = 35)

This signal is turned ON when the main switching circuit (IGBT gates) is activated; it is OFF when it is not activated.

- Overload prevention control--(OLP)
(Function code data = 36)

This signal is turned ON when the overload prevention facility is activated if the frequency drop rate comes to be the setting specified by function code H70. The minimum ON-duration is 100 ms.

 For details of the overload prevention control, refer to the descriptions of function code H70.

- Current detection--(ID)
(Function code data = 37)

This signal is turned ON when the output current exceeds the operation level specified by function code E34 and stays in this status for the duration specified by function code E35 (on delay timer). The minimum ON-duration is 100 ms.

If the output current drops to 90% of the operation level, this signal is turned OFF.

This signal can be used as a reference for determining the running speed in the operation of load machinery or system, by monitoring the inverter's load state.

 **Note** Function codes E34 and E35 are effective not only for the current detection (ID), but often also for the overload early warning (OL) and low level current detection (IDL).

- Low level current detection--(IDL)
(Function code data = 41)

This signal is turned ON when the output current drops below the operation level specified by function code E34 and stays in this status for the duration specified by function code E35 (on delay timer).

If the output current exceeds the sum of the current level of operation and 5% of the rated current of the inverter, then this signal is turned OFF.

Use this signal to indicate 0A output current due to a broken output wire, zero motor torque, or any such factor undetectable by the inverter alarm facilities.

Note Function codes E34 and E35 are effective not only for the low level current detection (IDL), but often also for the overload early warning (OL) and current detection (ID).

- Alarm relay contact output (for any fault)--(ALM)
(Function code data = 99)

This signal is turned ON if the protection facility is activated so that the inverter enters Alarm mode.

In a system which monitors inverter alarm information through [30A/B/C] relay contacts, make sure that function code data of E20 or E27 is set to 99.

E31	Frequency Detection (FDT) (Detection level)
------------	--

Specifies an operating level for the set frequency detection signal. The hysteresis frequency band between detection and release levels is 1.0 Hz.

- Data setting range: 0.0 to 400.0 (Hz)

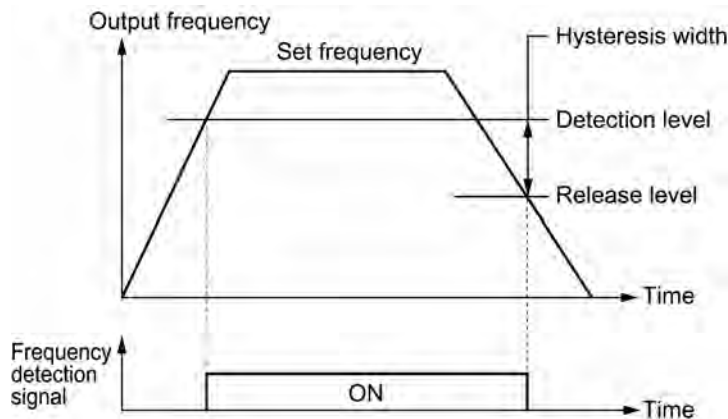

E34	Overload Early Warning/Current Detection/Low Current Detection (Level)
------------	---

E35	Current Detection/Low Current Detection (Timer)
------------	--

E34 and E35 set the operation level for overload early warning, current detection and low current detection, and the timer count.

- Operation Level (E34)

Sets the operation level for the motor overload early warning (OL), inverter output current detection (ID), or low current output detection (IDL).

- Data setting range: Current value of 1 to 200% of the rated inverter current in units of amperes.

- Timer (E35)

Sets the timer for the inverter output current detection (ID) and low current output detection (IDL).

- Data setting range: 0.01 to 600.00 (sec.)

E39	Coefficient for Constant Feeding Rate Time	Refer to E50.
------------	---	----------------------

E39 and E50 set a coefficient to be used for setting the constant feeding rate time, load shaft speed or line speed and for displaying its output status.

Data setting ranges and calculation equations

- Data setting range for E39: 0.000 to 9.999
for E50: 0.01 to 200.00

$$\text{Const. Feeding Rate Time (min)} = \frac{\text{Coeff. of Speed Indication (E50)}}{\text{Freq.} \times \text{Coeff. for Const. Feeding Rate Time (E39)}}$$

$$\text{Load Shaft Speed} = (\text{E50: Coeff. for Speed Indication}) \times \text{Frequency (Hz)}$$

$$\text{Line Speed} = (\text{E50: Coeff. for Speed Indication}) \times \text{Frequency (Hz)}$$

Where, Freq. is the set frequency if each expression is for one of the set data for the constant feeding rate time, load shaft speed, or line speed; it is the output frequency if each expression is for the output status monitor.

If the constant feeding rate time is 999.9 min or more, or the denominator on the right in the first equation is 0, then the number 999.9 will be displayed.

E40	PID Display Coefficient A
------------	----------------------------------

E41	PID Display Coefficient B
------------	----------------------------------

E40 or E41 sets the conversion factor to equal an indicated value (process amount) with the target and feedback values in PID control.

- Data setting range: -999 to 0.00 to 999 for conversion factors A and B.

Data setting and operation

- Target (commanded) and feedback values in PID control

Set the maximum and minimum PID indication values to function code E40 (factor A) and E41 (factor B), respectively. Calculate the indication value using the equation below.

$$\text{Indication value} = (\text{Target or feedback value}) \times (\text{Factor A} - \text{B}) + \text{B}$$

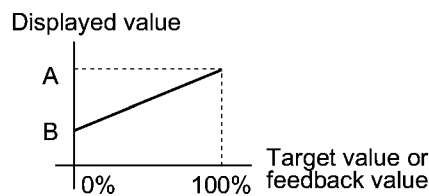

E43	Monitor Item Selection
------------	-------------------------------

Selects the monitoring item to be displayed on the LED monitor. When turning ON power to the inverter or after changing function code E43, the inverter will indicate the selected item on the LED monitor.

Data for E43	Function (Monitored items)
0	Speed monitor item (selected by the sub item of function code E48)
3	Inverter output current
4	Inverter output voltage
9	Inverter input power
10	PID command value*
12	PID feedback value*
13	Timer value**

* If 0 (Disable) is set for function code J01, "- - -" appears on the LED.
 ** If 0 (Disable) is set for function code C21, "- - -" appears on the LED.

E48	LED Monitor (Speed monitor item)
------------	---

Selects the speed-monitoring format on the LED monitor.

Data for E48	The LED monitor displays the sub item:
0	Output frequency before slip compensation
1	Output frequency after slip compensation
2	Set frequency
4	Load shaft speed in r/min
5	Line speed in m/min
6	Constant feeding rate time

E50	Coefficient for Speed Indication	Refer to E39.
------------	---	----------------------

Detail for the speed display coefficient setting is given in the description of function code E39.

E52	Menu Display Mode for Keypad
------------	-------------------------------------

Selects the menu display mode for the keypad in Programming mode.

Data for E52	The keypad will enter:
0	Function code data setting mode in which Menu #1 "Data setting" only is displayed.
1	Function code data check mode in which Menu #2 "Data checking" only is displayed.
2	Full-menu mode in which all menus may be displayed.

E60	Built-in Potentiometer (Function selection)
------------	--

E61	Analog Input Signal Definition for [12]
------------	--

E62	Analog Input Signal Definition for [C1]
------------	--

E60, E61, and E62 define the function of the built-in potentiometer, terminals [12] and [C1], respectively.

Data for E60, E61, or E62	This function will be defined for potentiometer and terminals [12] and [C1]:
0	None
1	Auxiliary frequency command 1*
2	Auxiliary frequency command 2**
3	PID process command 1 (J02 setting is also required.)
5	PID feedback value (Not applicable to function code E60)

* This is an auxiliary frequency input to be added to frequency command 1, but never to frequency command 2. Frequency commands 1 and 2 are frequencies set by the means specified by F01 and C30, respectively. The set frequency can be switched between, for example, frequency command 1 added by the auxiliary frequency and the raw frequency 2 added by nothing, to drive the motor in the desired manner. For more details, refer to Chapter 4, Section 4.2 "Drive Frequency Command Generator."

** An auxiliary frequency input to be added to the set frequency. For example, the auxiliary frequency input to be added to the preset frequency used for the multistep frequency operation.

 If the same data is set to these function codes, the priority order will be:
E60 > E61 > E62

E98	Terminal Command Assignment to [FWD]	Refer to E01 to E03.
E99	Terminal Command Assignment to [REV]	Refer to E01 to E03.

For details on the command assignment to terminals [FWD] and [REV], refer to the descriptions for function codes E01 to E03.

9.2.3 C codes (Control functions of frequency)

C01 to C03	Jump Frequencies 1, 2 and 3
C04	Jump Frequency Band

These function codes enable the inverter to jump up to three different points on the output frequency in order to skip the resonance frequency caused by the motor drive frequency and natural frequency of the driven mechanism.

- During acceleration, the moment the set frequency reaches the bottom of the set jump frequency band, the inverter keeps the output at that bottom frequency until the output frequency reaches the upper limit and proceeds with the acceleration until the next set point is reached or set speed is reached.

During deceleration, the inverter processes the set jump frequency band in reverse to the acceleration curve. Refer to the left-hand figure below.

- When the set jump frequency bands overlap, the overlapped band is ignored, the inverter takes the lowest frequency within the overlapped bands as the bottom frequency and the highest as the peak. Refer to the right-hand figure below.

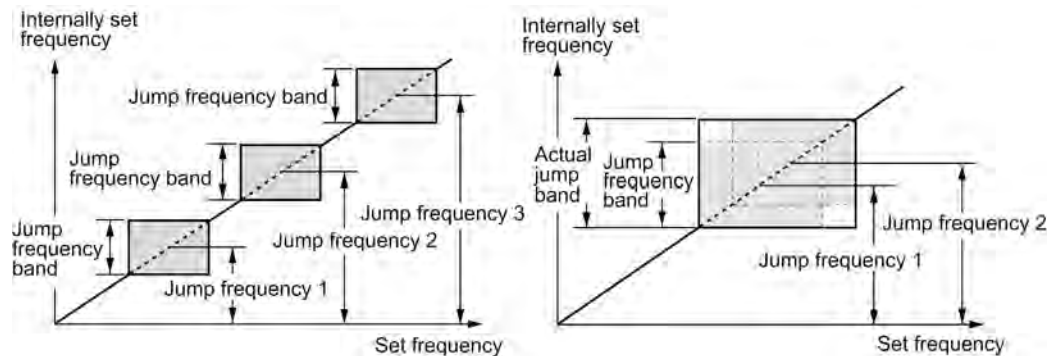

■ Jump frequencies 1,2 and 3 (C01, C02 and C03)

Set the center of the jump frequency band.

- Data setting range: 0.0 to 400.0 (Hz) (Setting to 0.0 results in no jump band)

■ Jump frequency band (C04)

Set the width of the jump frequency band.

- Data setting range: 0.0 to 30.0 (Hz) (Setting to 0.0 results in no jump band)

C05 to C11	Multistep Frequency Settings 1 to 7
-------------------	--

These function codes set frequencies required for driving the motor at frequencies 1 to 7.

- Data setting range: 0.00 to 400.00 (Hz)
- Turning terminal commands (SS1), (SS2) and (SS4) ON/OFF selectively switches the set frequency of the inverter in 7 steps. For details of the terminal function assignment, refer to the descriptions for function codes E01 to E03 "Command Assignment to Terminals [X1] to [X3]."

 For the multistep frequency driving, refer to Chapter 4, Section 4.2 "Drive Frequency Command Generator."

C20**Jogging Frequency**

Sets the frequency for jogging operations.

- Data setting range: 0.00 to 400.00 (Hz)



For details on jogging operations, refer to the descriptions for function codes E01 to E03 "Command Assignment to Terminals [X1] to [X3]."

C21**Timer Operation**

Enables or disables timer operation. If it is enabled, entering a run command will run the inverter to drive the motor for the period preset to the timer.

Data for C21	The timer operation is:
0	Disabled
1	Enabled

- Pressing the key during the timer countdown cancels the timer operation.
- If the timer has counted down to zero (0), pressing the key will not start the inverter to drive the motor even with C21 being set to 1.
- Timer operation can be started by turning ON the terminal command (FWD) or (REV).

An example of timer operation

Setting up the timer conditions beforehand

- Set C21 to 1 to enable timer operation.
- To display the timer count on the LED monitor, set function code E43 (LED monitor) to 13 (Timer count).
- Set up the frequency for the timer operation using the built-in potentiometer or the / key. If the LED displays the timer count, press the key to switch to the speed monitor and then set the frequency for the timer operation.

Timer operation (by giving a run command with the key)

- (1) Use the / key to set the timer count (in seconds) while monitoring the current count displayed on the LED monitor. Note that the timer count is expressed as integers.
- (2) Press the key to run the motor, and the timer will start the countdown. The moment the timer finishes the countdown, the inverter stops running the motor even if the key is not pressed. (Timer operation is possible even when the timer count is not displayed on the LED monitor.)



If timer operation started by the terminal command (FWD) is finished and the inverter decelerates the motor to a stop, then the LED monitor displays "End" and the monitor indication ("0" if the timer count is selected) alternately. Turning (FWD) OFF will switch the LED back to the monitor indication.

C30	Frequency Command 2	(Refer to F01.)
------------	----------------------------	------------------------

For details on frequency command 2, refer to the description for function code F01.

C32	Analog Input Adjustment (Gain for terminal input [12])	(Refer to F18.)
------------	---	------------------------

C34	Analog Input Adjustment (Gain reference point for terminal input [12])	(Refer to F18.)
------------	---	------------------------

C37	Analog Input Adjustment (Gain for terminal input [C1])	(Refer to F18.)
------------	---	------------------------

C39	Analog Input Adjustment (Gain reference point for terminal input [C1])	(Refer to F18.)
------------	---	------------------------

For details on adjusting the analog inputs, refer to the description for function code F18.

C33	Analog Input Adjustment (Filter for terminal input [12])
------------	---

C38	Analog Input Adjustment (Filter for terminal input [C1])
------------	---

C33 (voltage input) and C38 (current input) set the time constant of the filter for the analog input on terminal [12] and [C1], respectively.

- Data setting range: 0.00 to 5.00 (sec.)
- The larger the time constant, the slower the response. Set the time constant suitable to the load with consideration given to the system response. When the analog input fluctuates due to electric noise, first remove the noise factor or protect the input from noise by electric means (grounding the shield, ferrite core or capacitor). After that, increase the time constant if you cannot remove the noise factor to a sufficiently degree.

C50	Bias (Bias reference point for frequency command 1)	(Refer to F18.)
------------	--	------------------------

For details of setting the bias reference point for frequency command 1, refer to the descriptions of function code F18.

C51	Bias (Bias for PID command 1)
------------	--------------------------------------

C52	Bias (Bias reference point for PID command 1)
------------	--

These function codes modify the analog input of the PID process command 1 by gain and bias, enabling defining the arbitrary relationship between the analog input and PID process command to be arbitrarily defined.

 The actual setting is the same as that of function code F18. For details, refer to the description of function code F18.

 Note that function codes C32, C34, C37 and C39 are shared by the drive frequency commands.

- Bias (C51)
 - Data setting range: -100.00 to 100.00 (%)
- Bias reference point (C52)
 - Data setting range: 0.00 to 100.00 (%)

9.2.4 P codes (Motor parameters)

P02**Motor Parameter (Rated capacity)**

Sets the nominal rated capacity that is denoted on the rating nameplate of the motor.

Data for P02	If the nominal rated capacity is:
0.01 to 10.00	0.01 to 10.00 kW when function code P99 is set to 0, 3 or 4.
0.01 to 10.00	0.01 to 10.00 HP when function code P99 is set to 1.

P03**Motor Parameter (Rated current)**

Sets the nominal rated current that is printed on the rating nameplate of the motor.

- Data setting range: 0.00 to 99.99 (Amp.)

P09**Motor Parameter (Slip compensation gain)**

Sets the gain to compensate for the motor slip frequency.

- Data setting range: 0.0 to 200.0 (%)

Compensation gains for the rated slip frequencies listed in the following table are ones for Fuji standard motors.

Typical rated slip frequencies for 100%

Rated capacity (HP)	Fuji standard 8-series motors (Hz)	Typical motors rated in HP (Hz)	Fuji standard 6-series motors (Hz)	Other motors (Hz)
0.1	1.77	2.50	1.77	1.77
1/8	1.77	2.50	1.77	1.77
1/4	2.33	2.50	2.33	2.33
1/2	2.40	2.50	2.40	2.40
1	2.33	2.50	2.33	2.33
2	2.00	2.50	2.00	2.00
3	1.80	1.77	1.80	1.80
5	1.93	1.50	1.93	1.93

The 230 V and 460 V of motors share the same data listed above.



To compensate slip of a motor correctly, the rated voltage (at base frequency) (F05) and P codes (Motor parameters) should be also set consistently.

P99**Motor Selection**

Selects the motor to be used.

Data for P99	To use:
0	Fuji standard motors (8-series)
1	GE motors
3	Fuji standard motors (6- series)
4	Other motors

In order to perform automatic control features such as the auto torque boost/auto energy saving and slip compensation or electronic thermal overload protection for the motor, the inverter invokes the rated values and properties of the motor. To match the drive properties between the inverter and motor, set the motor properties to this code and set function code H03 (Initialize data) to 2 to initialize the motor parameter. This action automatically updates the data of function codes P03 and P09 and the constants used inside the inverter.

When using a Fuji standard motor, select the data listed below according to the model.

- P99 = 0 for Fuji standard 8-series motors (current models)
- P99 = 3 for Fuji standard 6-series motors (conventional models)

For motors from other manufacturers or unknown models, set P99 to 4 (Other motors).







- If P99 is set to 4 (Other motors), the parameters of the Fuji standard 8-series motor will apply as an alternative.
- The inverter also supports motors rated by HP (horse power: typical in North America, P99 = 1).

9.2.5 H codes (High performance functions)

H03	Data Initialization
------------	----------------------------

Initializes the current function code settings to the factory defaults or initializes the motor constants (parameters).

Data for H03	Function	Setting procedure
0	Disables initialization (Settings made by the user manually will be retained.)	Simultaneous keying of  +  keys changes data in order of 0, 1, 2, and of  +  keys changes data in the reverse order. Pressing the  key will fix the set data.
1	Initializes all function code data to the factory defaults	
2	Initializes the P03 data (Rated current of the motor) and internally used constants to the motor constants determined by P02 data (Motor capacity) and P99 (Motor characteristics), as listed on the next page. Initializes P09 data (Slip compensation gain) to 0.0.	

- If you do initialization while H03 is set at "1" or "2," H03 will automatically go back to "0" (factory default) at the completion of initialization.

<Procedure for initializing motor constants>

- To initialize the motor constants, set the related function codes as follows.
 - 1) P02 Motor Parameters: Set the rated capacity of the motor to be used in kW. (Rated capacity)
 - 2) P99 Motor Selection: Select the characteristics of the motor. (Refer to the descriptions given for P99.)
 - 3) H03 Data Initialization: Initialize the motor constants. (H03=2)
 - 4) P03 Motor Parameters: Set the rated current printed on the nameplate if the set data (Rated current) differs from the rated current.
- If any value out of the general motor capacity is set for P02, the capacity will be internally converted to the applicable motor rating (see the table on the next page).

- If P99 (Motor selection) is set to 0 (Fuji standard 8-series motors), 3 (Fuji standard 6-series motors), or 4 (Other motors):

Power supply voltage	Setting range (kW)	Applicable motor rating (kW)	Rated current (A)								
			If P99 (Motor selection) is set to:								
	0			3			4				
	Shipping destination (Version)			Shipping destination (Version)			Shipping destination (Version)				
Function code P02			Asia	EU	Japan	Asia	EU	Japan	Asia	EU	Japan
Three-phase 230V Single-phase 230V	0.01 to 0.06	0.06	0.40	0.44	0.38	0.40	0.44	0.38	0.40	0.44	0.38
	0.07 to 0.10	0.1	0.62	0.68	0.61	0.62	0.68	0.61	0.62	0.68	0.61
	0.11 to 0.20	0.2	1.18	1.30	1.16	1.19	1.30	1.18	1.18	1.30	1.16
	0.21 to 0.40	0.4	2.10	2.30	2.13	2.10	2.30	2.13	2.10	2.30	2.13
	0.41 to 0.75	0.75	3.29	3.60	3.36	3.29	3.60	3.36	3.29	3.60	3.36
	0.76 to 1.50	1.5	5.55	6.10	5.87	5.55	6.10	5.87	5.55	6.10	5.87
	1.51 to 2.20	2.2	8.39	9.20	8.80	8.39	9.20	8.80	8.39	9.20	8.80
	2.21 to 3.70	3.7	13.67	15.00	14.38	13.67	15.00	14.38	13.67	15.00	14.38
	3.71 to 5.50	5.5	20.04	22.00	21.19	20.04	22.00	21.19	20.04	22.00	21.19
	5.51 to 10.00	7.5	26.41	29.00	28.17	26.41	29.00	28.17	26.41	29.00	28.17
Three-phase 460V	0.01 to 0.06	0.06	0.19	0.22	0.19	0.19	0.22	0.19	0.19	0.22	0.19
	0.07 to 0.10	0.1	0.31	0.34	0.31	0.31	0.34	0.31	0.31	0.34	0.31
	0.11 to 0.20	0.2	0.58	0.65	0.58	0.59	0.65	0.59	0.58	0.65	0.58
	0.21 to 0.40	0.4	1.09	1.15	1.07	1.09	1.15	1.07	1.09	1.15	1.07
	0.41 to 0.75	0.75	1.71	1.80	1.68	1.71	1.80	1.68	1.71	1.80	1.68
	0.76 to 1.50	1.5	3.04	3.05	2.94	3.04	3.05	2.94	3.04	3.05	2.94
	1.51 to 2.20	2.2	4.54	4.60	4.40	4.54	4.60	4.40	4.54	4.60	4.40
	2.21 to 3.70	3.7	7.43	7.50	7.20	7.43	7.50	7.20	7.43	7.50	7.20
	3.71 to 5.50	5.5	10.97	11.00	10.59	10.97	11.00	10.59	10.97	11.00	10.59
	5.51 to 10.00	7.5	14.63	14.50	14.08	14.63	14.50	14.08	14.63	14.50	14.08

NOTE: The above values in the "Rated current" column are exclusively applicable to the four-pole Fuji standard motors rated for 230 V and 460 V at 60 Hz. If you use non-standard or other manufacturer's motors, change the P02 data to the rated current printed on the motor's nameplate.

- If P99 (Motor selection) is set to 1 (HP motors):

Power supply voltage	Setting range (HP)	Applicable motor rating (HP)	Rated current (A)		
			If P99(Motor selection) is set to:		
	1				
	Function code P02		Shipping destination (Version)		
			Asia	EU	Japan
Three-phase 230V Single-phase 230V	0.01 to 0.10	0.1	0.44	0.44	0.44
	0.11 to 0.12	0.12	0.68	0.68	0.68
	0.13 to 0.25	0.25	1.40	1.40	1.40
	0.26 to 0.50	0.5	2.00	2.00	2.00
	0.51 to 1.00	1	3.00	3.00	3.00
	1.01 to 2.00	2	5.80	5.80	5.80
	2.01 to 3.00	3	7.90	7.90	7.90
	3.01 to 5.00	5	12.60	12.60	12.60
	5.01 to 7.50	7.5	18.60	18.60	18.60
	7.51 to 10.00	10	25.30	25.30	25.30
Three-phase 460V	0.01 to 0.10	0.1	0.22	0.22	0.22
	0.11 to 0.12	0.12	0.34	0.34	0.34
	0.13 to 0.25	0.25	0.70	0.70	0.70
	0.26 to 0.50	0.5	1.00	1.00	1.00
	0.51 to 1.00	1	1.50	1.50	1.50
	1.01 to 2.00	2	2.90	2.90	2.90
	2.01 to 3.00	3	4.00	4.00	4.00
	3.01 to 5.00	5	6.30	6.30	6.30
	5.01 to 7.50	7.5	9.30	9.30	9.30
	7.51 to 10.00	10	12.70	12.70	12.70

NOTE: The above values in the "Rated current" column are exclusively applicable to the four-pole Fuji standard motors rated for 230 V and 460 V at 60 Hz. If you use non-standard or other manufacturer's motors, change the P02 data to the rated current printed on the motor's nameplate.

H04	Retry (No. of retries)
------------	-------------------------------

H05	Retry (Latency time)
------------	-----------------------------

To automatically exit from the alarm status and restart the inverter, use the retry functions. In doing so, the inverter automatically exits from Alarm mode and restarts without issuing a block alarm even if it has entered the forced Alarm mode. If the inverter has entered Alarm mode during retry (specified by function code H04), it issues a block alarm and does not exit Alarm mode for restarting.

Listed below are the recoverable alarm statuses of the inverter.

Alarm Status	LED monitor display
Instantaneous overcurrent protection	<i>OC 1, OC2 or OC3</i>
Overvoltage protection	<i>OU 1, OU2 or OU3</i>
Heat sink overheated	<i>OH 1</i>
Motor overheated	<i>OH4</i>
Braking resistor overheated	<i>dbH</i>
Motor overloaded	<i>OL 1</i>
Inverter overloaded	<i>OLU</i>

Settings and operations

■ Retry times (H04)

Set the number of retry times for automatic exit from Alarm mode. If the inverter has entered Alarm mode during the retry times specified, the inverter issues a block alarm and does not exit alarm mode for restarting.

- Data setting range: 0 to 10 (times) (If 0 is set, the "retry" operation will not be activated.)

■ Retry latency time (H05)

- Data setting range: 0.5 to 20.0 (sec.)

Sets the latency time for automatic exit from Alarm mode. Refer to the timing scheme diagram below.

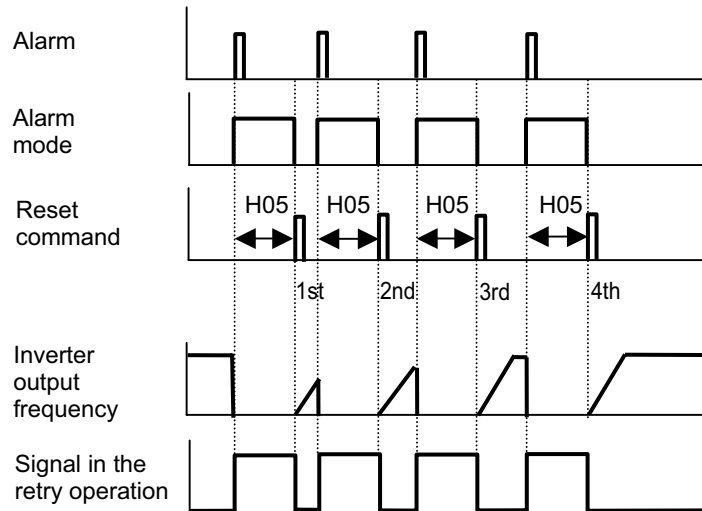

- The retry operation can be monitored by external equipment via the inverter's digital output on terminal [Y1] or [30A/B/C]. Assign (TRY) to these terminals by setting "26" to function code E20 or E27.

H06

Cooling Fan ON/OFF

Stops the built-in cooling fan and monitoring the temperature inside the inverter when the inverter is idling, in order to extend the service life of the cooling fan and reduce running noise.

Note that as turning the cooling fan on/off too frequently may shorten the service life, leave the fan running for 10 minutes or longer each time it is turned on.

Function code H06 selects whether the cooling fan runs constantly or selectively.

Data for H06	Function
0	Disable (cooling fan runs constantly)
1	Enable (cooling fan is turned on/off as required)

Specifies the acceleration and deceleration patterns (output frequency patterns).

Data for H07	Function
0	Disable: Linear
1	S-curve (weak)
2	S-curve (strong)
3	Curvilinear

Linear acceleration/deceleration

The inverter runs the motor with the constant acceleration and deceleration.

S-curved acceleration/deceleration

To reduce the impact on the inverter driven motor during acceleration/deceleration, the inverter gradually accelerates/decelerates the motor during both the acceleration/ deceleration zones.

Two frequencies can be selected for S-curved acceleration/deceleration 5% (weak) or 10% (strong) of the maximum output frequency. The four centers of S-curves are not affected by this selection. Note the set acceleration/deceleration time defines the linear acceleration/ deceleration in the zones, so that the actual zone exceeds the set zone in this case. Zones are defined in units of time. Refer to the figure at the right.

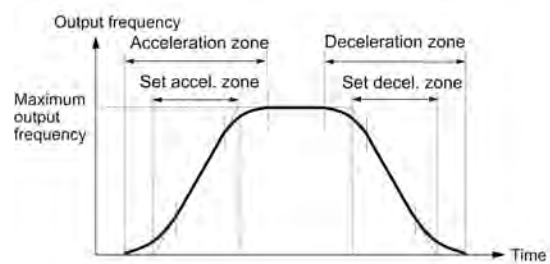

Curvilinear acceleration/deceleration

The inverter drives the motor to output the maximum performance, with the following acceleration/deceleration pat-terns:

- In the zone under the base frequency, linear acceleration/deceleration of constant torque output for the motor
- In the zone above the base frequency, speed two times the base frequency and acceleration/deceleration half of the base frequency

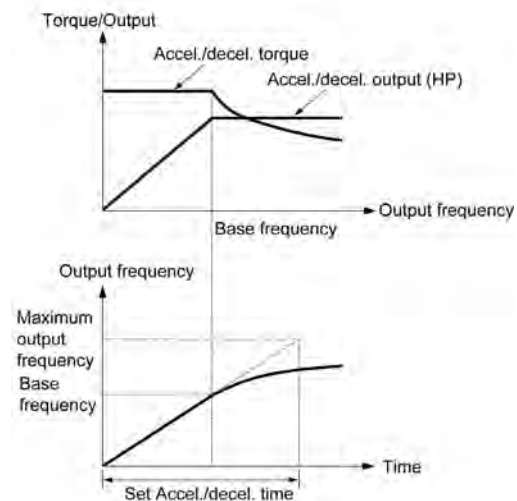

Set the acceleration/deceleration time giving due consideration to the load torque. Refer to Chapter 7 "SELECTING OPTIMAL MOTOR AND INVERTER CAPACITIES" for details.

H12 Instantaneous Overcurrent Limiting

The inverter features a hardware-controlled output current limiter to protect it from an overload hazard. The moment that the output current exceeds the limited level due to overload or other factor, the inverter controls the output switching circuits so as to slow down the output frequency and suppress the output current momentarily.

Data for H12	Function
0	Disable
1	Enable

This control of the switching circuits may cause an instantaneous reduction in motor output torque. However, instantaneous torque reduction may not be allowable in some systems when the system is in a short time overloaded state. To solve this problem, this function should be disabled and the system set up with a proper facility that is activated by the alarm output from the inverter when it detects an overcurrent.

Note The same functions to limit the output current are implemented by software as function codes F43 and F44. Generally, software features have an operation delay, so enable function code H12 as well.

Depending upon the load, acceleration in an extremely short period may activate the current limiter to suppress the increase of the inverter output frequency, causing the system oscillate (hunting) or making the inverter enter the *OU* Alarm mode and trip. When setting the acceleration time, therefore, you need to take into account the load condition and moment of inertia. Refer to Chapter 7, Section 7.1, "Selecting Motors and Inverters."

H26 Thermistor Input (Selection)

H27 Thermistor Input (Operation level)

Set these function codes to protect the motor from an overheat hazard using the PTC (Positive Temperature Coefficient) thermistor embedded in the motor.

■ Thermistor (Select) (H26)

Enables or disables overheating protection for the motor using the PTC thermistor, which senses motor temperature.

Data for H26	Function
0	Disable overheating protection
1	Enable overheating protection

■ Thermistor (Operation Level) (H27)

Determines the operation level for the overheating protection.

- Data setting range: 0.00 to 5.00 (V)

Connect the PTC thermistor as shown in the figure at the right. The input current from terminal [C1] flows across the resistor R_2 and yields the voltage. If the voltage exceeds the operation level set by function code H27, the overheating protection is activated, and the inverter enters Alarm mode and issues the alarm "OH" (motor protection).

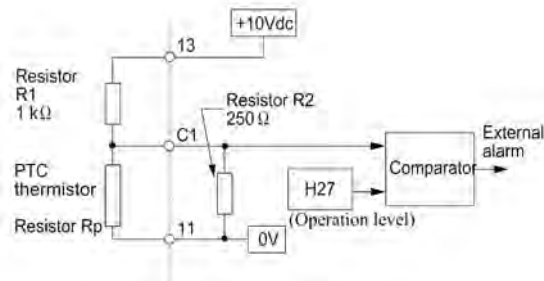

The temperature at which the overheating protection is to be activated depends on the characteristics of the PTC thermistor. As shown at the right, the internal resistance of the thermistor will step up near the alarm temperature detection point. Determine the operation level (voltage V_{c1}) with reference based on the variance in internal resistance.

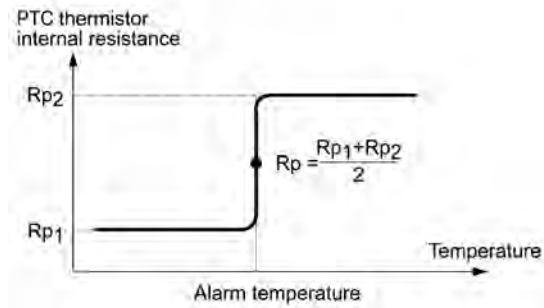

Calculate the reference voltage V_{c1} using the equation shown below and set it to function code H27.

Substitute the internal resistance of the PTC thermistor at the alarm temperature with R_p to obtain V_{c1} :

$$V_{c1} = \frac{\frac{250 \cdot R_p}{250 + R_p}}{R_1 + \frac{250 \cdot R_p}{250 + R_p}} \times 10 \text{ (V)}$$

H30**Communications Link (Function selection)**

This function enables the inverter to be managed (i.e. to monitor the operation status or data set in the function codes, to set the drive frequency and to manage the operation commands) from a personal computer or PLC via RS-485 communication. To select information in the inverter that is to be accessible via RS-485 communication, set each data to function code H30 as shown in the table below. "N" represents information that cannot be accessed via RS-485 communication, but by commands from the terminals.

 Refer to Chapter 4 "BLOCK DIAGRAMS FOR CONTROL LOGIC" and the RS-485 Communication User's Manual for details.

Data for H30	Function			Remarks
	Monitoring	Frequency setting	Operation command	
0	Y	N	N	Y: Possible N: Not possible
1	Y	Y	N	
2	Y	N	Y	
3	Y	Y	Y	

- Assign the terminal command (LE) to one of terminals [X1] to [X3] using function codes E01 to E03 to enable/disable the function specified by code H30 by terminal command, and short-circuit between the terminal assigned for (LE) command and [CM]. To disable the function, open the circuit ((LE) = OFF). When (LE) is set to OFF, the inverter enters the operation mode where the commands and frequencies given by the terminals or keypad are effective.

H42**Capacity of DC Link Bus Capacitor**

This function code is used to clear the information related to the DC link bus capacitor if it is replaced. Follow the instructions for replacement.

H43**Accumulated Run Time of Cooling Fan**

This function code is used to clear the information related to the cooling fan if it is replaced. Follow the instruction for the replacement.

H50	Non-linear V/f Pattern (Frequency)	Refer to F04.
------------	---	----------------------

H51	Non-linear V/f Pattern (Voltage)	Refer to F04.
------------	---	----------------------

For details of setting the non-linear V/f pattern, refer to the descriptions of function code F04.

H54	ACC/DEC Time (Jogging operation)
------------	---

Sets both the acceleration and deceleration time for jogging operations.

- Data setting range: 0.00 to 3600 (sec.)



Refer to function codes E01 to E03 “Terminal assignment of [X1] to [X3] for details on jogging operations.

H64	Low Limiter (Min. freq. when limiter is activated)
------------	---

When the output current limiter and/or overload-suppressing feature is activated, this function limits the bottom of the frequency that may vary due to reaction of the limit control.

- Data setting range: 0.0 to 60.0 (Hz)

H69	Automatic Deceleration (Regenerative energy suppressing)
------------	---

Enables regenerative energy suppressing control.

Data for H69	Function
0	Disable
1	Enable

The moment that a regenerative energy exceeding the capacity of the inverter is returned when braking is being applied to the motor, the inverter will shut its output down and enter overvoltage alarm mode. If regenerative energy suppressing control is enabled, the inverter lengthens the deceleration time to 3 times that of the set time while the DC link bus voltage exceeds the preset voltage suppressing level, and decreases the deceleration torque to 1/3. In this way, the inverter makes the motor reduce the regenerative energy tentatively.

This control is used to suppress torque generated by the motor in deceleration. Conversely, when the load on the motor results in a braking effect, the control does not have any effect, so do not use it in this case. In addition, note that setting an extremely short deceleration time may cause an overvoltage alarm failure of the inverter even if the time is multiplied by 3 – keep this in mind when setting deceleration time.

Disable this function when the inverter features a braking resistor. If it is enabled, the braking resistor and regenerative energy suppressing control may conflict with each other, which may change the deceleration time unexpectedly.

H70**Overload Prevention Control (Frequency drop rate)**

Enables overload suppressing control. If enabled, this function code is used to set the deceleration (Hz/s).

Before the inverter enters Alarm mode due to heat sink overheat or overload (alarm code: *OH1* or *OL1*), this control decreases the output frequency of the inverter to suppress the trip.

Data for H70	Function
0.00	Decelerate by deceleration time 1 (F08) or 2 (E11).
0.01 to 100.0	Decelerate by 0.01 to 100.0 Hz/sec.
999	Disable overload suppression control

- When overload suppressing control is enabled, the inverter decelerates the motor according to the set deceleration rate if the temperature anywhere inside the inverter exceeds the alarm detection level.
- Apply this control to equipment (such as pumps) whose drive frequency drops in line with any decrease in load. If you want to proceed to drive such kind of equipment even the inverter slows down the output frequency, enable this control.



- Do not use this function to equipment whose load does not slow if the inverter output frequency drops, as it will have no effect.
- To avoid any conflict between overload suppressing control and any other frequency lowering features, this control does not function if the features to limit the output current are enabled (F43 ≠ 0 and H12 = 1). To force this control to enabled status, set 0 for function codes F43 and H12.

H80**Gain for Suppression of Output Current Fluctuation**

The inverter output current driving the motor may fluctuate due to the motor characteristics and/or backlash in the load mechanism. Modify the data in function code H80 to adjust the amount in order to suppress such fluctuation. However, as incorrect setting of this amount may cause a much larger current fluctuation, do not modify the default setting unless it is necessary.

- Data setting range: 0.00 to 0.20

H89**Motor overload memory retention**

This is Motor overload memory (Electrical thermal O/L relay) retention selection at power up.

Data for H89	Function
0	Inactive When power up the drive, Motor overload data is reset.
1	Active. When power is down, the drive stores Motor overload data and use this data at next power up.

H95**DC Braking (Braking mode)****Refer to F21.**

For details of setting the braking mode, refer to the descriptions of function code F21.

H96**STOP Key Priority/Start Check Function**

The inverter can be operated using a functional combination of "STOP key priority" and "Start check function."

Data for H96	STOP key priority	Start check function
0	Disable	Disable
1	Enable	Disable
2	Disable	Enable
3	Enable	Enable

STOP key priority

When the drive commands are received from the terminals and via RS-485 communication, pressing the  key forces the inverter to decelerate and stop the motor. "E-r-E" is displayed on the LED after stopping.

Start check function

For safety, this function checks whether any run command has been switched on or not. If a run command has been switched on, "E-r-E" is displayed on the LED without the inverter being started up. This occurs in the following situations:

- (1) When any run command is switched on when the power to the inverter switched on.
- (2) When the  key is pressed to release the alarm status caused by the protective function, or the reset alarm command (RST) is switched on while any run command is input.
- (3) When the run command source has been switched by the link command (LE), which selects whether to enable or disable communications, when a run command is being input at the source that being switched to.

H97**Clear Alarm Data**

Clears all alarm information (e.g. historical records and information at time the alarm occurred) to return the inverter to default status (factory settings).

Data for H97	Function
0	Disable
1	Clear (data automatically reset to 0)

H98**Protection/Maintenance Functions (Selection)****Refer to F26.**

Specifies a combination between the output phase loss protection, input phase loss protection and lowering of automatic carrier frequency.

Data for H98	Output phase loss	Input phase loss	Automatic lowering of carrier frequency
0	Disable	Disable	Disable
1	Disable	Disable	Enable
2	Disable	Enable	Disable
3	Disable	Enable	Enable
4	Enable	Disable	Disable
5	Enable	Disable	Enable
6	Enable	Enable	Disable
7	Enable	Enable	Enable

Output phase loss protection (\overline{OPL})

The inverter will enter Alarm mode activated by the output phase loss protection, and issue the alarm OPL if it detects an output phase loss while it is running.

If a magnetic contactor that has been inserted in the inverter output circuits switches off when the inverter is running, this protection will not be activated.

Input phase loss protection (\overline{IPL})

The inverter will enter Alarm mode and issue an alarm (\overline{IPL}) if a phase loss is detected in the three-phase input power source.

Do not enable this protection with inverters with single-phase input, as it is not effective.

When operating an inverter with a three-phase input with a single phase for testing purposes, this protection may be disabled, but only if the load can be reduced.

Automatic lowering of carrier frequency

When using an inverter in a critical system or any other systems where inverter operation should not be interrupted, select this feature to protect the system from failures which could result from the inverter tripping due to the heat sink overheating (\overline{HS}) or overload (\overline{OL}), abnormally high ambient temperature or a cooling mechanism failure. This feature lowers the output frequency before the inverter enters Alarm mode, however, the level of motor noise may increase.

9.2.6 J codes (Application functions)

J01	PID Control (Selection)
J02	PID Control (Remote process command)
J03	PID Control (Gain)
J04	PID Control (Integration time)
J05	PID Control (Differential time)
J06	PID Control (Feedback filter)

The PID control is a closed loop feed back system that regulates control amounts with command values, as shown in the schematic block diagram below. Essentially, the system employs a sensor or similar device and compares it with the commanded amount (e.g. a temperature control command). If there is any difference between them, the system reacts so as to minimize it.

Apply the PID control system to process control mechanisms for flow-rate, pressure, temperature and the like.

If PID control is enabled (J01 = 1 or 2), the frequency block diagram changes to the PID control block diagram.

Refer to Chapter 4, section 4.8 "PID Frequency Command Generator" for details.

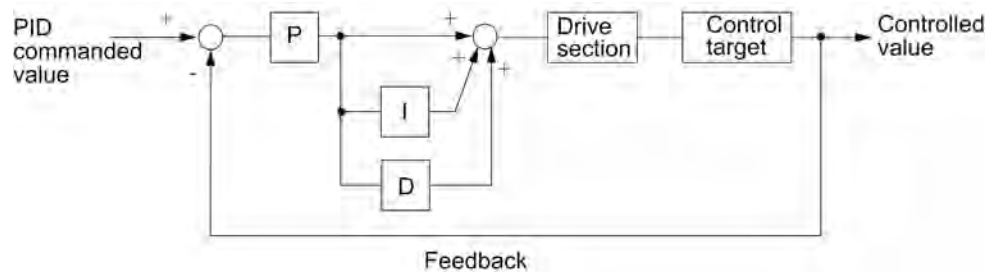

◆ PID Control Selection (J01)

Selects PID control status.

Data for J01	PID control
0	Disable
1	Enable process control (normal operation)
2	Enable process control (inverse operation)

- This function allows inserting the difference (error) between PID command and amount that have been fed-back so as to drive the motor for normal or inverse operation. Apply this control to a system increasing/decreasing the motor speed according to any such difference, such that occurring when an air conditioner is switched between cooling and heating. The operation mode can also be switched between normal and inverse using the terminal command (IVS).



Refer to function codes E01 to E03 for details of assignment of the terminal command (IVS).

■ Remote process command (J02)

Selects the means by which the PID control command can be set.

Data for J02	Means
0	Keypad
1	Built-in potentiometer, terminal [12] or [C1] for PID process command 1
4	Via RS-485 communication

If an analog command (built-in potentiometer, terminal [12] or [C1]) is selected as the PID process command, it is also necessary to select PID process command 1 for the analog input side using function codes E60, E61 and E62.



Refer to function codes E60 to E62 for details.



The multistep frequency C08 set by the terminal command (SS4) can also be used as a preset amount for the PID process command, in addition to that of function code J02.

Calculate the setting data of the process command using the equation below.

$$\text{Process command data (\%)} = \text{set multistep frequency} \div \text{maximum output frequency} \times 100$$

Selecting feedback

Select either analog input terminal [12] or [C1] for the PID control feedback signal terminal.



Refer to function codes E60 to E62 for details.

Conversion factor for indication and monitoring of PID value

To monitor the PID process command and its feedback, set the conversion factor used for transformation between the PID control amount (such as temperature) and numerals expressing the value.



Refer to function codes E40 and E41 for details on the conversion factor, and to E43 for details on monitoring.

Gain and bias settings for the PID command

As with the drive frequency command, gain and bias can be set for the PID command.



Refer to function codes C51 and C52 for details.

■ Gain (J03)

Sets the gain for the PID processor.

- Data setting range: 0.000 to 10.00 × (times)

P (Proportional) control

An operation using an output frequency proportional to deviation is called P operation, which outputs an operational amount proportional to deviation, through it cannot eliminate deviation alone.

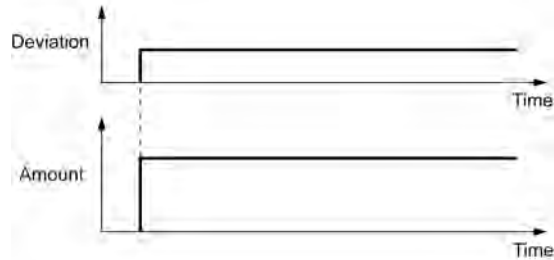

Gain determines the system response level for the deviation in the P control. An increase in gain speeds up response, an excessive gain can cause vibration, and a decrease in gain delays response.

■ Integration time (J04)

Sets the integration time for the PID processor.

- Data setting range: 0.0 to 3600.0 (sec.)

I (Integral) control

The PID operation having the proportional relationship of deviation between the commanded (frequency) rate (Hz/s) and control amounts is called the I control. The I control outputs the control amount proportional to the integral amount of the deviation. Therefore, it is effective for making the feedback value consistent with the commanded one (such as frequency). For the system whose deviation of response rapidly changes, however, this control cannot make the system react quickly.

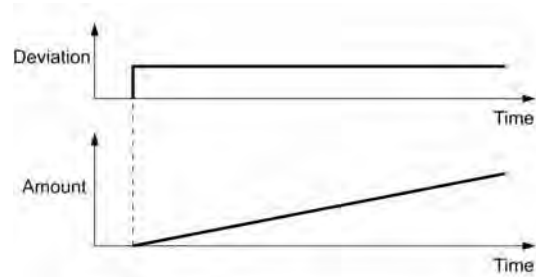

The effectiveness of I control is expressed by a parameter of integration time. The longer the integration time, the slower the response. The reaction force of the system to an external stimulus force becomes weak. The shorter integration time the faster response. Setting too short integration time, however, makes the system tend to oscillate.

■ Differentiation time (J05)

Sets the differentiation time for the PID processor.

- Data setting range: 0.00 to 600.00 (sec.)

D (Derivative) control

The PID operation having the proportional relationship of deviation between derivative of the commanded (frequency) and control amounts is called the D control. The D control outputs derivative of the control amount. For rapidly change, this control makes the system react quickly.

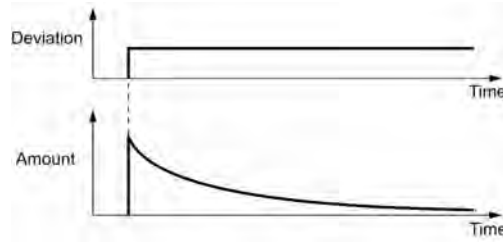

The effectiveness of ID control is expressed by a parameter of differentiation time. Setting a long differentiation time will quickly converge on a system control error (deviation) caused by P control. Setting it too long makes the system tend to oscillate more. Setting it too short will suppress the convergent effect to the deviation caused by the system operation.

Descriptions combined use of P, I and D control are shown below.

(1) PI control

PI control, which is a combination of P and I control, is generally used to minimize the deviation caused by P control. PI control acts to minimize at all times the deviation caused by a variance of the commanded amount or external disturbance to the system as stationary events. However, the longer integration time set, the slower the system response.

Use P control alone for loads with integral component ratio that takes very large part of control amount.

(2) PD control

When PD control is applied to a system, the moment that a deviation occurs, the system instantaneously generates a control amount much greater than that of D control (frequency) to suppress the deviation. If the deviation converges, the P control amount may decrease.

A load including the integral component in the equipment to be controlled may oscillate from the action of the integral component if the P control alone is applied. In this case, use PD control to reduce the oscillation caused by P control for keeping the system stable. That is, PD control should be applied to any system that does not contain any braking actions in its process.

(3) PID control

PID control is implemented by combining P control with the deviation suppression of I control and the oscillation suppression of D control. PID control features minimal control deviation, high precision and high stability.

In particular, applying PID control to any system that has a long response time to the occurrence of deviation will yield excellent results.

Follow the procedure below to set PID data.

It is highly recommended that the PID control amount is selected and set while monitoring the system response waveform with an oscilloscope or equivalent. Repeat following procedure to identify the optimal solution for each system.

- Increase the data to be set to function code J03 (PID gain) in the range where the feedback signal does not oscillate.
- Decrease the data to be set to function code J04 (PID integration time) in the range where the feedback signal does not oscillate.
- Increase the data to be set to function code J05 (PID differentiation time) in the range where the feedback signal does not oscillate.

Refining the system response waveforms is shown below.

1) Suppressing overshoot

Increase the data value of function code J04 (integration time) and decrease that for code J05 (differentiation time)

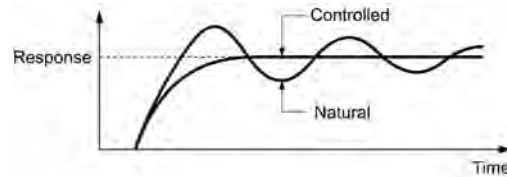

2) Quick stabilizing (small overshoot allowable)

Decrease the data value of function code J03 (gain) and increase that for code J05 (differentiation time)

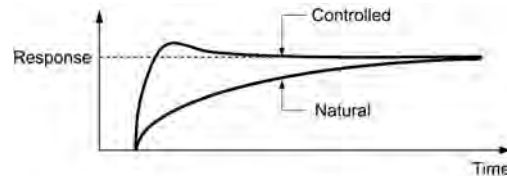

3) Suppressing oscillation longer than the integration time set by function code J04

Increase the data value set to function code J04 (integration time)

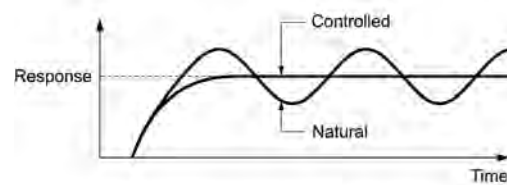

4) Suppressing oscillation of approximately same period as the time set for function code J05 (differentiation time)

Decrease the data value set for function code J05 (differentiation time).

Decrease the data value set for function code J03 (gain), even if the differentiation time is set at 0 sec.

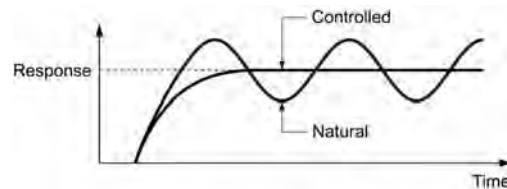

■ Feedback filter (J06)

Sets the time constant of the filter for PID feedback signals.

- Data setting range: 0.0 to 900.0 (sec.)
- This setting is used to stabilize the PID control loop. Setting too long a time constant makes the system response slow.

9.2.7 y codes (Link functions)

Mounting an RS-485 communications card (option) on the FRENIC-Mini series enables performing the operations listed below via the RS-485 communications facility.

(1) Using the remote keypad (option)

The remote keypad (option) allows running inverter and monitoring the running status information to be monitored from remote locations, such as from the outside of the power control panel.

(2) FRENIC Loader

Monitoring the running status information, editing function codes and test-running the inverters can be performed on a Windows-based PC connected to the power system network (including the inverter/s) by installing FRENIC Loader (software).



Setting data to the y codes, refers to function codes y01 to y10.

(3) Host controller

The inverter can be managed and monitored by connecting a host controller such as a PLC to the power system network. Available communications protocols are the Modbus RTU* and Fuji general-purpose inverter protocol.

* Modbus RTU is a protocol established by Modicon, Inc.



Refer to the RS-485 Communication User's Manual for details.

y01 to y10

Link Functions for RS-485 Communication

■ Station Address (y01)

Sets the station address for the communications network. The table below lists the relation between the data setting range and the protocol.

Protocol	Station address	Broadcast address
Modbus RTU	1 to 247	0
FRENIC Loader	1 to 255	None
Fuji general-purpose inverter	1 to 31	99

- If the address is set outside of the range specified in the table above, no response will be returned as the inverter will be unable to receive any enquiries.
- Settings for FRENIC Loader: Set the same address as that specified in the connected PC.

■ Communications error processing (y02)

Specifies the error processing operation for RS-485 communication.

Data for y02	The inverter will:
0	Immediately enter Alarm mode, issue RS-485 communications error $E_r\text{-}\overline{E}$ and shut down its output.
1	Continue to run for the period preset by the timer, then enter Alarm mode, issue RS-485 communications error $E_r\text{-}\overline{E}$, and shut down its output.
2	Retry to receive/send the query/response during the period preset by the timer. If communications have not recovered, the inverter will enter Alarm mode, issue RS-485 communications error $E_r\text{-}\overline{E}$ and shut down its output. If communications have recovered, the inverter will continue to run.
3	Continue to run even if a communications error occurs.

- Setting for FRENIC Loader: If the connected PC runs out during test-running of the inverter, no stop command may be able to be sent to stop the inverter. For safety, select the setting for this function code so as to prevent this happening.

■ Error processing timer (y03)

Sets the error processing timer (for waiting time)

- Data setting range: 0.0 to 60.0 (sec.)

■ Transmission speed (y04)

Selects the transmission speed for RS-485 communication.

- Setting for FRENIC Loader: Set the same transmission speed as that specified for the connected PC.

Data for y04	Transmission speed
0	2400 bps
1	4800 bps
2	9600 bps
3	19200 bps

■ Transmission data length (y05)

Select the character data for transmission.

- Setting for FRENIC Loader: The loader will set the length in 8 bits automatically. (The same applies to the Modbus RTU.)

Data for y05	Data length
0	8 bits
1	7 bits

■ Parity check (y06)

Select the property of the parity bit.

- Setting for FRENIC Loader: The loader automatically sets it to the even parity.

Data for y06	Parity
0	No parity bit
1	Even parity
2	Odd parity

■ Stop bits (y07)

Select the number of stop bits.

- Setting for FRENIC Loader: The loader automatically sets it to 1 bit.

The Modbus RTU protocol automatically determines number of the parity bits associated with its parity bit property so no setting is required.

Data for y07	Stop bits
0	2 bits
1	1 bit

■ No-response error detection time (y08)

Sets the time interval from the inverter detecting no access until it enters communications error E_r alarm mode due to network failure.

Data for y08	Function
0	Disable
1 to 60	1 to 60 sec.

- Setting for FRENIC Loader: As communication between loader software and inverters is classified into two categories--periodic access and event-driven access, depending on the selected facility, disable communications error detection (y08 = 0). When test running, the access period is to be 800 ms, however, it may vary depending on the operating system running on the PC and/or its processing status.

■ Response latency time (y09)

Sets the latency time from the end of receiving a query sent from the host (such as the PC or PLC) to the start of sending the response. This function allows using equipment whose response time is slow for a network requiring quick response.

- Data setting range: 0.00 to 1.00 (sec.)

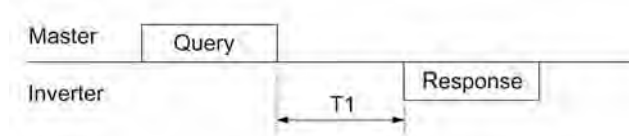

$$T1 = \text{Latency time} + \alpha$$

where α is the processing time of the inverter (may vary depending upon the processing status and the run command in the inverter).

 Refer to the RS-485 Communication User's Manual.

- Setting for FRENIC Loader: Set the correct data to the function code depending on the performance and/or configuration of the PC and protocol converter (such as RS-485/RS-232C). Note that some protocol converters monitor the communications status and switch the send/receive of transmission data by timer.

■ Protocol selection (y10)

Selects the communications protocol.

- Setting for FRENIC Loader: Select the loader protocol (y10 = 1).

Data for y10	Protocol
0	Modbus RTU
1	FRENIC Loader
2	Fuji general-purpose inverter

y99**Link Function for Supporting Data Input**

This function code switches an RS-485 communications link with FRENIC Loader. Enabling the RS-485 communications link allows the inverter to receive frequency and run commands from the Loader.

Since the Loader automatically sets data of function codes, no setting with the keypad is required.

If the PC runs out of control in RS-485 communication, a stop command may not be sent to the inverter. To prevent this from happening, set 0 to y99 so that the inverter will follow the settings of function code H30.

Note that the inverter cannot save the data setting in y99. Turning the power off resets the data in y99 to 0.

Data for y99	Function	
	Frequency command source	Run command source
0	Setting of H30	Setting of H30
1	Loader (S01 and S05)	Setting of H30
2	Setting of H30	Loader (S06)
3	Loader (S01 and S05)	Loader (S06)

Appendices

Contents

App.A	Advantageous Use of Inverters (Notes on electrical noise)	1
A.1	Effect of inverters on other devices	1
A.2	Noise	2
A.3	Noise prevention	4
App.B	Japanese Guideline for Suppressing Harmonics by Customers Receiving High Voltage or Special High Voltage	12
B.1	Application to general-purpose inverters	12
B.2	Compliance to the harmonic suppression for customers receiving high voltage or special high voltage	13
App.C	Effect on Insulation of General-purpose Motors Driven with 460 V Class Inverters	17
C.1	Generating mechanism of surge voltages	17
C.2	Effect of surge voltages	18
C.3	Countermeasures against surge voltages	18
C.4	Regarding existing equipment	19
App.D	Inverter Generating Loss	20
App.E	Conversion from SI Units	21
App.F	Allowable Current of Insulated Wires	23
App.G	Replacement Information	25
G.1	External dimensions comparison tables	25
G.2	Terminal arrangements and symbols	29
G.3	Function codes	31

App.A Advantageous Use of Inverters (Notes on electrical noise)

- Disclaimer: This document provides you with a summary of the Technical Document of the Japan Electrical Manufacturers' Association (JEMA) (April 1994). It is intended to apply to the domestic market only. It is only for reference for the foreign market. -

A.1 Effect of inverters on other devices

Inverters have been and are rapidly expanding its application fields. This paper describes the effect that inverters have on electronic devices already installed or on devices installed in the same system as inverters, as well as introducing noise prevention measures. (Refer to Section A.3 [3], "Noise prevention examples" for details.)

[1] Effect on AM radios

Phenomenon If an inverter operates, AM radios may pick up noise radiated from the inverter. (An inverter has almost no effect on FM radios or television sets.)

Probable cause Radios may receive noise radiated from the inverter.

Measures Inserting a noise filter on the power supply side of the inverter is effective.

[2] Effect on telephones

Phenomenon If an inverter operates, nearby telephones may pick up noise radiated from the inverter in conversation so that it may be difficult to hear.

Probable cause A high-frequency leakage current radiated from the inverter and motors enters shielded telephone cables, causing noise.

Measures It is effective to commonly connect the grounding terminals of the motors and return the common grounding line to the grounding terminal of the inverter.

[3] Effect on proximity limit switches

Phenomenon If an inverter operates, proximity limit switches (capacitance-type) may malfunction.

Probable cause The capacitance-type proximity limit switches may provide inferior noise immunity.

Measures It is effective to connect a filter to the input terminals of the inverter or change the power supply treatment of the proximity limit switches. The proximity limit switches can be replaced with superior noise immunity types such as magnetic types.

[4] Effect on pressure sensors

Phenomenon If an inverter operates, pressure sensors may malfunction.

Probable cause Noise may penetrate through a grounding wire into the signal line.

Measures It is effective to install a noise filter on the power supply side of the inverter or to change the wiring.

[5] Effect on position detectors (pulse generators PGs or pulse encoders)

Phenomenon If an inverter operates, pulse encoders may produce erroneous pulses that shift the stop position of a machine.

Probable cause Erroneous pulses are liable to occur when the signal lines of the PG and power lines are bundled together.

Measure The influence of induction noise and radiation noise can be reduced by separating the PG signal lines and power lines. Providing noise filters at the input and output terminals is also an effective measure.

A.2 Noise

This section gives a summary of noises generated in inverters and their effects on devices subject to noise.

[1] Inverter noise

Figure A.1 shows an outline of the inverter configuration. The inverter converts AC to DC (rectification) in a converter unit, and converts DC to AC (inversion) with 3-phase variable voltage and variable frequency. The conversion (inversion) is performed by PWM implemented by switching six transistors (IGBT: Insulated Gate Bipolar Transistor, etc), and is used for variable speed motor control.

Switching noise is generated by high-speed on/off switching of the six transistors. Noise current (i) is emitted and at each high-speed on/off switching, the noise current flows through stray capacitance (C) of the inverter, cable and motor to the ground. The amount of the noise current is expressed as follows:

$$i = C \cdot dv/dt$$

It is related to the stray capacitance (C) and dv/dt (switching speed of the transistors). Further, this noise current is related to the carrier frequency since the noise current flows each time the transistors are switched on or off.

In addition to the main power inverter, the DC-to-DC switching power regulator (DC-DC converter), which is the power source for the control electronics of the inverter, may be a noise source in the same principles as stated above.

The frequency band of this noise is less than approximately 30 to 40 MHz. Therefore, the noise will affect devices such as AM radios using low frequency band, but will not virtually affect FM radios and television sets using higher frequency than this frequency band.

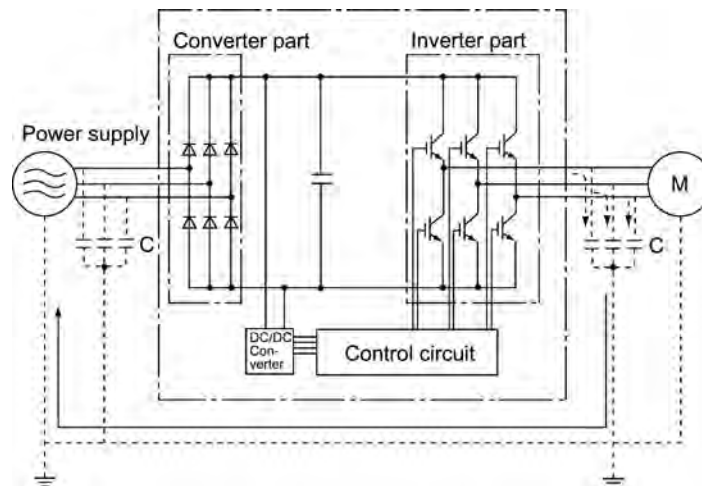

Figure A.1 Outline of Inverter Configuration

[2] Types of noise

Noise generated in an inverter is propagated through the main circuit wiring to the power supply and the motor so as to affect a wide range of applications from the power supply transformer to the motor. The various propagation routes are shown in Figure A.2. According to those routes, noises are roughly classified into three types--conduction noise, induction noise, and radiation noise.

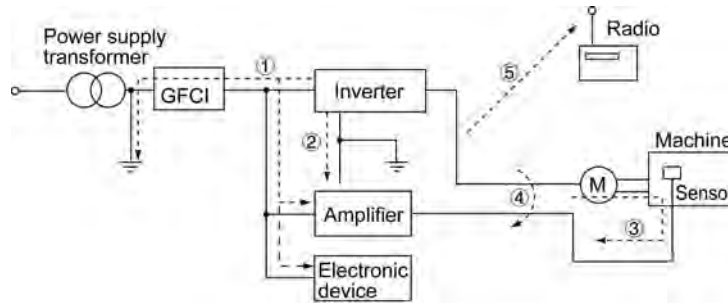

Figure A.2 Noise Propagation Routes

(1) Conduction noise

Noise generated in an inverter may propagate through the conductor and power supply so as to affect peripheral devices of the inverter (Figure A.3). This noise is called "conduction noise." Some conduction noises will propagate through the main circuit ①. If the ground wires are connected to a common ground, conduction noise will propagate through route ②. As shown in route ③, some conduction noises will propagate through signal lines or shielded wires.

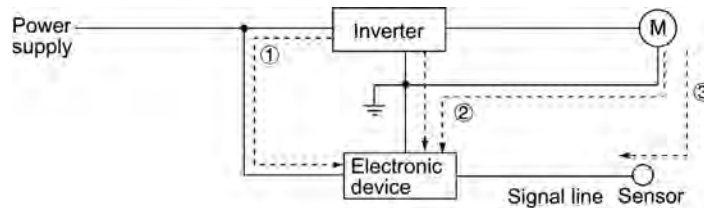

Figure A.3 Conduction Noise

(2) Induction noise

When wires or signal lines of peripheral devices are brought close to the wires on the input and output sides of the inverter through which noise current is flowing, noise will be induced into those wires and signal lines of the devices by electromagnetic induction (Figure A.4) or electrostatic induction (Figure A.5). This is called "induction noise" ④.

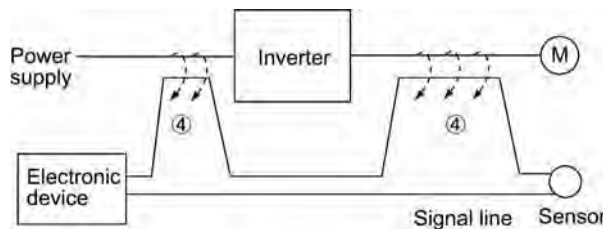

Figure A.4 Electromagnetic Noise

App.

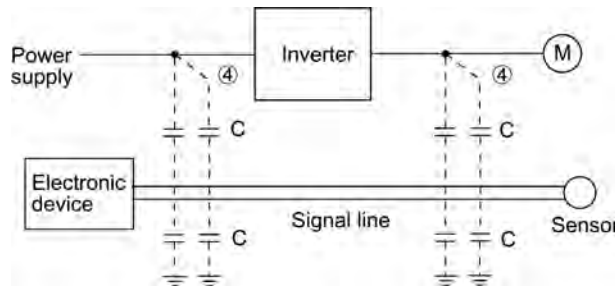

Figure A.5 Electrostatic Noise

(3) Radiation noise

Noise generated in an inverter may be radiated through the air from wires (that act as antennas) at the input and output sides of the inverter. This noise is called "radiation noise" (5) as shown below. Not only wires but motor frames or control system panels containing inverters may also act as antennas.

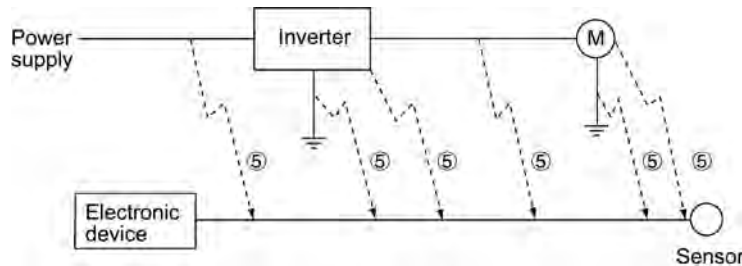

Figure A.6 Radiation Noise

A.3 Noise prevention

The more noise prevention is strengthened, the more effective. However, with the use of appropriate measures, noise problems may be resolved easily. It is necessary to implement economical noise prevention according to the noise level and the equipment conditions.

[1] Noise prevention prior to installation

Before inserting an inverter in your control panel or installing an inverter panel, you need to consider noise prevention. Once noise problems occur, it will cost additional materials and time for solving them.

Noise prevention prior to installation includes:

- 1) Separating the wiring of main circuits and control circuits
- 2) Putting main circuit wiring into a metal pipe (conduit pipe)
- 3) Using shielded wires or twist shielded wires for control circuits.
- 4) Implementing appropriate grounding work and grounding wiring.

These noise prevention measures can avoid most noise problems.

[2] Implementation of noise prevention measures

There are two types of noise prevention measures--one for noise propagation routes and the other for noise receiving sides (that are affected by noise).

The basic measures for lessening the effect of noise at the receiving side include:

Separating the main circuit wiring from the control circuit wiring, avoiding noise effect.

The basic measures for lessening the effect of noise at the generating side include:

- 1) Inserting a noise filter that reduces the noise level.
- 2) Applying a metal conduit pipe or metal control panel that will confine noise, and
- 3) Applying an insulated transformer for the power supply that cuts off the noise propagation route.

Table A.1 lists the noise prevention measures, their goals, and propagation routes.

Table A.1 Noise Prevention Measures

Noise prevention method		Goal of noise prevention measures				Conduction route		
		Make it more difficult to receive noise	Cutoff noise conduction	Confine noise	Reduce noise level	Conduction noise	Induction noise	Radiation noise
Wiring and installation	Separate main circuit from control circuit	Y					Y	
	Minimize wiring distance	Y			Y		Y	Y
	Avoid parallel and bundled wiring	Y					Y	
	Use appropriate grounding	Y			Y	Y	Y	
	Use shielded wire and twisted shielded wire	Y					Y	Y
	Use shielded cable in main circuit			Y			Y	Y
	Use metal conduit pipe			Y			Y	Y
Control panel	Appropriate arrangement of devices in panel	Y					Y	Y
	Metal control panel			Y			Y	Y
Anti-noise device	Line filter	Y			Y	Y		Y
	Insulation transformer		Y			Y		Y
Measures at noise receiving sides	Use a passive capacitor for control circuit	Y					Y	Y
	Use ferrite core for control circuit	Y			Y		Y	Y
	Line filter	Y		Y		Y		
Others	Separate power supply systems		Y			Y		
	Lower the carrier frequency				Y*	Y	Y	Y

Y: Effective, Y*: Effective conditionally, Blank: Not effective

App.

What follows is noise prevention measures for the inverter drive configuration.

(1) Wiring and grounding

As shown in Figure A.7, separate the main circuit wiring from control circuit wiring as far as possible regardless of being located inside or outside the system control panel containing an inverter. Use shielded wires and twisted shielded wires that will block out extraneous noises, and minimize the wiring distance. Also avoid bundled wiring of the main circuit and control circuit or parallel wiring.

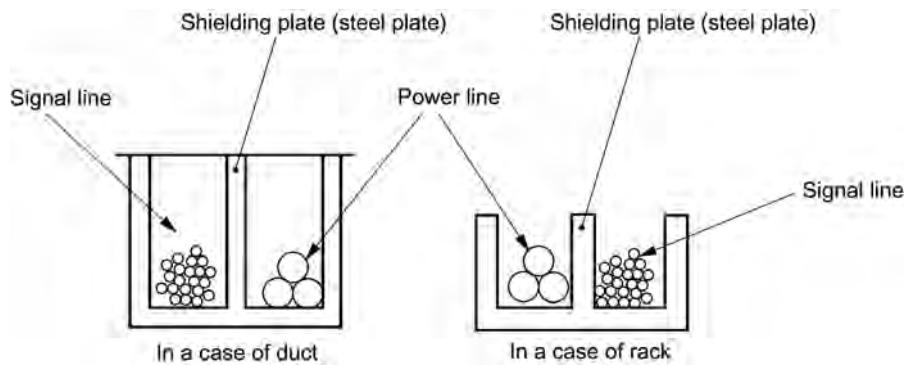

Figure A.7 Separate Wiring

For the main circuit wiring, use a metal conduit pipe and connect its wires to the ground to prevent noise propagation (refer to Figure A.8).

The shield (braided wire) of a shielded wire should be securely connected to the base (common) side of the signal line at only one point to avoid the loop formation resulting from a multi-point connection (refer to Figure A.9).

The grounding is effective not only to reduce the risk of electrical shocks due to leakage current, but also to block noise penetration and radiation. Corresponding to the main circuit voltage, the grounding work should be No. 3 grounding work (300 VAC or less) and special No. 3 grounding work (300 to 600 VAC). Each ground wire is to be provided with its own ground or separately wired to a grounding point.

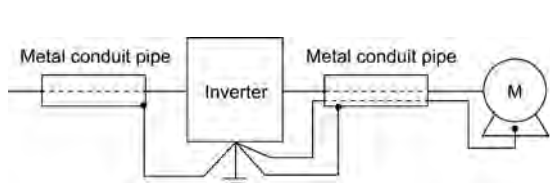

Figure A.8 Grounding of Metal Conduit Pipe

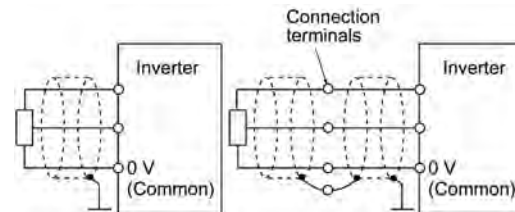

Figure A.9 Treatment of Braided Wire of Shielded Wire

(2) Control panel

The system control panel containing an inverter is generally made of metal, which can shield noise radiated from the inverter itself.

When installing other electronic devices such as a programmable logic controller in the same control panel, be careful with the layout of each device. If necessary, arrange shield plates between the inverter and peripheral devices.

(3) Anti-noise devices

To reduce the noise propagated through the electrical circuits and the noise radiated from the main circuit wiring to the air, a line filter and power supply transformer should be used (refer to Figure A.10).

Line filters are available in these types--the simplified type such as a capacitive filter to be connected in parallel to the power supply line and an inductive filter to be connected in series to the power supply line and the orthodox type such as an LC filter to meet radio noise regulations. Use them according to the targeted effect for reducing noise.

Power supply transformers include common insulated transformers, shielded transformers, and noise-cutting transformers. These transformers have different effectiveness in blocking noise propagation.

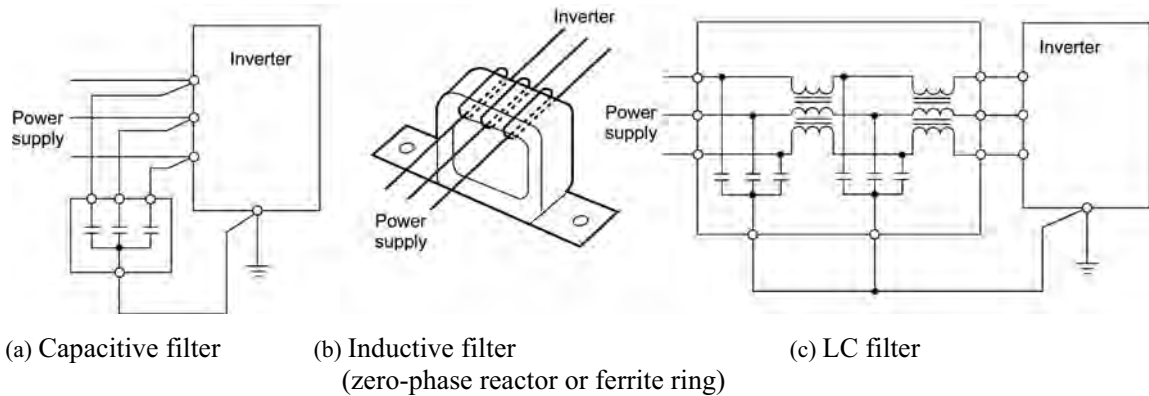

Figure A.10 Various Filters and their Connection

(4) Noise prevention measures at the receiving side

It is important to strengthen the noise immunity of those electronic devices installed in the same control panel as the inverter or located near an inverter. Line filters and shielded or twisted shielded wires are used to block the penetration of noise in the signal lines of these devices. The following treatments are also implemented.

- 1) Lower the circuit impedance by connecting capacitors or resistors to the input and output terminals of the signal circuit in parallel.
- 2) Increase the circuit impedance for noise by inserting choke coils in series in the signal circuit or passing signal lines through ferrite core beads. It is also effective to widen the signal base lines (0 V line) or grounding lines.

(5) Other

The level of generating/propagating noise will change with the carrier frequency of the inverter. The higher the carrier frequency, the higher the noise level.

In an inverter whose carrier frequency can be changed, lowering the carrier frequency can reduce the generation of electrical noise and result in a good balance with the audible noise of the motor under driving conditions.

App.

[3] Noise prevention examples

Table A.2 lists examples of the measures to prevent noise generated by a running inverter.

Table A.2 Examples of Noise Prevention Measures

No.	Target device	Phenomena	Noise prevention measures	
				Notes
1	AM radio	<p>When operating an inverter, noise enters into an AM radio broadcast (500 to 1500 kHz).</p>  <p><Possible cause> The AM radio may receive noise radiated from wires at the power supply and output sides of the inverter.</p>	<ol style="list-style-type: none"> 1) Install an LC filter at the power supply side of the inverter. (In some cases, a capacitive filter may be used as a simple method.) 2) Install a metal conduit wiring between the motor and inverter. Or use shielded wiring.  <p>Note: Minimize the distance between the LC filter and inverter as much as possible (within 3.3ft (1m)).</p>	<ol style="list-style-type: none"> 1) The radiation noise of the wiring can be reduced. 2) The conduction noise to the power supply side can be reduced. <p>Note: Sufficient improvement may not be expected in narrow regions such as between mountains.</p>
2	AM radio	<p>When operating an inverter, noise enters into an AM radio broadcast (500 to 1500 kHz).</p>  <p><Possible cause> The AM radio may receive noise radiated from the power line at the power supply side of the inverter.</p>	<ol style="list-style-type: none"> 1) Install inductive filters at the input and output sides of the inverter.  <p>The number of turns of the zero-phase reactor (or ferrite ring) should be as large as possible. In addition, wiring between the inverter and the zero-phase reactor (or ferrite ring) should be as short as possible. (within 3.3ft (1m))</p> <ol style="list-style-type: none"> 2) When further improvement is necessary, install LC filters. 	<ol style="list-style-type: none"> 1) The radiation noise of the wiring can be reduced.

Table A.2 Continued

No.	Target device	Phenomena	Noise prevention measures	Notes
3	Telephone (in a common private residence at a distance of 131 ft (40 m))	<p>When driving a ventilation fan with an inverter, noise enters a telephone in a private residence at a distance of 131 ft (40m).</p>  <p><Possible cause> A high-frequency leakage current from the inverter and motor flowed to grounded part of the telephone cable shield. During the current's return trip, it flowed through a grounded pole transformer, and noise entered the telephone by electrostatic induction.</p>	<p>1) Connect the ground terminals of the motors in a common connection. Return to the inverter panel, and insert a 1 μF capacitor between the input terminal of the inverter and ground.</p> 	<p>1) The effect of the inductive filter and LC filter may not be expected because of sound frequency component.</p> <p>2) In the case of a V-connection power supply transformer in a 230V system, it is necessary to connect capacitors as shown in the following figure, because of different potentials to ground.</p>
4	Photoelectric relay	<p>A photoelectric relay malfunctioned when the inverter runs the motor. [The inverter and motor are installed in the same place (for overhead traveling)]</p>  <p><Possible cause> It is considered that induction noise entered the photoelectric relay since the inverter's input power supply line and the photoelectric relay's wiring are in parallel separated by approximately 0.98 in (25 mm) over a distance of 98 to 131 ft (30 to 40 m). Due to conditions of the installation, these lines cannot be separated.</p>	<p>1) As a temporary measure, Insert a 0.1 μF capacitor between the 0 V terminal of the power supply circuit in the detection unit of the overhead photoelectric relay and a frame of the overhead panel.</p>  <p>2) As a permanent measure, move the 24 V power supply from the ground to the overhead unit so that signals are sent to the ground side with relay contacts in the ceiling part.</p>	<p>1) The wiring is separated by more than 11.81 in (30 cm).</p> <p>2) When separation is impossible, signals can be received and sent with dry contacts etc.</p> <p>3) Do not wire weak-current signal lines and power lines in parallel.</p>

Table A.2 Continued

No.	Target device	Phenomena	Noise prevention measures	Notes
5	Photoelectric relay	<p>A photoelectric relay malfunctioned when the inverter was operated.</p>  <p><Possible cause> Although the inverter and photoelectric relay are separated by a sufficient distance but the power supplies share a common connection, it is considered that conduction noise entered through the power supply line into the photoelectric relay.</p>	<p>1) Insert a 0.1 μF capacitor between the output common terminal of the amplifier of the photoelectric relay and the frame.</p> 	<p>1) If a weak-current circuit at the malfunctioning side is observed, the measures may be simple and economical.</p>
6	Proximity limit switch (electrostatic type)	<p>A proximity limit switch malfunctioned.</p>  <p><Possible cause> It is considered that the capacitance type proximity limit switch is susceptible to conduction and radiation noise because of its low noise immunity.</p>	<p>1) Install an LC filter at the output side of the inverter. 2) Install a capacitive filter at the input side of the inverter. 3) Ground the 0 V (common) line of the DC power supply of the proximity limit switch through a capacitor to the box body of the machine.</p> 	<p>1) Noise generated in the inverter can be reduced. 2) The switch is superseded by a proximity limit switch of superior noise immunity (such as a magnetic type).</p>

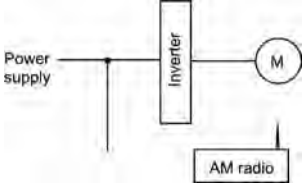
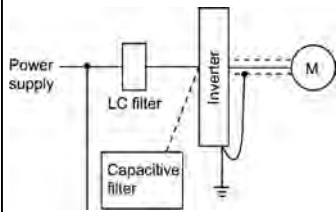
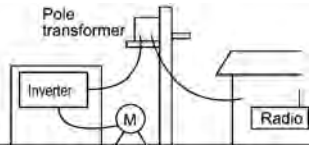
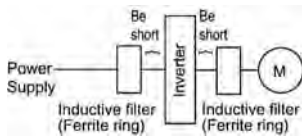
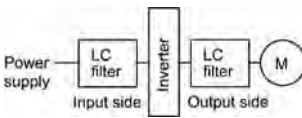
Table A.2 Continued

No.	Target device	Phenomena	Noise prevention measures	Notes
7	Pressure sensor	<p>A pressure sensor malfunctioned.</p>  <p><Possible cause> The pressure sensor may malfunction due to noise that came from the box housing through the shielded wire.</p>	<ol style="list-style-type: none"> 1) Install an LC filter on the input side of the inverter. 2) Connect the shield of the shielded wire of the pressure sensor to the 0 V line (common) of the pressure sensor, changing the original connection. 	<ol style="list-style-type: none"> 1) The shielded parts of shield wires for sensor signals are connected to a common point in the system. 2) Conduction noise from the inverter can be reduced.
8	Position detector (pulse generator : PG)	<p>Erroneous-pulse outputs from a pulse converter caused a shift in the stop position of a crane.</p>  <p><Possible cause> Erroneous pulses may be outputted by induction noise since the power line of the motor and the signal line of the PG are bundled together.</p>	<ol style="list-style-type: none"> 1) Install an LC filter and a capacitive filter at the input side of the inverter. 2) Install an LC filter at the output side of the inverter. 	<ol style="list-style-type: none"> 1) This is an example of a measure where the power line and signal line cannot be separated. 2) Induction noise and radiation noise at the output side of the inverter can be reduced.
9	Program mable logic controller (PLC)	<p>The PLC program sometimes malfunctions.</p>  <p><Possible cause> Since the power supply system is the same for the PLC and inverter, it is considered that noise enters the PLC through the power supply.</p>	<ol style="list-style-type: none"> 1) Install a capacitive filter and an LC filter on the input side of the inverter. 2) Install an LC filter on the output side of the inverter. 3) Lower the carrier frequency of the inverter. 	<ol style="list-style-type: none"> 1) Total conduction noise and induction noise in the electric line can be reduced.

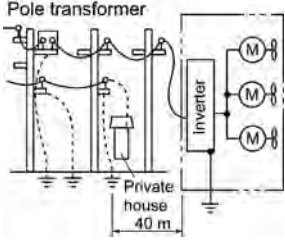
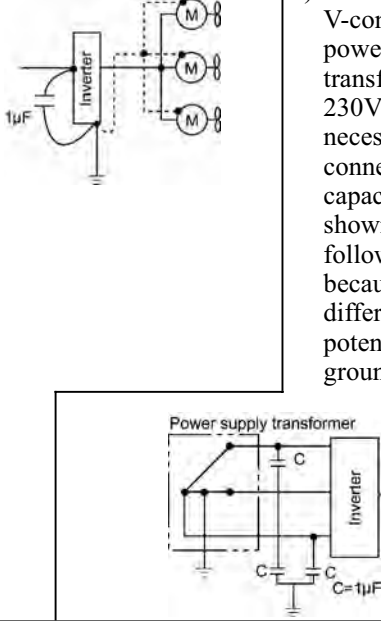
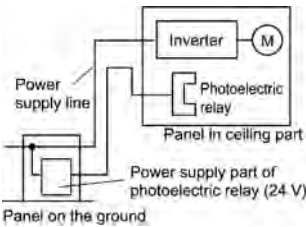
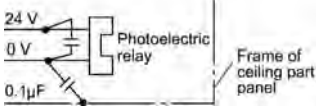
App.

App.B Japanese Guideline for Suppressing Harmonics by Customers Receiving High Voltage or Special High Voltage

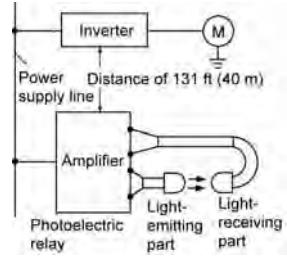
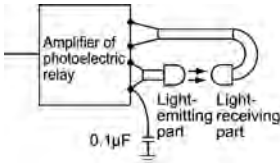
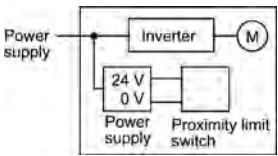
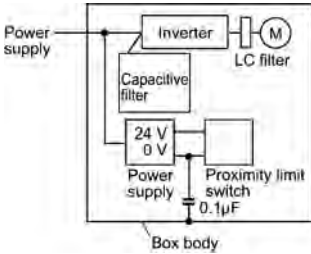
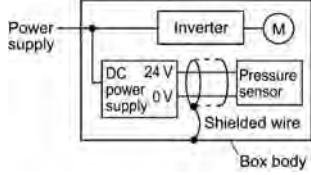
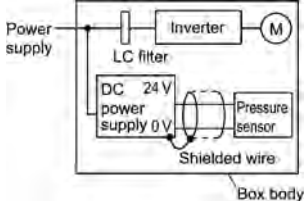
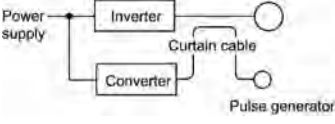
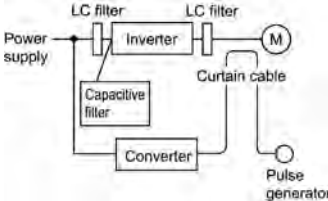
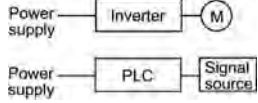
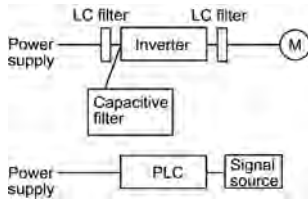
- Disclaimer: This document provides you with a translated summary of the Guideline of the Ministry of International Trade and Industry (September 1994). It is intended to apply to the domestic market only. It is only for reference for the foreign market. -

Agency of Natural Resource and Energy of Japan published the following two guidelines for suppressing harmonic noise in September 1994.

- (1) Guideline for suppressing harmonics in home electric and general-purpose appliances
- (2) Guideline for suppressing harmonics by customers receiving high voltage or special high voltage

Assuming that electronic devices generating high harmonics will be increasing, these guidelines are to establish regulations for preventing high frequency noise interference on devices sharing the power source. These guidelines should be applied to all devices that are used on the commercial power lines and generate harmonic current. This section gives a description limited to general-purpose inverters.

B.1 Application to general-purpose inverters

[1] Guideline for suppressing harmonics in home electric and general-purpose appliances

Our three-phase, 230V inverters of 5 HP or less (FRENIC-Mini series) were the products of which were restricted by the "Guideline for Suppressing Harmonics in Home Electric and General-purpose Appliances" (established in September 1994 and revised in October 1999) issued by the Ministry of Economy, Trade and Industry.

The above restriction, however, was lifted when the Guideline was revised in January 2004. Since then, the inverter makers have individually imposed voluntary restrictions on the harmonics of their products.

We, as before, recommend that you connect a reactor (for suppressing harmonics) to your inverter.

[2] Guideline for suppressing harmonics by customers receiving high voltage or special high voltage

Unlike other guidelines, this guideline is not applied to the equipment itself such as a general-purpose inverter, but is applied to each large-scale electric power consumer for total amount of harmonics. The consumer should calculate the harmonics generated from each piece of equipment currently used on the power source transformed and fed from the high or special high voltage source.

(1) Scope of regulation

In principle, the guideline applies to the customers that meet the following two conditions:

- The customer receives high voltage or special high voltage.
- The "equivalent capacity" of the converter load exceeds the standard value for the receiving voltage (50 kVA at a receiving voltage of 6.6 kV).

Appendix B.2 [1] "Calculation of equivalent capacity (Pi)" gives you some supplemental information with regard to estimation for the equivalent capacity of an inverter according to the guideline.

(2) Regulation

The level (calculated value) of the harmonic current that flows from the customer's receiving point out to the system is subjected to the regulation. The regulation value is proportional to the contract demand. The regulation values specified in the guideline are shown in Table B.1.

Appendix B.2 gives you some supplemental information with regard to estimation for the equivalent capacity of the inverter for compliance to "Japanese guideline for suppressing harmonics by customers receiving high voltage or special high voltage."

Table B.1 Upper Limits of Harmonic Outflow Current per kW of Contract Demand (mA/HP)

Receiving voltage	5th	7th	11th	13th	17th	19th	23rd	Over 25th
6.6 kV	3.5	2.5	1.6	1.3	1.0	0.90	0.76	0.70
22 kV	1.8	1.3	0.82	0.69	0.53	0.47	0.39	0.36

(3) When the regulation applied

The guideline has been applied. As the application, the estimation for "Voltage waveform distortion rate" required as the indispensable conditions when entering into the consumer's contract of electric power is already expired.

B.2 Compliance to the harmonic suppression for customers receiving high voltage or special high voltage

When calculating the required matters related to inverters according to the guideline, follow the terms listed below. The following descriptions are based on "Technical document for suppressing harmonics" (JEGE 9702-1995) published by the Japan Electrical Manufacturer's Association (JEMA).

[1] Calculation of equivalent capacity (Pi)

The equivalent capacity (Pi) may be calculated using the equation of (input rated capacity) x (conversion factor). However, catalogs of conventional inverters do not contain input rated capacities, so a description of the input rated capacity is shown below:

(1) "Inverter rated capacity" corresponding to "Pi"

- In the guideline, the conversion factor of a 6-pulse converter is used as reference conversion factor 1. It is, therefore, necessary to express the rated input capacity of inverters in a value including harmonic component current equivalent to conversion factor 1.
- Calculate the input fundamental current I₁ from the kW rating and efficiency of the load motor, as well as the efficiency of the inverter. Then, calculate the input rated capacity as shown below:

$$\text{Input rated capacity} = \sqrt{3} \times (\text{power supply voltage}) \times I_1 \times 1.0228/1000 \text{ (kVA)}$$

where 1.0228 is the 6-pulse converter's value of (effective current)/(fundamental current).

- When a general-purpose motor or inverter motor is used, the appropriate value shown in Table B.2 can be used. Select a value based on the kW rating of the motor used, irrespective of the inverter type.



The input rated capacity shown above is for the dedicated use in the equation to calculate capacity of the inverters, following the guideline. Note that the capacity can not be applied to the reference for selection of the equipment or wires to be used in the inverter input circuits.



For selection of capacity for the peripheral equipment, refer to the catalogs or technical documents issued from their manufacturers.

Table B.2 "Input Rated Capacities" of General-purpose Inverters Determined by the Applicable Motor Ratings

Applicable motor rating (HP)		1/2	1	2	3	5	7.5
Pi (kVA)	230V	0.57	0.97	1.95	2.81	4.61	6.77
	460V	0.57	0.97	1.95	2.81	4.61	6.77

(2) Values of "Ki (conversion factor)"

Depending on whether an optional ACR (AC reactor) or DCR (DC reactor) is used, apply the appropriate conversion factor specified in the appendix to the guideline. The values of the conversion factor are listed in Table B.3.

Table B.3 "Conversion Factors Ki" for General-purpose Inverters Determined by Reactors

Circuit category	Circuit type		Conversion factor Ki	Main applications
3	3-phase bridge (capacitor smoothing)	w/o reactor	K31=3.4	<ul style="list-style-type: none"> • General-purpose inverters • Elevators • Refrigerators, air conditioning systems • Other general appliances
		w/- reactor (ACR)	K32=1.8	
		w/- reactor (DCR)	K33=1.8	
		w/- reactors (ACR and DCR)	K34=1.4	

Note Some models are equipped with a reactor as a built-in standard accessory.

(3) Exception to this guideline

Inverters whose inputs are 115V or 230V lines and capacities are 5 HP or less are an exception to this guideline.

Those excluded inverters are already regulated by the "Japanese guideline for suppressing harmonics in home electric and general-purpose appliances" so that all of them are not regulated by this guideline regardless of the quantity of the units used by a single customer.

[2] Calculation of Harmonic Current

(1) Value of "input fundamental current"

- When you calculate the amount of harmonics according to Table 2 in Appendix of the Guideline, you have to previously know the input fundamental current.
- Apply the appropriate value shown in Table B.4 based on the kW rating of the motor, irrespective of the inverter type or whether a reactor is used.

Note If the input voltage is different, calculate the input fundamental current in inverse proportion to the voltage.

Table B.4 "Input Fundamental Currents" of General-purpose Inverters Determined by the Applicable Motor Ratings

Applicable motor rating (HP)		1/2	1	2	3	5	7.5
Input fundamental current (A)	230V	1.62	2.74	5.50	7.92	13.0	19.1
	460V	0.81	1.37	2.75	3.96	6.50	9.55
6.6 kV converted value (mA)		49	83	167	240	394	579

(2) Calculation of harmonic current

Usually, calculate the harmonic current according to the Sub-table 3 "Three phase bridge rectifier with the filtering capacitor" in Table 2 of the Guideline's Appendix. Table B.5 lists the contents of the Sub-table 3.

Table B.5 Generated Harmonic Current (%), 3-phase Bridge Rectifier (Capacitor Filtering)

Degree	5th	7th	11th	13th	17th	19th	23rd	25th
w/o a reactor	65	41	8.5	7.7	4.3	3.1	2.6	1.8
w/- a reactor (ACR)	38	14.5	7.4	3.4	3.2	1.9	1.7	1.3
w/- a reactor (DCR)	30	13	8.4	5.0	4.7	3.2	3.0	2.2
w/- reactors (ACR and DCR)	28	9.1	7.2	4.1	3.2	2.4	1.6	1.4

- ACR: 3%
- DCR: Accumulated energy equal to 0.08 to 0.15 ms (100% load conversion)
- Smoothing capacitor: Accumulated energy equal to 15 to 30 ms (100% load conversion)
- Load: 100%

Calculate the harmonic current of each degree using the following equation:

$$\text{nth harmonic current (A)} = \text{Fundamental current (A)} \times \frac{\text{Generated nth harmonic current (\%)}}{100}$$

(3) Maximum availability factor

- For a load for elevators, which provides intermittent operation, or a load with a sufficient designed motor rating, reduce the current by multiplying the equation by the "maximum availability factor" of the load.
- The "maximum availability factor of an appliance" means the ratio of the capacity of the harmonic generator in operation at which the availability reaches the maximum, to its total capacity, and the capacity of the generator in operation is an average for 30 minutes.
- In general, the maximum availability factor is calculated according to this definition, but the standard values shown in Table B.6 are recommended for inverters for building equipment.

Table B.6 Availability Factors of Inverters, etc. for Building Equipment (Standard Values)

Equipment type	Inverter capacity category	Single inverter availability
Air conditioning system	300 HP or less	0.55
	Over 300 HP	0.60
Sanitary pump	————	0.30
Elevator	————	0.25
Refrigerator, freezer	50 kW or less	0.60
UPS (6-pulse)	200 kVA	0.60

Correction coefficient according to contract demand level

Since the total availability factor decreases if the scale of a building increases, calculating reduced harmonics with the correction coefficient β defined in Table B.7 is permitted.

Table B.7 Correction Coefficient according to the Building Scale

Contract demand (HP)	Correction coefficient β
300	1.00
800	0.90
1000	0.85
2000	0.80

Note: If the contract demand is between two specified values listed in Table B.7, calculate the value by interpolation.

Note: The correction coefficient β is to be determined as a matter of consultation between the customer and electric power supplier for the customers receiving the electric power over 2000 kW or from the special high voltage lines.

(4) Degree of harmonics to be calculated

The higher the degree of harmonics, the lower the current flows. This is the property of harmonics generated by inverters so that the inverters are covered by "The case not causing a special hazard" of the term (3) in the above Appendix for the 9th or higher degrees of the harmonics.

Therefore, "It is sufficient that the 5th and 7th harmonic currents should be calculated."

[3] Examples of calculation

(1) Equivalent capacity

Example of loads	Input capacity and No. of inverters	Conversion factor	Equivalent capacity
[Example 1] 400V, 5 HP, 10 units w/- AC reactor and DC reactor	4.61 kVA × 10 units	K32 = 1.4	4.61 × 10 × 1.4 = 64.54 kVA
[Example 2] 400V, 2 HP, 15 units w/- AC reactor	2.93 kVA × 15 units	K34 = 1.8	2.93 × 15 × 1.8 = 79.11 kVA
	Refer to Table B.2.	Refer to Table B.3.	

(2) Harmonic current every degrees

[Example 1] 400V, 5 HP 10 units, w/- AC reactor, and maximum availability: 0.55

Fundamental current onto 6.6 kV lines (mA)	Harmonic current onto 6.6 kV lines (mA)							
394 × 10 = 3940 3940 × 0.55 = 2167	5th (38%)	7th (14.5%)	11th (7.4%)	13th (3.4%)	17th (3.2%)	19th (1.9%)	23rd (1.7%)	25th (1.3%)
	823.5	314.2						
Refer to Tables B.4 and B.6.	Refer to Table B.5.							

[Example 2] 400V, 5 HP, 15 units, w/- AC reactor and DC reactor, and maximum availability: 0.55

Fundamental current onto 6.6 kV lines (mA)	Harmonic current onto 6.6 kV lines (mA)							
394 × 15 = 5910 5910 × 0.55 = 3250.5	5th (28%)	7th (9.1%)	11th (7.2%)	13th (4.1%)	17th (3.2%)	19th (2.4%)	23rd (1.6%)	25th (1.4%)
	910.1	295.8						
Refer to Tables B.4 and B.6.	Refer to Table B.5.							

App.C Effect on Insulation of General-purpose Motors Driven with 460 V Class Inverters

- Disclaimer: This document provides you with a summary of the Technical Document of the Japan Electrical Manufacturers' Association (JEMA) (March, 1995). It is intended to apply to the domestic market only. It is only for reference for the foreign market. -

Preface

When an inverter drives a motor, surge voltages generated by switching the inverter elements are superimposed on the inverter output voltage and applied to the motor terminals. If the surge voltages are too high they may have an effect on the motor insulation and some cases have resulted in damage.

For preventing such cases this document describes the generating mechanism of the surge voltages and countermeasures against them.

 Refer to A.2 [1] "Inverter noise" for details of the principle of inverter operation.

C.1 Generating mechanism of surge voltages

As the inverter rectifies a commercial power source voltage and smoothes into a DC voltage, the magnitude E of the DC voltage becomes about $\sqrt{2}$ times that of the source voltage (about 620V in case of an input voltage of 440 VAC). The peak value of the output voltage is usually close to this DC voltage value.

But, as there exists inductance (L) and stray capacitance (C) in wiring between the inverter and the motor, the voltage variation due to switching the inverter elements causes a surge voltage originating in LC resonance and results in the addition of high voltage to the motor terminals. (Refer to Figure C.1)

This voltage sometimes reaches up to about twice that of the inverter DC voltage ($620V \times 2 =$ approximately 1,200V) depending on a switching speed of the inverter elements and wiring conditions.

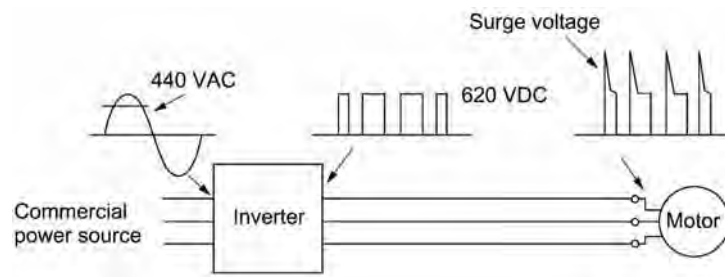
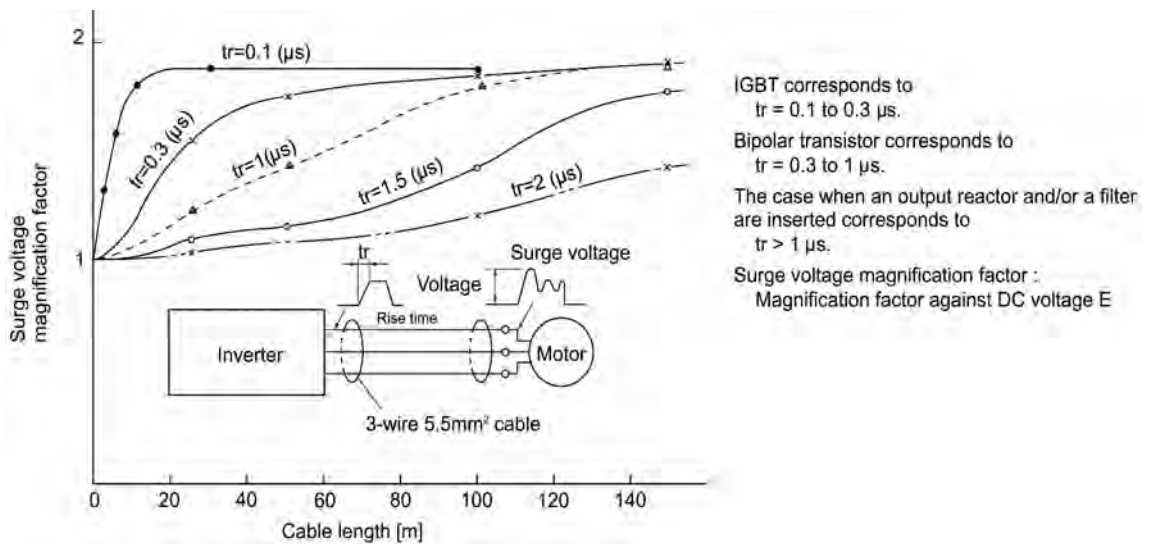

Figure C.1 Voltage Wave Shapes of Individual Portions

A measured example in Figure C.2 illustrates the relation of a peak value of the motor terminal voltage with a wiring length between the inverter and the motor.

From this it can be confirmed that the peak value of the motor terminal voltage ascends as the wiring length increases and becomes saturated at about twice the inverter DC voltage.

The shorter a pulse rise time becomes, the higher the motor terminal voltage rises even in the case of a short wiring length.



Excerpt from [J. IEE Japan, Vol. 107, No. 7, 1987]

Figure C.2 Measured Example of Wiring Length and Peak Value of Motor Terminal Voltage

C.2 Effect of surge voltages

The surge voltages originating in LC resonance of wiring may be applied to the motor input terminals and depending on their magnitude sometimes cause damage to the motor insulation.

When the motor is driven with a 230 V class inverter, the dielectric strength of the insulation is no problem since the peak value at the motor terminal voltage increases twice due to the surge voltages (the DC voltage is only about 300 V).

But in case of a 400 V class inverter the DC voltage is approximately 600 V and depending on the wiring length, the surge voltages may greatly increase and sometimes result in damage to the insulation.

C.3 Countermeasures against surge voltages

The following methods are countermeasures against damage to the motor insulation by the surge voltages and using a motor driven with a 400 V class inverter.

[1] Method using motors with enhanced insulation

Enhanced insulation of a motor winding allows its surge proof strength to be improved.

[2] Method to suppress surge voltages

There are two methods for suppressing the surge voltages, one is to reduce the voltage rise time and another is to reduce the voltage peak value.

(1) Output reactor

If wiring length is relatively short the surge voltages can be suppressed by reducing the voltage rise time (dv/dt) with the installation of an AC reactor on the output side of the inverter. (Refer to Figure C.3 (1).)

However, if the wiring length becomes long, suppressing the peak voltage due to surge voltage may be difficult.

(2) Output filter

Installing a filter on the output side of the inverter allows a peak value of the motor terminal voltage to be reduced. (Refer to Figure C.3 (2).)

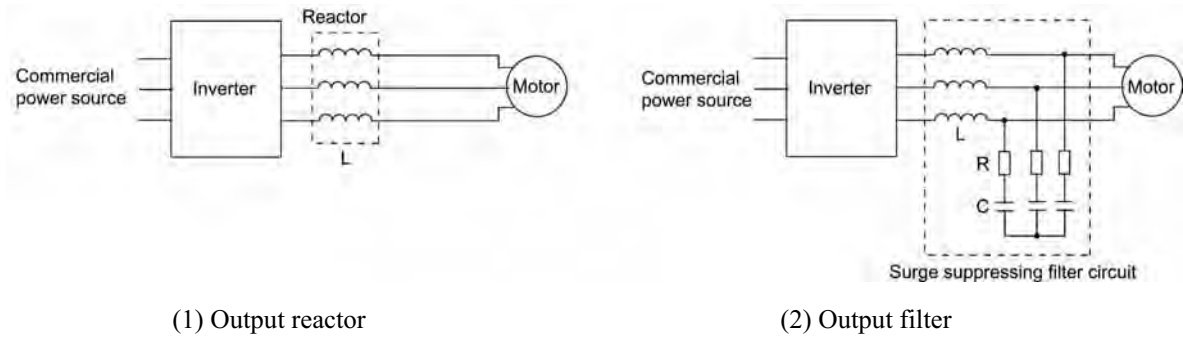

Figure C.3 Method to Suppress Surge Voltage

C.4 Regarding existing equipment

[1] In case of a motor being driven with 460 V class inverter

A survey over the last five years on motor insulation damage due to the surge voltages originating from switching of inverter elements shows that the damage incidence is 0.013% under the surge voltage condition of over 1,100 V and most of the damage occurs several months after commissioning the inverter. Therefore there seems to be little probability of occurrence of motor insulation damage after a lapse of several months of commissioning.

[2] In case of an existing motor driven using a newly installed 460 V class inverter

We recommend suppressing the surge voltages with the method of Section C.3.

App.D Inverter Generating Loss

The table below lists the inverter generating loss.

Power supply voltage	Applicable motor rating (HP)	Inverter type	Generating loss (W)	
			Low carrier frequency (2 kHz)	High carrier frequency (15 kHz)
Three-phase 230 V	1/8	FRNF12C1■-2U	20	23
	1/4	FRNF25C1■-2U	27	32
	1/2	FRNF50C1■-2U	40	50
	1	FRN001C1■-2U	60	77
	2	FRN002C1■-2U	91	110
	3	FRN003C1■-2U	128	165
	5	FRN005C1■-2U	203	260
Three-phase 460 V	1/2	FRNF50C1■-4U	28	45
	1	FRN001C1■-4U	41	64
	2	FRN002C1■-4U	63	103
	3	FRN003C1■-4U	89	149
	5	FRN005C1■-4U	135	235
Single-phase 230 V	1/8	FRNF12C1■-7U	21	24
	1/4	FRNF25C1■-7U	29	34
	1/2	FRNF50C1■-7U	41	51
	1	FRN001C1■-7U	64	80
	2	FRN002C1■-7U	101	129
	3	FRN003C1■-7U	143	180

Notes 1) A box (■) in the above table replaces S or E depending on enclosure.

App.E Conversion from SI Units

All expressions given in Chapter 7, "SELECTING OPTIMAL MOTOR AND INVERTER CAPACITIES" are based on SI units (International Metric System of Units). This section explains how to convert expressions to other units.

[1] Conversion of units

(1) Force

- 1 (kgf) \approx 9.8 (N)
- 1 (N) \approx 0.102 (kgf)

(2) Torque

- 1 (kgf·m) \approx 9.8 (N·m)
- 1 (N·m) \approx 0.102 (kgf·m)

(3) Work and Energy

- 1 (kgf·m) \approx 9.8 (N·m) = 9.8(J) = 9.8 (W·s)

(4) Power

- 1 (kgf·m/s) \approx 9.8 (N·m/s) = 9.8 (J/s) = 9.8(W)
- 1 (N·m/s) \approx 1 (J/s) = 1 (W) \approx 0.102 (kgf·m/s)

(5) Rotation speed

- 1 (r/min) = $\frac{2\pi}{60}$ (rad/s) \approx 0.1047 (rad/s)
- 1 (rad/s) = $\frac{60}{2\pi}$ (r/min) \approx 9.549 (r/min)

(6) Inertia constant

- J (kg·m²) :moment of inertia
- GD² (kg·m²) :flywheel effect

- $GD^2 = 4 J$

- $J = \frac{GD^2}{4}$

(7) Pressure and stress

- 1 (mmAq) \approx 9.8 (Pa) \approx 9.8 (N/m²)
- 1(Pa) \approx 1(N/m²) \approx 0.102 (mmAq)
- 1 (bar) \approx 100000 (Pa) \approx 1.02 (kg·cm²)
- 1 (kg·cm²) \approx 98000 (Pa) \approx 980 (mbar)
- 1 atmospheric pressure = 1013 (mbar) = 760 (mmHg) = 101300 (Pa) \approx 1.033 (kg/cm²)

[2] Calculation formula

(1) Torque, power, and rotation speed

- $P \text{ (W)} \approx \frac{2\pi}{60} \cdot N \text{ (r/min)} \cdot \tau \text{ (N} \cdot \text{m)}$
- $P \text{ (W)} \approx 1.026 \cdot N \text{ (r/min)} \cdot T \text{ (kgf} \cdot \text{m)}$
- $\tau \text{ (N} \cdot \text{m)} \approx 9.55 \cdot \frac{P \text{ (W)}}{N \text{ (r/min)}}$
- $T \text{ (kgf} \cdot \text{m)} \approx 0.974 \cdot \frac{P \text{ (W)}}{N \text{ (r/min)}}$

(2) Kinetic energy

- $E \text{ (J)} \approx \frac{1}{182.4} \cdot J \text{ (kg} \cdot \text{m}^2) \cdot N^2 \text{ [(r/min)}^2]$
- $E \text{ (J)} \approx \frac{1}{730} \cdot GD^2 \text{ (kg} \cdot \text{m}^2) \cdot N^2 \text{ [(r/min)}^2]$

(3) Torque of linear moving load

Driving mode

- $\tau \text{ (N} \cdot \text{m)} \approx 0.159 \cdot \frac{V \text{ (m/min)}}{N_M \text{ (r/min)} \cdot \eta_G} \cdot F \text{ (N)}$
- $T \text{ (kgf} \cdot \text{m)} \approx 0.159 \cdot \frac{V \text{ (m/min)}}{N_M \text{ (r/min)} \cdot \eta_G} \cdot F \text{ (kgf)}$

Braking mode

- $\tau \text{ (N} \cdot \text{m)} \approx 0.159 \cdot \frac{V \text{ (m/min)}}{N_M \text{ (r/min)} / \eta_G} \cdot F \text{ (N)}$
- $T \text{ (kgf} \cdot \text{m)} \approx 0.159 \cdot \frac{V \text{ (m/min)}}{N_M \text{ (r/min)} / \eta_G} \cdot F \text{ (kgf)}$

(4) Acceleration torque

Driving mode

- $\tau \text{ (N} \cdot \text{m)} \approx \frac{J \text{ (kg} \cdot \text{m}^2)}{9.55} \cdot \frac{\Delta N \text{ (r/min)}}{\Delta t \text{ (s)} \cdot \eta_G}$
- $T \text{ (kgf} \cdot \text{m)} \approx \frac{GD^2 \text{ (kg} \cdot \text{m}^2)}{375} \cdot \frac{\Delta N \text{ (r/min)}}{\Delta t \text{ (s)} \cdot \eta_G}$

Braking mode

- $\tau \text{ (N} \cdot \text{m)} \approx \frac{J \text{ (kg} \cdot \text{m}^2)}{9.55} \cdot \frac{\Delta N \text{ (r/min)} \cdot \eta_G}{\Delta t \text{ (s)}}$
- $T \text{ (kgf} \cdot \text{m)} \approx \frac{GD^2 \text{ (kg} \cdot \text{m}^2)}{375} \cdot \frac{\Delta N \text{ (r/min)} \cdot \eta_G}{\Delta t \text{ (s)}}$

(5) Acceleration time

- $t_{\text{ACC}} \text{ (s)} \approx \frac{J_1 + J_2 / \eta_G \text{ (kg} \cdot \text{m}^2)}{\tau_M - \tau_L / \eta_G \text{ (N} \cdot \text{m)}} \cdot \frac{\Delta N \text{ (r/min)}}{9.55}$
- $t_{\text{ACC}} \text{ (s)} \approx \frac{GD_1^2 + GD_2^2 / \eta_G \text{ (kg} \cdot \text{m}^2)}{T_M - T_L / \eta_G \text{ (kgf} \cdot \text{m)}} \cdot \frac{\Delta N \text{ (r/min)}}{375}$

(6) Deceleration time

- $t_{\text{DEC}} \text{ (s)} \approx \frac{J_1 + J_2 \cdot \eta_G \text{ (kg} \cdot \text{m}^2)}{\tau_M - \tau_L \cdot \eta_G \text{ (N} \cdot \text{m)}} \cdot \frac{\Delta N \text{ (r/min)}}{9.55}$
- $t_{\text{DEC}} \text{ (s)} \approx \frac{GD_1^2 + GD_2^2 \cdot \eta_G \text{ (kg} \cdot \text{m}^2)}{T_M - T_L \cdot \eta_G \text{ (kgf} \cdot \text{m)}} \cdot \frac{\Delta N \text{ (r/min)}}{375}$

App.F Allowable Current of Insulated Wires

The tables below list the allowable current of IV wires, HIV wires, and 600 V class of cross-linked polyethylene-insulated wires.

■ IV wires (Maximum allowable temperature: 60°C (140°F))

Table F.1 (a) Allowable Current of Insulated Wires

Wire size inch ² (mm ²)	Allowable current reference value (up to 86°F(30°C)) I _o (A)	Wiring outside duct					Wiring in the duct (Max. 3 wires in one duct)			
		35°C (95°F)	40°C (104°F)	45°C (113°F)	50°C (122°F)	55°C (131°F)	35°C (95°F)	40°C (104°F)	45°C (113°F)	50°C (122°F)
		(I _o ×0.91)	(I _o ×0.82)	(I _o ×0.71)	(I _o ×0.58)	(I _o ×0.40)	(I _o ×0.63)	(I _o ×0.57)	(I _o ×0.49)	(I _o ×0.40)
0.003 (2.0)	27	24	22	19	15	11	17	15	13	10
0.005 (3.5)	37	33	30	26	21	15	23	21	18	14
0.009 (5.5)	49	44	40	34	28	20	30	27	24	19
0.013 (8.0)	61	55	50	43	35	25	38	34	29	24
0.022 (14)	88	80	72	62	51	36	55	50	43	35
0.034 (22)	115	104	94	81	66	47	72	65	56	46
0.059 (38)	162	147	132	115	93	66	102	92	79	64
0.094 (60)	217	197	177	154	125	88	136	123	106	86
0.156 (100)	298	271	244	211	172	122	187	169	146	119
0.234 (150)	395	359	323	280	229	161	248	225	193	158
0.313 (200)	469	426	384	332	272	192	295	267	229	187
0.391 (250)	556	505	455	394	322	227	350	316	272	222
0.508 (325)	650	591	533	461	377	266	409	370	318	260
0.625 (400)	745	677	610	528	432	305	469	424	365	298
0.781 (500)	842	766	690	597	488	345	530	479	412	336
2 x 0.156 (100)	497	452	407	352	288	203	313	283	243	198
2 x 0.234 (150)	658	598	539	467	381	269	414	375	322	263
2 x 0.313 (200)	782	711	641	555	453	320	492	445	383	312
2 x 0.391 (250)	927	843	760	658	537	380	584	528	454	370
2 x 0.508 (325)	1083	985	888	768	628	444	682	617	530	433
2 x 0.625 (400)	1242	1130	1018	881	720	509	782	707	608	496
2 x 0.781 (500)	1403	1276	1150	996	813	575	883	799	687	561

■ HIV wires (Maximum allowable temperature: 75°C (167°F))

Table F.1 (b) Allowable Current of Insulated Wires

Wire size inch ² (mm ²)	Allowable current reference value (up to 86°F(30°C)) I _o (A)	Wiring outside duct					Wiring in the duct (Max. 3 wires in one duct)			
		35°C (95°F)	40°C (104°F)	45°C (113°F)	50°C (122°F)	55°C (131°F)	35°C (95°F)	40°C (104°F)	45°C (113°F)	50°C (122°F)
		(I _o ×0.91)	(I _o ×0.82)	(I _o ×0.71)	(I _o ×0.58)	(I _o ×0.40)	(I _o ×0.63)	(I _o ×0.57)	(I _o ×0.49)	(I _o ×0.40)
0.003 (2.0)	32	31	29	27	24	22	21	20	18	17
0.005 (3.5)	45	42	39	37	33	30	29	27	25	23
0.009 (5.5)	59	56	52	49	44	40	39	36	34	30
0.013 (8.0)	74	70	65	61	55	50	48	45	42	38
0.022 (14)	107	101	95	88	80	72	70	66	61	55
0.034 (22)	140	132	124	115	104	94	92	86	80	72
0.059 (38)	197	186	174	162	147	132	129	121	113	102
0.094 (60)	264	249	234	217	197	177	173	162	151	136
0.156 (100)	363	342	321	298	271	244	238	223	208	187
0.234 (150)	481	454	426	395	359	323	316	296	276	248
0.313 (200)	572	539	506	469	426	384	375	351	328	295
0.391 (250)	678	639	600	556	505	455	444	417	389	350
0.508 (325)	793	747	702	650	591	533	520	487	455	409
0.625 (400)	908	856	804	745	677	610	596	558	521	469
0.781 (500)	1027	968	909	842	766	690	673	631	589	530
2 x 0.156 (100)	606	571	536	497	452	407	397	372	347	313
2 x 0.234 (150)	802	756	710	658	598	539	526	493	460	414
2 x 0.313 (200)	954	899	844	782	711	641	625	586	547	492
2 x 0.391 (250)	1130	1066	1001	927	843	760	741	695	648	584
2 x 0.508 (325)	1321	1245	1169	1083	985	888	866	812	758	682
2 x 0.625 (400)	1515	1428	1341	1242	1130	1018	993	931	869	782
2 x 0.781 (500)	1711	1613	1515	1403	1276	1150	1122	1052	982	883

App.

- 600 V class of Cross-linked Polyethylene-insulated wires (Maximum allowable temperature: 90°C (194°F))

Table F.1 (c) Allowable Current of Insulated Wires

Wire size inch ² (mm ²)	Allowable current reference value (up to 86°F(30°C)) I ₀ (A)	Wiring outside duct					Wiring in the duct (Max. 3 wires in one duct)			
		35°C (95°F)	40°C (104°F)	45°C (113°F)	50°C (122°F)	55°C (131°F)	35°C (95°F)	40°C (104°F)	45°C (113°F)	50°C (122°F)
		(I ₀ ×0.91)	(I ₀ ×0.82)	(I ₀ ×0.71)	(I ₀ ×0.58)	(I ₀ ×0.40)	(I ₀ ×0.63)	(I ₀ ×0.57)	(I ₀ ×0.49)	(I ₀ ×0.40)
0.003 (2.0)	38	36	34	32	31	29	25	24	22	21
0.005 (3.5)	52	49	47	45	42	39	34	33	31	29
0.009 (5.5)	69	66	63	59	56	52	46	44	41	39
0.013 (8.0)	86	82	78	74	70	65	57	54	51	48
0.022 (14)	124	118	113	107	101	95	82	79	74	70
0.034 (22)	162	155	148	140	132	124	108	103	97	92
0.059 (38)	228	218	208	197	186	174	152	145	137	129
0.094 (60)	305	292	279	264	249	234	203	195	184	173
0.156 (100)	420	402	384	363	342	321	280	268	253	238
0.234 (150)	556	533	509	481	454	426	371	355	335	316
0.313 (200)	661	633	605	572	539	506	440	422	398	375
0.391 (250)	783	750	717	678	639	600	522	500	472	444
0.508 (325)	916	877	838	793	747	702	611	585	552	520
0.625 (400)	1050	1005	961	908	856	804	700	670	633	596
0.781 (500)	1187	1136	1086	1027	968	909	791	757	715	673
2 x 0.156 (100)	700	670	641	606	571	536	467	447	422	397
2 x 0.234 (150)	927	888	848	802	756	710	618	592	559	526
2 x 0.313 (200)	1102	1055	1008	954	899	844	735	703	664	625
2 x 0.391 (250)	1307	1251	1195	1130	1066	1001	871	834	787	741
2 x 0.508 (325)	1527	1462	1397	1321	1245	1169	1018	974	920	866
2 x 0.625 (400)	1751	1676	1602	1515	1428	1341	1167	1117	1055	993
2 x 0.781 (500)	1978	1894	1809	1711	1613	1515	1318	1262	1192	1122

App.G Replacement Information

When replacing Fuji conventional inverter series (FVR-C9S, FVR-C11S) with the FRENIC-Mini series, refer to the replacement information given in this section.

G.1 External dimensions comparison tables

Below is a guide that helps in using the comparison tables on the following pages.

- Mounting area /Mini (%) Allows comparing the mounting area required for the FRENIC-Mini series with that for the conventional inverter series in percentage, assuming the area for the FRENIC-Mini series to be 100%. If this value is greater than 100%, it means that the mounting area required for the FRENIC-Mini series is smaller than that of other series.
- Volume/Mini (%) Allows comparing the volume of the FRENIC-Mini series with that of the conventional inverter series in percentage, assuming the volume of the FRENIC-Mini series to be 100%. If this value is greater than 100%, it means that the volume of the FRENIC-Mini is smaller than that of other series.
- In the FRENIC-Mini columns, dimensions in hatched boxes () denote that they are smaller than those of FVR-C9S and FVR-C11S series.
- In the FVR-C11S and FVR-C9S columns, underlined and bolded dimensions denote that they are smaller than those of the FRENIC-Mini series.

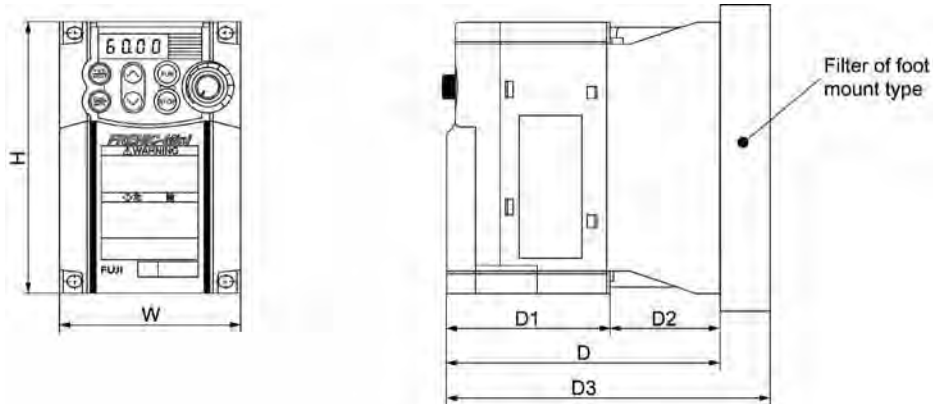

G.1.1 Standard models

FVR-C9S vs. FRENIC-Mini

Power supply voltage	Applicable motor rating (HP)	FVR-C9S (IP20) (Ambient temperature : 50°C (122°F))								FRENIC-Mini (IP20) (Ambient temperature : 50°C (122°F))							
		External dimensions : inch (mm)					Mounting area		Volume		External dimensions : inch (mm)					Mounting area	Volume
		W	H	D	D1	D2	ft ² (m ²) (x10 ⁻²)	/Mini (%)	ft ³ (m ³) (x10 ⁻³)	/Mini (%)	W	H	D	D1	D2	ft ² (m ²) (x10 ⁻²)	ft ³ (m ³) (x10 ⁻³)
3-phase 230 V	1/8	3.15 (80)	4.72 (120)	2.36 (60)	1.97 (50)	0.39 (10)	10.76 (1.0)	100.0	21.2 (0.6)	75.0	3.15 (80)	4.72 (120)	3.15 (80)	2.76 (70)	0.39 (10)	10.76 (1.0)	28.3 (0.8)
	1/4	3.15 (80)	4.72 (120)	2.56 (65)	1.97 (50)	0.59 (15)	10.76 (1.0)	100.0	21.2 (0.6)	81.3	3.15 (80)	4.72 (120)	3.15 (80)	2.76 (70)	0.39 (10)	10.76 (1.0)	28.3 (0.8)
	1/2	3.15 (80)	4.72 (120)	2.95 (75)	1.97 (50)	0.98 (25)	10.76 (1.0)	100.0	24.7 (0.7)	78.9	3.15 (80)	4.72 (120)	3.74 (95)	2.76 (70)	0.98 (25)	10.76 (1.0)	31.8 (0.9)
	1	3.15 (80)	4.72 (120)	3.94 (100)	1.97 (50)	1.97 (50)	10.76 (1.0)	100.0	35.3 (1.0)	83.3	3.15 (80)	4.72 (120)	4.72 (120)	2.76 (70)	1.97 (50)	10.76 (1.0)	42.4 (1.2)
	2	4.33 (110)	5.12 (130)	5.12 (130)	2.56 (65)	2.56 (65)	15.07 (1.4)	100.0	67.1 (1.9)	93.5	4.33 (110)	5.12 (130)	5.47 (139)	2.95 (75)	2.52 (64)	15.07 (1.4)	70.6 (2.0)
	3	4.33 (110)	5.12 (130)	5.51 (140)	2.95 (75)	2.56 (65)	15.07 (1.4)	100.0	70.6 (2.0)	100.7	4.33 (110)	5.12 (130)	5.47 (139)	2.95 (75)	2.52 (64)	15.07 (1.4)	70.6 (2.0)
	5	5.51 (140)	7.09 (180)	5.43 (138)	2.56 (65)	2.87 (73)	26.91 (2.5)	100.0	124 (3.5)	99.3	5.51 (140)	7.09 (180)	5.47 (139)	2.95 (75)	2.52 (64)	26.91 (2.5)	124 (3.5)
3-phase 460 V	1/2	-	-	-	-	-	-	-	-	-	4.33 (110)	5.12 (130)	4.53 (115)	2.95 (75)	1.58 (40)	15.07 (1.4)	56.5 (1.6)
	1	-	-	-	-	-	-	-	-	-	4.33 (110)	5.12 (130)	5.47 (139)	2.95 (75)	2.52 (64)	15.07 (1.4)	70.6 (2.0)
	2	-	-	-	-	-	-	-	-	-	4.33 (110)	5.12 (130)	5.47 (139)	2.95 (75)	2.52 (64)	15.07 (1.4)	70.6 (2.0)
	3	-	-	-	-	-	-	-	-	-	4.33 (110)	5.12 (130)	5.47 (139)	2.95 (75)	2.52 (64)	15.07 (1.4)	70.6 (2.0)
	5	-	-	-	-	-	-	-	-	-	5.51 (140)	7.09 (180)	5.47 (139)	2.95 (75)	2.52 (64)	26.91 (2.5)	124 (3.5)
1-phase 230 V	1/8	3.15 (80)	4.72 (120)	3.37 (85.5)	2.97 (75.5)	0.39 (10)	10.76 (1.0)	100.0	28.3 (0.8)	106.9	3.15 (80)	4.72 (120)	3.15 (80)	2.76 (70)	0.39 (10)	10.76 (1.0)	28.3 (0.8)
	1/4	3.15 (80)	4.72 (120)	3.56 (90.5)	2.97 (75.5)	0.59 (15)	10.76 (1.0)	100.0	31.8 (0.9)	113.1	3.15 (80)	4.72 (120)	3.15 (80)	2.76 (70)	0.39 (10)	10.76 (1.0)	28.3 (0.8)
	1/2	3.15 (80)	4.72 (120)	3.96 (100.5)	2.97 (75.5)	0.98 (25)	10.76 (1.0)	100.0	35.3 (1.0)	105.8	3.15 (80)	4.72 (120)	3.74 (95)	2.76 (70)	0.98 (25)	10.76 (1.0)	31.8 (0.9)
	1	3.15 (80)	4.72 (120)	5.53 (140.5)	3.56 (90.5)	1.97 (50)	10.76 (1.0)	100.0	45.9 (1.3)	100.4	3.15 (80)	4.72 (120)	5.51 (140)	3.54 (90)	1.97 (50)	10.76 (1.0)	45.9 (1.3)
	2	4.33 (110)	5.12 (130)	5.53 (140.5)	2.97 (75.5)	2.56 (65)	15.07 (1.4)	100.0	70.6 (2.0)	94.3	4.33 (110)	5.12 (130)	5.87 (149)	3.35 (85)	2.52 (64)	15.07 (1.4)	74.2 (2.1)
	3	-	-	-	-	-	-	-	-	-	5.51 (140)	7.09 (180)	5.47 (139)	2.95 (75)	2.52 (64)	26.91 (2.5)	124 (3.5)
	5	-	-	-	-	-	-	-	-	-	-	-	-	-	-	-	-

FVR-C11S vs. FRENIC-Mini

Power supply voltage	Applicable motor rating (HP)	FVR-C11S (IP20) (Ambient temperature : 50°C (122°F))								FRENIC-Mini (IP20) (Ambient temperature : 50°C (122°F))							
		External dimensions : inch (mm)					Mounting area		Volume		External dimensions : inch (mm)					Mounting area	Volume
		W	H	D	D1	D2	ft ² (m ²) (x10 ⁻²)	/Mini (%)	ft ³ (m ³) (x10 ⁻³)	/Mini (%)	W	H	D	D1	D2	ft ² (m ²) (x10 ⁻²)	ft ³ (m ³) (x10 ⁻³)
3-phase 230 V	1/8	3.15 (80)	4.72 (120)	3.15 (80)	2.76 (70)	0.39 (10)	10.76 (1.0)	100.0	28.3 (0.8)	100.0	3.15 (80)	4.72 (120)	3.15 (80)	2.76 (70)	0.39 (10)	10.76 (1.0)	28.3 (0.8)
	1/4	3.15 (80)	4.72 (120)	3.35 (85)	2.76 (70)	0.59 (15)	10.76 (1.0)	100.0	28.3 (0.8)	106.3	3.15 (80)	4.72 (120)	3.15 (80)	2.76 (70)	0.39 (10)	10.76 (1.0)	28.3 (0.8)
	1/2	3.15 (80)	4.72 (120)	3.74 (95)	2.76 (70)	0.98 (25)	10.76 (1.0)	100.0	31.8 (0.9)	100.0	3.15 (80)	4.72 (120)	3.74 (95)	2.76 (70)	0.98 (25)	10.76 (1.0)	31.8 (0.9)
	1	3.15 (80)	4.72 (120)	4.72 (120)	2.76 (70)	1.97 (50)	10.76 (1.0)	100.0	42.4 (1.2)	100.0	3.15 (80)	4.72 (120)	4.72 (120)	2.76 (70)	1.97 (50)	10.76 (1.0)	42.4 (1.2)
	2	4.33 (110)	5.12 (130)	5.47 (139)	2.95 (75)	2.52 (64)	15.07 (1.4)	100.0	70.6 (2.0)	100.0	4.33 (110)	5.12 (130)	5.47 (139)	2.95 (75)	2.52 (64)	15.07 (1.4)	70.6 (2.0)
	3	4.33 (110)	5.12 (130)	5.47 (139)	2.95 (75)	2.52 (64)	15.07 (1.4)	100.0	70.6 (2.0)	100.0	4.33 (110)	5.12 (130)	5.47 (139)	2.95 (75)	2.52 (64)	15.07 (1.4)	70.6 (2.0)
	5	5.51 (140)	7.09 (180)	5.39 (137)	2.56 (65)	2.84 (72)	26.91 (2.5)	100.0	124 (3.5)	98.6	5.51 (140)	7.09 (180)	5.47 (139)	2.95 (75)	2.52 (64)	26.91 (2.5)	124 (3.5)
3-phase 460 V	1/2	-	-	-	-	-	-	-	-	-	4.33 (110)	5.12 (130)	4.528 (115)	2.95 (75)	1.58 (40)	15.07 (1.4)	56.5 (1.6)
	1	-	-	-	-	-	-	-	-	-	4.33 (110)	5.12 (130)	5.472 (139)	2.95 (75)	2.52 (64)	15.07 (1.4)	70.6 (2.0)
	2	-	-	-	-	-	-	-	-	-	4.33 (110)	5.12 (130)	5.472 (139)	2.95 (75)	2.52 (64)	15.07 (1.4)	70.6 (2.0)
	3	-	-	-	-	-	-	-	-	-	4.33 (110)	5.12 (130)	5.472 (139)	2.95 (75)	2.52 (64)	15.07 (1.4)	70.6 (2.0)
	5	-	-	-	-	-	-	-	-	-	5.51 (140)	7.09 (180)	5.472 (139)	2.95 (75)	2.52 (64)	26.91 (2.5)	124 (3.5)
1-phase 230 V	1/8	3.15 (80)	4.72 (120)	3.15 (80)	2.76 (70)	0.39 (10)	10.76 (1.0)	100.0	28.3 (0.8)	100.0	3.15 (80)	4.72 (120)	3.15 (80)	2.76 (70)	0.39 (10)	10.76 (1.0)	28.3 (0.8)
	1/4	3.15 (80)	4.72 (120)	3.35 (85)	2.76 (70)	0.59 (15)	10.76 (1.0)	100.0	28.3 (0.8)	106.3	3.15 (80)	4.72 (120)	3.15 (80)	2.76 (70)	0.39 (10)	10.76 (1.0)	28.3 (0.8)
	1/2	3.15 (80)	4.72 (120)	4.53 (115)	3.54 (90)	0.98 (25)	10.76 (1.0)	100.0	38.8 (1.1)	121.1	3.15 (80)	4.72 (120)	3.74 (95)	2.76 (70)	0.98 (25)	10.76 (1.0)	31.8 (0.9)
	1	3.15 (80)	4.72 (120)	5.51 (140)	3.54 (90)	1.97 (50)	10.76 (1.0)	100.0	45.9 (1.3)	100.0	3.15 (80)	4.72 (120)	5.51 (140)	3.54 (90)	1.97 (50)	10.76 (1.0)	45.9 (1.3)
	2	4.33 (110)	5.12 (130)	5.87 (149)	3.35 (85)	2.52 (64)	15.07 (1.4)	100.0	74.2 (2.1)	100.0	4.33 (110)	5.12 (130)	5.866 (149)	3.35 (85)	2.52 (64)	15.07 (1.4)	74.2 (2.1)
	3	5.51 (140)	7.09 (180)	5.39 (137)	2.56 (65)	2.84 (72)	26.91 (2.5)	100.0	124 (3.5)	98.6	5.51 (140)	7.09 (180)	5.472 (139)	2.95 (75)	2.52 (64)	26.91 (2.5)	124 (3.5)
	5	-	-	-	-	-	-	-	-	-	-	-	-	-	-	-	-

G.1.2 Models available on order

[1] EMC filter built-in type

In the European version, the EMC filter built-in type is provided as a standard model. In other versions, it is available on order.

FVR-C9S vs. FRENIC-Mini

		FVR-C9S (IP20) (Standard unit with a foot-mount filter) (Ambient temperature : 50°C (122°F))									FRENIC-Mini (Planning values) (IP20) (Ambient temperature : 50°C (122°F))						
Power supply voltage	Applicable motor rating (HP)	External dimensions : inch (mm)					Mounting area		Volume		External dimensions : inch (mm)					Mounting area	Volume
		W	H	D	D1	D2	ft ² (m ²) (x10 ⁻²)	/Mini (%)	ft ³ (m ³) (x10 ⁻³)	/Mini (%)	W	H	D	D1	D2	ft ² (m ²) (x10 ⁻²)	ft ³ (m ³) (x10 ⁻³)
3-phase 230 V	1/8	-	-	-	-	-	-	-	-	-	3.15 (80)	4.72 (120)	3.94 (100)	3.54 (90)	0.39 (10)	10.76 (1.0)	35.31 (1.0)
	1/4	-	-	-	-	-	-	-	-	-	3.15 (80)	4.72 (120)	3.94 (100)	3.54 (90)	0.39 (10)	10.76 (1.0)	35.31 (1.0)
	1/2	-	-	-	-	-	-	-	-	-	3.15 (80)	4.72 (120)	4.53 (115)	3.54 (90)	0.98 (25)	10.76 (1.0)	38.84 (1.1)
	1	-	-	-	-	-	-	-	-	-	3.15 (80)	4.72 (120)	5.51 (140)	3.543 (90)	1.97 (50)	10.76 (1.0)	45.91 (1.3)
	2	-	-	-	-	-	-	-	-	-	5.51 (140)	7.09 (180)	7.17 (182)	4.65 (118)	2.52 (64)	26.91 (2.5)	162 (4.6)
	3	-	-	-	-	-	-	-	-	-	5.51 (140)	7.09 (180)	7.17 (182)	4.65 (118)	2.52 (64)	26.91 (2.5)	162 (4.6)
	5	-	-	-	-	-	-	-	-	-	5.51 (140)	7.09 (180)	7.17 (182)	4.65 (118)	2.52 (64)	26.91 (2.5)	162 (4.6)
3-phase 460 V	1/2	-	-	-	-	-	-	-	-	-	4.33 (110)	5.118 (130)	6.22 (158)	4.646 (118)	1.58 (40)	15.07 (1.4)	81.22 (2.3)
	1	-	-	-	-	-	-	-	-	-	4.33 (110)	5.118 (130)	7.17 (182)	4.65 (118)	2.52 (64)	15.07 (1.4)	91.81 (2.6)
	2	-	-	-	-	-	-	-	-	-	5.51 (140)	7.09 (180)	7.17 (182)	4.65 (118)	2.52 (64)	26.91 (2.5)	162 (4.6)
	3	-	-	-	-	-	-	-	-	-	5.51 (140)	7.09 (180)	7.17 (182)	4.65 (118)	2.52 (64)	26.91 (2.5)	162 (4.6)
	5	-	-	-	-	-	-	-	-	-	5.51 (140)	7.09 (180)	7.17 (182)	4.65 (118)	2.52 (64)	26.91 (2.5)	162 (4.6)
1-phase 230 V	1/8	3.35 (85)	6.69 (170)	4.74 (120.5)	-	-	15.07 (1.4)	150.5	60.03 (1.7)	181.4	3.15 (80)	4.72 (120)	3.94 (100)	3.54 (90)	0.39 (10)	10.76 (1.0)	35.31 (1.0)
	1/4	3.35 (85)	6.69 (170)	4.94 (125.5)	-	-	15.07 (1.4)	150.5	63.56 (1.8)	188.9	3.15 (80)	4.72 (120)	3.94 (100)	3.54 (90)	0.39 (10)	10.76 (1.0)	35.31 (1.0)
	1/2	3.35 (85)	6.69 (170)	5.34 (135.5)	-	-	15.07 (1.4)	150.5	70.63 (2.0)	177.4	3.15 (80)	4.72 (120)	4.53 (115)	3.54 (90)	0.98 (25)	10.76 (1.0)	38.84 (1.1)
	1	3.35 (85)	6.69 (170)	6.91 (175.5)	-	-	15.07 (1.4)	101.0	88.28 (2.5)	127.6	4.33 (110)	5.12 (130)	5.47 (139)	3.90 (99)	1.97 (50)	15.07 (1.4)	70.63 (2.0)
	2	4.53 (115)	7.09 (180)	6.91 (175.5)	-	-	22.60 (2.1)	82.1	127 (3.6)	79.2	5.51 (140)	7.09 (180)	7.17 (182)	4.65 (118)	2.52 (64)	26.91 (2.5)	162 (4.6)
	3	-	-	-	-	-	-	-	-	-	5.51 (140)	7.09 (180)	7.17 (182)	4.65 (118)	2.52 (64)	26.91 (2.5)	162 (4.6)

Note: In the FRENIC-Mini columns, dimensions in bold boxes denote that they are greater than those of standard models.

App.

FVR-C11S vs. FRENIC-Mini

		FVR-C11S (IP20) (Standard unit with a foot-mount filter) (Ambient temperature : 50°C (122°F))									FRENIC-Mini (Planning values) (IP20) (Ambient temperature : 50°C (122°F))						
Power supply voltage	Applicable motor rating (HP)	External dimensions : inch (mm)					Mounting area		Volume		External dimensions : inch (mm)					Mounting area	Volume
		W	H	D	D1	D2	ft ² (m ²) (x10 ⁻²)	/Mini (%)	ft ³ (m ³) (x10 ⁻³)	/Mini (%)	W	H	D	D1	D2	ft ² (m ²) (x10 ⁻²)	ft ³ (m ³) (x10 ⁻³)
3-phase 230 V	1/8	-	-	-	-	-	-	-	-	-	3.15 (80)	4.72 (120)	3.94 (100)	3.54 (90)	0.39 (10)	10.76 (1.0)	35.31 (1.0)
	1/4	-	-	-	-	-	-	-	-	-	3.15 (80)	4.72 (120)	3.94 (100)	3.54 (90)	0.39 (10)	10.76 (1.0)	35.31 (1.0)
	1/2	-	-	-	-	-	-	-	-	-	3.15 (80)	4.72 (120)	4.53 (115)	3.54 (90)	0.98 (25)	10.76 (1.0)	38.84 (1.1)
	1	-	-	-	-	-	-	-	-	-	3.15 (80)	4.72 (120)	5.51 (140)	3.543 (90)	1.97 (50)	10.76 (1.0)	45.91 (1.3)
	2	-	-	-	-	-	-	-	-	-	5.51 (140)	7.09 (180)	7.17 (182)	4.65 (118)	2.52 (64)	26.91 (2.5)	162 (4.6)
	3	-	-	-	-	-	-	-	-	-	5.51 (140)	7.09 (180)	7.17 (182)	4.65 (118)	2.52 (64)	26.91 (2.5)	162 (4.6)
	5	-	-	-	-	-	-	-	-	-	5.51 (140)	7.09 (180)	7.17 (182)	4.65 (118)	2.52 (64)	26.91 (2.5)	162 (4.6)
3-phase 460 V	1/2	-	-	-	-	-	-	-	-	-	4.33 (110)	5.118 (130)	6.22 (158)	4.646 (118)	1.58 (40)	15.07 (1.4)	81.22 (2.3)
	1	-	-	-	-	-	-	-	-	-	4.33 (110)	5.118 (130)	7.17 (182)	4.65 (118)	2.52 (64)	15.07 (1.4)	91.81 (2.6)
	2	-	-	-	-	-	-	-	-	-	5.51 (140)	7.09 (180)	7.17 (182)	4.65 (118)	2.52 (64)	26.91 (2.5)	162 (4.6)
	3	-	-	-	-	-	-	-	-	-	5.51 (140)	7.09 (180)	7.17 (182)	4.65 (118)	2.52 (64)	26.91 (2.5)	162 (4.6)
	5	-	-	-	-	-	-	-	-	-	5.51 (140)	7.09 (180)	7.17 (182)	4.65 (118)	2.52 (64)	26.91 (2.5)	162 (4.6)
1-phase 230 V	1/8	3.39 (86)	6.69 (170)	4.61 (117)	-	-	16.15 (1.5)	152.3	60.03 (1.7)	178.2	3.15 (80)	4.7 (120)	3.94 (100)	3.54 (90)	0.39 (10)	10.76 (1.0)	35.31 (1.0)
	1/4	3.39 (86)	6.69 (170)	4.80 (122)	-	-	16.15 (1.5)	152.3	63.56 (1.8)	185.8	3.15 (80)	4.72 (120)	3.94 (100)	3.54 (90)	0.39 (10)	10.76 (1.0)	35.31 (1.0)
	1/2	3.39 (86)	6.6 (170)	5.98 (152)	-	-	16.15 (1.5)	152.3	77.69 (2.2)	201.3	3.15 (80)	4.72 (120)	4.53 (115)	3.54 (90)	0.98 (25)	10.76 (1.0)	38.84 (1.1)
	1	3.39 (86)	6.69 (170)	6.97 (177)	-	-	16.15 (1.5)	102.2	91.81 (2.6)	130.2	4.33 (110)	5.12 (130)	5.47 (139)	3.90 (99)	1.97 (50)	15.07 (1.4)	70.63 (2.0)
	2	4.57 (116)	7.09 (180)	7.56 (192)	-	-	22.60 (2.1)	82.9	141 (4.0)	87.4	5.51 (140)	7.09 (180)	7.17 (182)	4.65 (118)	2.52 (64)	26.91 (2.5)	162 (4.6)
	3	5.83 (148)	9.06 (230)	7.21 (183)	-	-	36.60 (3.4)	135.1	218 (6.2)	135.8	5.51 (140)	7.09 (180)	7.17 (182)	4.65 (118)	2.52 (64)	26.91 (2.5)	162 (4.6)

Note: In the FRENIC-Mini columns, dimensions in bold boxes denote that they are greater than those of standard models.

[2] Baking resistor built-in type

This model has the same dimensions as standard models listed in Section G.1.1.

G.2 Terminal arrangements and symbols

This section shows the difference in the terminal arrangements and their symbols between the FRENIC-Mini series and the replaceable inverter series.

When replacing the conventional series with the FRENIC-Mini series, be careful with the wiring direction that may also differ depending upon models

FVR-C9S vs. FRENIC-Mini

FVR-C9S

Three-phase 230V 1/8 to 5 HP

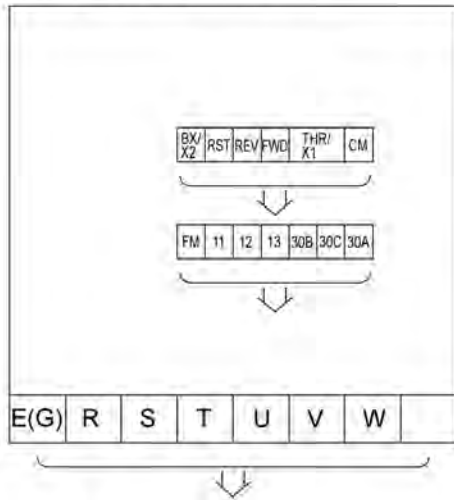

↙ : Direction of wire guide

FRENIC-Mini

Three-phase 230V 1/8 to 1 HP

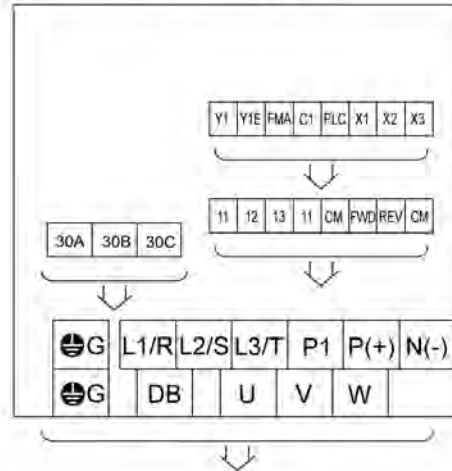

Three-phase 230V 2 to 5 HP

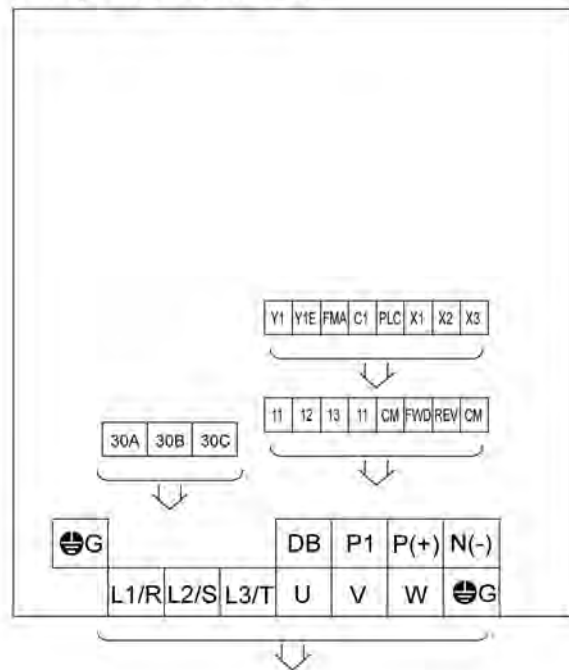

App.

FVR-C11S vs. FRENIC-Mini

FVR-C11S

Three-phase 230 V 1/8 to 5 HP

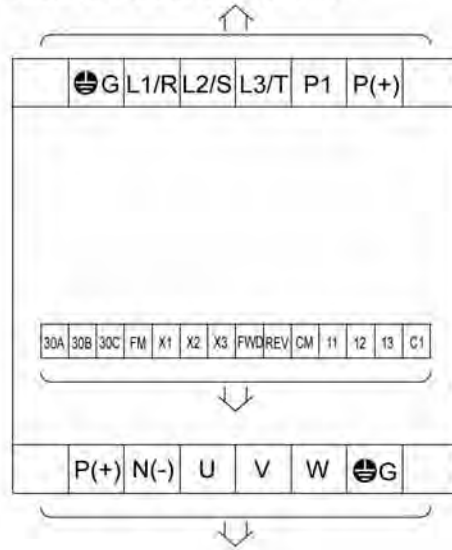

FRENIC-Mini

Three-phase 230 V 1/8 to 1 HP

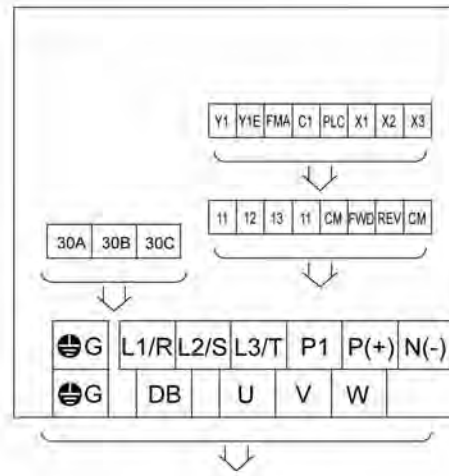

Three-phase 230 V 2 to 5 HP

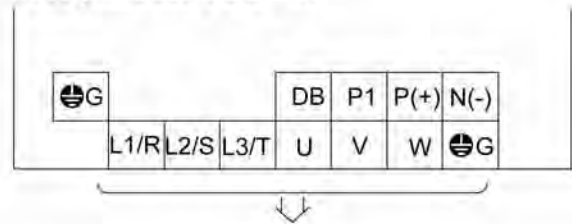

Single-phase 230 V 1/8 to 3 HP

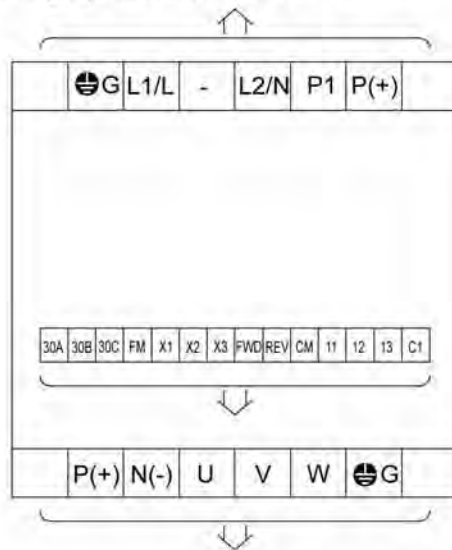

Single-phase 230 V 1/8 to 1 HP

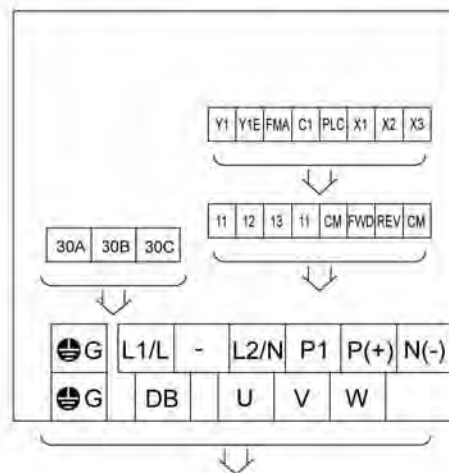

Single-phase 230 V 2,3 HP

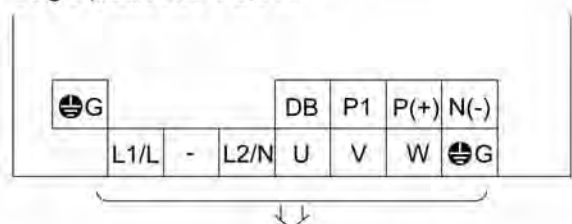

↑ ↓: Direction of wire guide

G.3 Function codes

This section describes the replacement information related to function codes that are required when replacing the conventional inverter series (e.g., FVR-C9S and FVR-C11S) with the FRENIC-Mini series. It also provides the conversion table for the torque boost setting.

FVR-C9S vs. FRENIC-Mini

FVR-C9S		FRENIC-Mini		Remarks
Function code	Name	Function code	Name	
F00	Data protection	F00	Data Protection	
F01	Frequency command	F01	Frequency Command Source 1	
F02	Operation method	F02	RUN Command Source	
F03	Maximum frequency	F03	Maximum Frequency	
F04	Base frequency	F04	Base Frequency	
F05	Acceleration time	F07	Acceleration Time 1	
F06	Deceleration time	F08	Deceleration Time 1	
F07	Torque boost	F09	Torque Boost	The data implements other function. For details, refer to the torque boost setting conversion table on page A-33.
		F37	Load Selection/Auto Torque Boost/Auto Energy Saving Operation	Select the reduced/constant torque using F37.
F08	Electronic thermal overload relay (Select)	F10	Electronic Thermal Motor Overload Protection (Select motor characteristics)	Select "Disable" using F11 (= 0.00) instead of F10.
F09	Electronic thermal overload relay (Level)	F11	Electronic Thermal Motor Overload Protection (Overload detection current)	
		F12	Electronic Thermal Motor Overload Protection (Thermal time constant)	Set the data at 1.0min.
F10	Restart mode after momentary power failure (Select)	F14	Restart after Instantaneous Power Failure	F10=0/F10=1 is equivalent to F14=1/F14=4.
F11	Frequency setting gain	C32	Analog Input Adjustment (Gain for terminal input [12]) (Gain)	Analog input is applied to [12] so that the gain for set frequency is equal to the gain for [12]. Setting differs each other. Refer to Chapter 9 "FUNCTION CODES" for details.
		C34	Analog Input Adjustment (Gain for terminal input [12]) (Gain reference point)	
F26	Bias frequency	F18	Bias (for Frequency Command 1, F01)	
		C50	Bias (Frequency command 1) (Bias reference point)	
F12	DC brake (Braking current)	F21	DC Braking (Braking level)	
F13	DC brake (Braking time)	F22	DC Braking (Braking time)	
		F20	DC Braking (Start frequency)	Set at 3 Hz.
F14	Starting frequency	F23	Start Frequency	
F15	Motor sound	F26	Motor Sound (Carrier frequency)	F15=0 to 5 sets the carrier frequency at 2.5 to 15kHz equivalently. Check the motor sound and select the frequency correctly.
F16	Alarm history			Check the alarm information from the keypad. Refer to Chapter 3 for details.
F17	Data initializing	H03	Data Initialization (Data reset)	
F18	Auto-reset	H04	Retry (No. of retries)	When the retry is enabled (F18=1), set H04=5/H05=0.5s.
		H05	Retry (Latency time)	
F19	Motor Characteristics			No function code with same feature. No setting required.
F20	Jump frequency width	C04	Jump Frequency Band	
F21	Jump frequency 1	C01	Jump Frequency 1	
F22	Jump frequency 2	C02	Jump Frequency 2	
F23	Jump frequency 3	C03	Jump Frequency 3	
F24	Peak frequency	F15	Frequency Limiter (High)	
F25	Bottom frequency	F16	Frequency Limiter (Low)	
F27	THR terminal function	E01	X1 Terminal Function	Assign (THR) to the terminal [X1]. If F27=0, set E01=9, if F27=1, set E01=0.
F28	BX terminal function	E02	X2 Terminal Function	Assign (BX) to the terminal [X2]. If F28=0, set E02=7, if F28=1, set E02=1.
F29	Multistep frequency setting 1	C05	Multistep Frequency Settings 1	
F30	Multistep frequency setting 2	C06	Multistep Frequency Settings 2	
F31	Multistep frequency setting 3	C07	Multistep Frequency Settings 3	
F32	FM terminal (Voltage adjustment)	F30	Terminal [FMA] (Gain to output voltage)	The data has different feature each other. Readjust the meter.
F33	FM terminal (Select)	F31	Terminal [FMA] (Monitor object)	When selecting the output frequency (F33=0), set F31=0. If the output current (F33=1), set F31=2.

FVR-C11S vs. FRENIC-Mini

FVR-C11S		FRENIC-Mini		Remarks
Function code	Name	Function code	Name	
F00	Data protection	F00	Data Protection	
F01	Frequency command	F01	Frequency Command Source 1	
F02	Operation method	F02	RUN Command Source	
F03	Maximum frequency	F03	Maximum Frequency	
F04	Base frequency	F04	Base Frequency	
F07	Acceleration time	F07	Acceleration Time 1	
F08	Deceleration time	F08	Deceleration Time 1	
F09	Torque boost	F09	Torque Boost	The data implements other function. For details, refer to the torque boost setting conversion table on page A-33. Select the reduced/constant torque using F37.
		F37	Load Selection/Auto Torque Boost/Auto Energy Saving Operation	
F10	Electronic thermal overload relay (Select)	F10	Electronic Thermal Motor Overload Protection (Select motor characteristics)	Select "Disable" using F11 (= 0.00) instead of F10.
F11	Electronic thermal overload relay (Level)	F11	Electronic Thermal Motor Overload Protection (Overload detection current)	
F12	Electronic thermal overload relay	F12	Electronic Thermal Motor Overload Protection (Thermal time constant)	
F14	Restart mode after momentary power failure (Select)	F14	Restart after Instantaneous Power Failure	Replace the data of FVR-C11S from 2 to 4 of FRENIC-Mini and from 3 to 5.
F15	Frequency limiter (Peak)	F15	Frequency Limiter (High)	
F16	Frequency limiter (Bottom)	F16	Frequency Limiter (Low)	
F17	Gain (Frequency setting)	C32	Analog Input Adjustment (Gain for terminal input [12]) (Gain)	Analog input is applied to [12] so that the gain for set frequency is equal to the gain for [12]. Setting differs each other. Refer to Chapter 9 "FUNCTION CODES" for details.
		C34	Analog Input Adjustment (Gain for terminal input [12]) (Gain reference point)	
F18	Bias frequency	F18	Bias (for Frequency Command 1, F01)	
		C50	Bias (Frequency command 1) (Bias reference point)	
F20	DC brake (Starting freq.)	F20	DC Braking (Start frequency)	Set at 3 Hz.
F21	DC brake (Braking level)	F21	DC Braking (Braking level)	
F22	DC brake (Braking time)	F22	DC Braking (Braking time)	
F23	Starting frequency	F23	Start Frequency	
F25	Stop frequency	F25	Stop Frequency	
F26	Motor sound (Carrier freq.)	F26	Motor Sound (Carrier frequency)	
F27	Motor sound (Sound tone)	F27	Motor Sound (Sound tone)	
F30	FM terminal (Voltage adjustment)	F30	Terminal [FMA] (Gain to output voltage)	
F31	FM terminal (Select)	F31	Terminal [FMA] (Monitor object)	The selection for the data differs each other. For details refer to Chapter 9 "FUNCTION CODES."
F36	30Ry operation mode	E27	[30A/B/C] Terminal Function (Mechanical relay contacts)	If F36=0, set E27=99, if F36=1, set E27=1099.
E01	X1 terminal function (Select)	E01	X1 Terminal Function	The selection for the data differs each other. For details refer to Chapter 9 "FUNCTION CODES."
E02	X2 terminal function (Select)	E02	X2 Terminal Function	
E03	X3 terminal function (Select)	E03	X3 Terminal Function	
C01	Jump frequency 1	C01	Jump Frequency 1	
C02	Jump frequency 2	C02	Jump Frequency 2	
C03	Jump frequency 3	C03	Jump Frequency 3	
C04	Jump frequency (Hysteresis)	C04	Jump Frequency Band	
C05	Multistep frequency setting 1	C05	Multistep Frequency Settings 1	
C06	Multistep frequency setting 2	C06	Multistep Frequency Settings 2	
C07	Multistep frequency setting 3	C07	Multistep Frequency Settings 3	
P00	Motor Characteristics			No function code with same feature. No setting required.
H01	Operation time			Check the alarm information from the keypad. Refer to Chapter 3 for details.
H02	Trip history			Check the alarm information from the keypad. Refer to Chapter 3 for details.
H03	Data initializing	H03	Data Initialization (Data reset)	
H04	Auto-reset (Times)	H04	Retry (No. of retries)	If the retry is disabled, set 0. If enabled, set 5times.
		H05	Retry (Latency time)	

FVR-C11S		FRENIC-Mini		Remarks
Function code	Name	Function code	Name	
H06	Fan stop operation	H06	Cooling Fan ON/OFF	
H20	PID control (Select)	J01	PID Control	
H21	PID control (Feedback signal select)	E61	Terminal [12] (Function selection)	To select the [12] as the feedback set the data of 5.
		E62	Terminal [C1](Function selection)	To select the [C1] as the feedback set the data of 5.
		C32	Analog Input Adjustment (Gain for terminal input [12]) (Gain)	When the frequency is commanded in 1-5V, select the [12] and set the C32 (analog input gain) for 200%. Use it as 0-5V range.
H22	PID control P (gain)	J03	PID control P (gain)	
H23	PID control I (Integration time)	J04	PID control I (Integration time)	
H24	PID control D (Differentiation time)	J05	PID control D (Differentiation time)	
H25	PID control (Feedback filter)	J06	PID control (Feedback filter)	
o00	Option select (RS-485)	y10	RS-485 (Protocol selection)	Select 2 (Fuji general-purpose protocol).
o01	Station address	y01	RS-485 (Station address)	
o02	Mode select on no response error	y02	RS-485 (Mode selection on no response error)	
o03	Timer	y03	RS-485 (Timer)	
o04	Baud rate	y04	RS-485 (Transmission speed)	1200 bps is not supported.
o05	Data length	y05	RS-485 (Data length)	
o06	Parity check	y06	RS-485 (Parity check)	
o07	Stop bits	y07	RS-485 (Stop bits)	
o08	No response error detection time	y08	RS-485 (No response error detection time)	
o09	Response interval	y09	RS-485 (Response interval)	
o10	RS-485 command select (Frequency setting)	H30	Communications Link (Function selection)	For details of the data compatibility, refer to Chapter 9 "FUNCTION CODES."
o11	RS-485 command select (Running command)			

Conversion Table for Setting Torque Boost

Inverter Series Name Func. Codes	FVR-C9S FVR-C11S	FRENIC-Mini	
	F09	F09	F37
Data	0	0	0
	1	None, Consult us.	
	2	0	1
	3	0.2	1
	4	0.8	1
	5	1.5	1
	6	2.3	1
	7	3.1	1
	8	3.9	1
	9	4.7	1
	10	5.5	1
	11	6.3	1
	12	7.2	1
	13	8	1
	14	8.9	1
	15	9.8	1
	16	10.6	1
	17	11.5	1
	18	12.5	1
	19	13.2	1
	20	14.1	1
	21	15	1
	22	15.8	1
	23	16.7	1
	24	17.5	1
	25	18.3	1
	26	19.2	1
	27	20	1
	28	20	1
	29	20	1
	30	20	1
31	20	1	

Glossary

This glossary explains the technical terms that are frequently used in this manual.

Acceleration time

Period required when an inverter accelerates its output from 0 Hz to the output frequency.

Related function codes: F03, F07, E10, and H54

Alarm mode

One of the three operation modes supported by the inverter. If the inverter detects any malfunction, error, or fault in its operation, it immediately shuts down or trips the output to the motor and enters this mode in which corresponding alarm codes are displayed on the LED monitor.

Alarm output (for any faults)

A mechanical contact output signal that is generated when the inverter is halted by an alarm, by short-circuiting between terminals [30A] and [30C].

Related function code: E27

See Alarm mode.

Analog input

An external voltage or current input signal to give the inverter the frequency command. The analog voltage is applied on the terminal [11], the current on the [C1]. These terminals are also used to input the signal from the external potentiometer, PTC and PID feedback signals depending on the function code definition.

Related function codes: F01, C30, E60 to E62 and J02

Analog output

An analog DC output signal of the monitored data such as the output frequency, the current and voltage inside an inverter. The signal drive an analog meter installed outside the inverter for indicating the current inverter running status.

Refer to Chapter 8, Section 8.4.1 "Terminal functions."

Applicable motor rating

Rated output (in kW) of a general-purpose motor that is used as a standard motor listed in tables in Chapter 6, "SELECTING PERIPHERAL EQUIPMENT" and Chapter 8, "SPECIFICATIONS."

Automatic deceleration

A control mode in which deceleration time is automatically extended up to 3 times of the commanded time to prevent the inverter from tripping due to an overvoltage caused by regenerative power even if a braking resistor is used.

Related function code: H69

Automatic energy saving operation

Energy saving operation that automatically drives the motor with lower output voltage when the motor load has been light, for minimizing the product of voltage and current (electric power).

Related function code: F37

AVR (Automatic Voltage Regulator) control

A control that keeps an output voltage constant regardless to variations of the input source voltage or load.

Base frequency

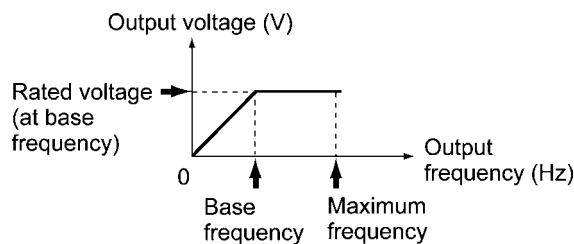

The minimum frequency at which an inverter delivers a constant voltage in the output V/f pattern. Related function code: F04

Bias

A value to be added to an analog input frequency to modify and produce the output frequency.

Related function codes: F18, C50 to C52

Braking torque

Torque that acts in a direction that will stop a rotating motor (or the force required to stop a running motor).

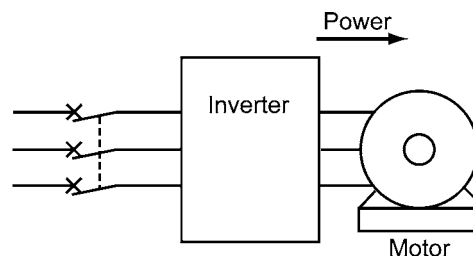

During accelerating or running at constant speed

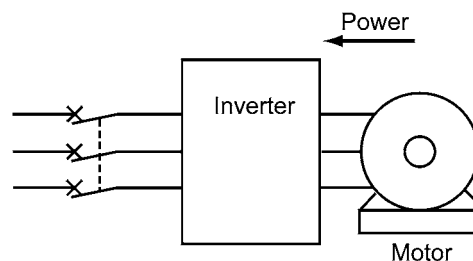

During decelerating

If a deceleration time is shorter than the natural stopping time (coast-to-stop) determined by a moment of inertia for a load machine, then the motor works as a generator when it decelerates, causing the kinetic energy of the load to be converted to electrical energy that is returned to the inverter from the motor. If this power (regenerative power) is consumed or accumulated by the inverter, the motor generates a braking force called "braking torque."

Carrier frequency

Frequency used to modulate a modulated frequency to establish the modulation period of a pulse width under the PWM control system. The higher the carrier frequency, the closer the inverter output current approaches a sinusoidal waveform and the quieter the motor becomes.

Related function code: F26

Coast-to-stop

If the inverter stops its output when the motor is running, the motor will coast to a stop due to inertial force.

Communications link function

A feature to control an inverter from external equipment serially linked to the inverter such as a PC or PLC.

Related function code: H30

Constant feeding rate time

Time required for an object to move in a constant distance previously defined. The faster speed, the shorter time and vice versa. This facility may be applied to a chemical process that determines a processing time of materials as the speed such as heating, cooling, drying, or doping in some constant-speed machinery.

Related function codes: E39 and E50.

Constant output load

A constant output load is characterized by:

- 1) The required torque is in inverse proportion to the load r/min
- 2) An essentially constant power requirement

Related function code: F37

Applications: Machine tool spindles

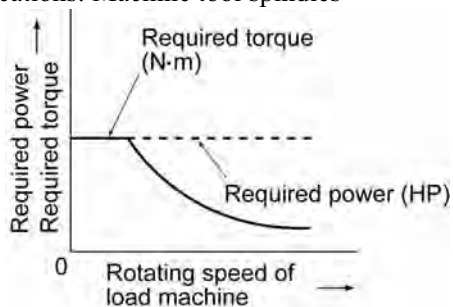

Constant torque load

A constant torque load is characterized by:

- 1) A requirement for an essentially constant torque, regardless of the r/min
- 2) A power requirement that decreases in proportion to the r/min

Related function code: F37

Applications: Conveyors, elevators, and transport machines

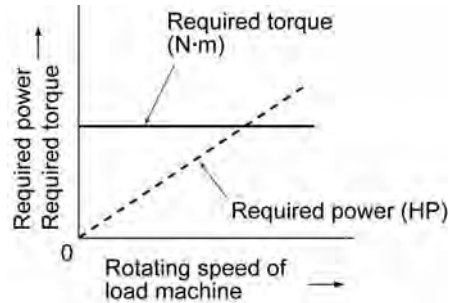

Control circuit terminals

Terminals on the inverter, which are used for input/output of signals to control or manage the inverter/external equipment directly or indirectly

Current limiter

A device that keeps an inverter output frequency within the specified current limit.

Cursor

Marker blinking on the four-digit, 7-segment LED monitor which shows that data in the blinking digit can be changed/modified by keying operation.

Curvilinear V/f pattern

A generic name for the inverter output patterns with curvilinear relation between the frequency and voltage.

Refer to function code H07 in Chapter 9, Section 9.2.5 "H codes."

DC braking (DC injection braking)

DC current braking that an inverter injects into the motor to brake and stop it against the moment of inertia of the motor or its load. The inertial energy generated is consumed as heat in the motor.

If a motor having the load with large moment of inertia is going to stop abruptly, the moment of inertia may force to rotate the motor after the inverter output frequency has been reduced to 0 Hz. Use DC injection braking to stop the motor completely.

Related function codes: F20 and F21

DC link bus voltage

Voltage at the DC link bus that is the end stage of the converter part of inverters. The part rectifies the input AC power to charge the DC link bus capacitor/s as the DC power to be inverted to AC power.

Deceleration time

Period during which an inverter slows its output frequency down from the maximum to 0 Hz.

Related function codes: F03, F08, E11, and H54

Digital input

Input signals given to the programmable input terminals or the programmable input terminals themselves. A command assigned to the digital input is called the terminal command to control the inverter externally.

Refer to Chapter 8, Section 8.4.1 "Terminal functions."

Electronic thermal overload protection

Electronic thermal overload protection to issue an early warning of the motor overheating to safeguard a motor.

An inverter calculates the motor overheat condition based on the internal data (given by function code P99 about the properties of the motor) and the driving conditions such as the drive current, voltage and frequency.

External potentiometer

A potentiometer (optional) that is used to set frequencies as well as built-in one.

Fan stop operation

A mode of control in which the cooling fan is shut down if the internal temperature in the inverter is low and when no operation command is issued.

Related function code: H06

Frequency accuracy (stability)

The percentage of variations in output frequency to a predefined maximum frequency.

Frequency limiter

Frequency limiter used inside the inverter to control the internal drive frequency in order to keep the motor speed within the specified level between the peak and bottom frequencies.

Related function codes: F15, F16, and H64

Frequency resolution

The minimum step, or increment, in which output frequency is varied, rather than continuously.

Function code

Code to customize the inverter. Setting function codes realizes the potential capability of the inverter to meet it for the individual power system applications.

Gain (for frequency setting)

A frequency setting gain enables varying the slope of the output of the frequency set with an analog input signal.

Related function codes: C32, C34, C37, and C39

IGBT (Insulated Gate Bipolar Transistor)

Stands for Insulated Gate Bipolar Transistor that enables the inverter section to switch high voltage/current DC power in very high speed and to output pulse train.

Interphase unbalance

A condition of an AC input voltage (supply voltage) that states the voltage balance of each phase in an expression as:

$$\begin{aligned} \text{Interphase voltage unbalance (\%)} \\ = \frac{\text{Max.voltage (V)} - \text{Min.voltage (V)}}{\text{3-phase average voltage (V)}} \times 67 \end{aligned}$$

Inverse mode operation

A mode of operation in which the output frequency lowers as the analog input signal level rises.

Jogging operation

A special operation mode of inverters, in which a motor jogs forward or reverse for a short time at a slower speed than usual operating modes.

Related function codes: F03, C20, and H54

Jump frequencies

Frequencies that have a certain output with no change in the output frequency within the specified frequency band in order to skip the resonance frequency band of a machine.

Related function codes: C01 to C04

Keypad operation

To use a keypad to run an inverter.

Line speed

Running speed of an object (e.g., conveyor) driven by the motor. The unit is meter per minute, m/min.

Load shaft speed

Number of revolutions per minute (r/min) of a rotating load driven by the motor, such as a fan.

Main circuit terminals

Power input/output terminals of an inverter, which includes terminals to connect the power source, motor, DC reactor, braking resistor, and other power components.

Maximum frequency

The output frequency commanded by the input of the maximum value of a frequency setup signal (for example, 10 V for a voltage input range of 0 to 10 V or 20 mA for a current input range of 4 to 20 mA).
Related function code: F03

Modbus RTU

Communication protocol used in global FA network market, which is developed by Modicon, Inc. USA.

Momentary voltage dip capability

The minimum voltage (V) and time (ms) that permit continued rotation of the motor after a momentary voltage drop (instantaneous power failure).

Multistep frequency selection

To preset frequencies (up to 7 stages), then select them at some later time using external signals.
Related function codes: E01 to E03, C05 to C11

Overload capability

The overload current that an inverter can tolerate, expressed as a percentage of the rated output current and also as a permissible energization time.

PID control

The scheme of control that brings controlled objects to a desired value quickly and accurately, and which consists of three categories of action: proportional, integral and derivative.

Proportional action minimizes errors from a set point. Integral action resets errors from a desired value to 0. Derivative action applies a control value in proportion to a differential component of the difference between the PID reference and feedback values. (See Chapter 4, Figure 4.7.)

Related function codes: E01 to E03, E40, E41, E43, E60 to E62, C51, C52, J01 to J06

Programming mode

One of the three operation modes supported by the inverter. This mode uses the menu-driven system and allows the user to set function codes or check the inverter status/maintenance information.

PTC (Positive Temperature Coefficient)

thermistor

Type of thermistor with a positive temperature coefficient. Used to safeguard a motor.

Related function codes: H26 and H27

Rated capacity

The rating of an inverter output capacity (at the secondary side), or the apparent power that is represented by the rated output voltage times the rated output current, which is calculated by solving the following equation and is stated in kVA:

$$\begin{aligned} \text{Rated capacity (kVA)} \\ &= \sqrt{3} \times \text{Rated output voltage (V)} \\ &\quad \times \text{Rated output current (A)} \times 10^{-3} \end{aligned}$$

The rated output voltage is assumed to be 230 V for 200 V class equipment and 460 V for 400 V class equipment.

Rated output current

A total RMS equivalent to the current that flows through the output terminal under the rated input and output conditions (the output voltage, current, frequency, and load factor meet their rated conditions). Essentially, equipment rated at 230 V covers the current of a 230 V, 60 Hz 6-pole motor and equipment rated at 460 V covers the current of a 380 V, 50 Hz 4-pole motor.

Rated output voltage

A fundamental wave RMS equivalent to the voltage that is generated across the output terminal when the AC input voltage (supply voltage) and frequency meet their rated conditions and the output frequency of the inverter equals the base frequency.

Required power supply capacity

The capacity required of a power supply for an inverter. This is calculated by solving either of the following equations and is stated in kVA:

$$\begin{aligned} \text{Required power supply capacity (kVA)} \\ &= \sqrt{3} \times 200 \times \text{Input RMS current (200V, 50Hz)} \\ &\text{or} \\ &= \sqrt{3} \times 220 \times \text{Input RMS current (220V, 60Hz)} \end{aligned}$$

Required power supply capacity (kVA)

$$\begin{aligned} &= \sqrt{3} \times 400 \times \text{Input RMS current (400V, 50Hz)} \\ &\text{or} \\ &= \sqrt{3} \times 440 \times \text{Input RMS current (440V, 60Hz)} \end{aligned}$$

Running mode

One of the three operation modes supported by the inverter. If the inverter is turned ON, it automatically enters this mode which you may: run/stop the motor, set up the set frequency, monitor the running status, and jog the motor.

S-curve acceleration/deceleration

(weak/strong)

To reduce the impact on the inverter driven machine during acceleration/deceleration, the inverter gradually accelerates/decelerates the motor at the both ends of the acceleration/deceleration zones like a figure of S letter.

Related function code: H07

Slip compensation control

A mode of control in which the output frequency of an inverter plus an amount of slip compensation is used as an actual output frequency to compensate for motor slippage.

Related function code: P09

Stall

A behavior of a motor when it loses speed by tripping of the inverter due to overcurrent detection or other malfunctions of the inverter.

Start frequency

The minimum frequency at which an inverter starts its output (not the frequency at which a motor starts rotating).

Related function code: F23

Starting torque

Torque that a motor produces when it starts rotating (or the drive torque with which the motor can run a load).

Simultaneous keying

To simultaneously press the 2 keys on the keypad. This presents the special function of inverters.

Stop frequency

The output frequency at which an inverter stops its output.

Related function code: F25

Thermal time constant

The time needed to activate the electronic thermal overload protection after the preset operation level (current) continuously flows. This is an adjustable function code data to meet the property of a motor that is not manufactured by Fuji Electric.

Related function code: F12

Torque boost

If a general-purpose motor is run with an inverter, voltage drops will have a pronounced effect in a low-frequency region, reducing the motor output torque. In a low-frequency range, therefore, to increase the motor output torque, it is necessary to augment the output voltage. This process of voltage compensation is called torque boost.

Related function code: F09

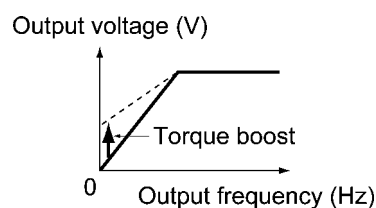

Transistor output

A control signal that generates predefined data from within an inverter via a transistor (open collector).

Trip

In response to an overvoltage, overcurrent, or any other unusual condition, actuation of an inverter's protective circuit to stop the inverter output.

V/f characteristic

A characteristic expression of the variations in output voltage V (V), and relative to variations in output frequency f (Hz). To achieve efficient motor operation, an appropriate V/f (voltage/frequency) characteristic helps a motor produce its output torque matching the torque characteristics of a load.

V/f control

The rotating speed N (r/min) of a motor can be stated in an expression as

$$N = \frac{120 \times f}{p} \times (1-s)$$

where,

f : Output frequency

p : Number of poles

s : Slippage

On the basis of this expression, varying the output frequency varies the speed of the motor. However, simply varying the output frequency f (Hz) would result in an overheated motor or would not allow the motor to demonstrate its optimum utility if the output voltage V (V) remains constant. For this reason, the output voltage V must be varied with the output frequency f by using an inverter. This scheme of control is called V/f control.

Variable torque load

A squared torque load is characterized by:

- 1) A change in the required torque in proportion to the square of the number of revolutions per minute.
- 2) A power requirement that decreases in proportion to the cube of the decrease in the number of revolutions per minute.

Required power (HP)

$$= \frac{\text{Rotating speed (r / min)} \times \text{Torque (N} \cdot \text{m)}}{9.55}$$

Related function code: F37

Applications: Fans and pumps

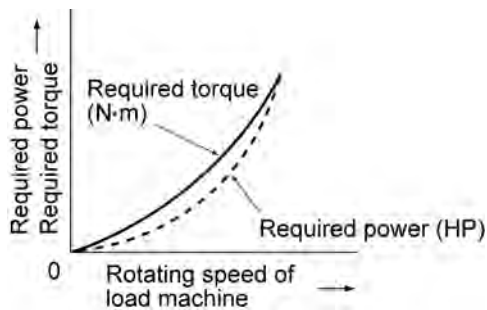

Voltage and frequency variations

Variations in the input voltage or frequency within permissible limits. Variations outside these limits might cause an inverter or motor to fail.

Compact Inverter
FRENIC-Mini

User's Manual

First Edition, July 2007

Fuji Electric FA Components & Systems Co., Ltd.

The purpose of this manual is to provide accurate information in the handling, setting up and operating of the FRENIC-Mini series of inverters. Please feel free to send your comments regarding any errors or omissions you may have found, or any suggestions you may have for generally improving the manual.

In no event will Fuji Electric FA Components & Systems Co., Ltd. be liable for any direct or indirect damages resulting from the application of the information in this manual.

