

where the world turns for couplings

Lovejoy[®]

S-Flex

SF

In This Section:

- J Type
- S Type
- B Type
- SC Type – Spacer
- T Type



where the world turns for couplings

Lovejoy[®]

S-Flex

SF

Safety Warning

When using Lovejoy products, you must follow these instructions and take the following precautions. Failure to do so may cause the power transmission product to break and parts to be thrown with sufficient force to cause severe injury or death.

Refer to this Lovejoy Catalog for proper selection, sizing, horsepower, torque range, and speed range of power transmission products, including elastomeric elements for couplings. Follow the installation instructions included with the product, and in the individual product catalogs for proper installation of power transmission products. Do not exceed catalog ratings.

During start up and operation of power transmission product, avoid sudden shock loads. Coupling assembly should operate quietly and smoothly. If coupling assembly vibrates or makes beating sound, shut down immediately, and recheck alignment. Shortly after initial operation and periodically thereafter, where applicable, inspect coupling assembly for: alignment, wear of elastomeric element, bolt torques, and flexing elements for signs of fatigue. Do not operate coupling assembly if alignment is improper, or where applicable, if elastomeric element is damaged, or worn to less than 75% of its original thickness.

Do not use any of these power transmission products for elevators, man lifts, or other devices that carry people. If the power transmission product fails, the lift device could fall resulting in severe injury or death.

For all power transmission products, you must install suitable guards in accordance with OSHA and American Society of Mechanical Engineers Standards. Do not start power transmission product before suitable guards are in place. Failure to properly guard these products may result in severe injury or death from personnel contacting moving parts or from parts being thrown from assembly in the event the power transmission product fails.

If you have any questions, contact the Lovejoy Engineering Department at 1-630-852-0500.

where the world turns for couplings

Lovejoy[®]

S-Flex

SF

Table of Contents

	Running Page No.	Section Page No.
Overview.....	74	SF-4
Elastomer Designs	75	SF-5
Selection Process.....	76	SF-6
Application Service Factors > Selection Data	77	SF-7
Performance Data	78	SF-8
S Type Inch Bore / Keyway > Item Selection.....	79	SF-9
Standard Sleeve, J and S Type Metric Bore / Keyway > Item Selection	80	SF-10
J, SC, SCF and SCHS Type > Item Selection	81	SF-11
Ratings > Performance Data	82	SF-12
Sleeves > Dimensional Data	83	SF-13
J Type > Dimensional Data.....	84	SF-14
S Type > Dimensional Data.....	85	SF-15
S Type Shallow Keyway > Dimensional Data.....	86	SF-16
B Type with Bushings > Dimensional Data.....	87	SF-17
T Type > Dimensional Data	88	SF-18
SC Type > Dimensional Data	89	SF-19
SC Type Flange > Dimensional Data	90	SF-20
SC Type Hub > Dimensional Data.....	91	SF-21

Elastomer In Shear Type Couplings

The simple design of the S-Flex coupling ensures ease of assembly and reliable performance. No special tools are needed for installation or removal. S-Flex couplings can be used in a wide variety of applications.

Features

- Easy to Install
- Maintenance Free
- No Lubrication
- Dampens Vibration and Controls Shock
- Torsionally Soft
- Double Engagement

Characteristics and Performance Facts

- The S-Flex coupling design is comprised of three parts: two flanges with internal teeth engage an elastomeric flexible sleeve with external teeth
- Torque is transmitted through the flanges mounted on both the driver and driven shafts via the sleeve
- Misalignment and torsional shock loads are absorbed by shear deflection in the sleeve
- The shear characteristic of the S-Flex coupling is very well suited to absorb impact loads
- The S-Flex coupling from Lovejoy offers combinations of flanges and sleeves which can be assembled to suit your specific application
- Thirteen sizes are available with torque capabilities that range from 60 in-lbs to 72,480 in-lbs
- The S-Flex flanges are offered in five models which are made from zinc or cast iron
- Sleeves are available in EPDM rubber, Neoprene, or Hytre[®] to address a wide variety of application requirements

Flange Types:

- J Type — Zinc Die Cast and Cast Iron, Bore Range ... 3/8 inch – 1-7/16 inch
- S Type — Cast Iron, Bore Range ... 1/2 inch – 5-1/2 inch
- B Type — Cast Iron with bushing
- SC Type — Cast Iron Spacer
- T Type — Cast Iron w/Taper-lock bushing

Hubs for SC Type Spacer Coupling:

- SCH Type — Powdered Metal or Cast Iron, Standard Length
- SCHS Type — Powdered Metal or Cast Iron, Short Length

Sleeve Types:

- JE – (EPDM) 1-piece solid
- JES – (EPDM) 1-piece split
- JN – (Neoprene) 1-piece solid
- JNS – (Neoprene) 1-piece split
- E – (EPDM) 2-piece with retaining ring
- N – (Neoprene) 2-piece with retaining ring
- H – (Hytre) 1-piece
- HS – (Hytre) 2-piece split

Protection from misalignment, shock, and vibration:

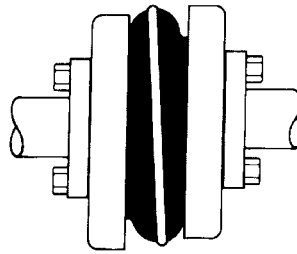

PARALLEL:

The S-Flex coupling accepts up to .062 in of parallel misalignment without wear. The flexible coupling sleeve minimizes the radial loads imposed on equipment bearings, a problem commonly associated with parallel misalignment.

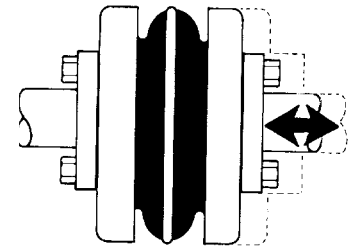

AXIAL:

The S-Flex couplings can be used in applications which require a limited amount of shaft end-float without transferring thrust loads to equipment bearings. Axial movement of approximately 1/8 inch accepted.

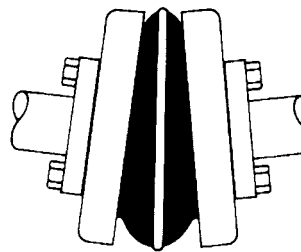

ANGULAR:

The flexing action of the elastomeric sleeve and the locking feature of the mating teeth allows the S-Flex coupling to effectively handle angular misalignment up to 1°.

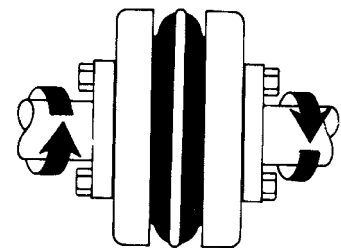

TORSIONAL:

S-Flex couplings effectively dampen torsional shock and vibration to protect connected equipment. The EPDM and Neoprene sleeves have torsional wind-up flexibility of 15° at their rated torque. Hytre provides 7° wind-up.



WARNING

You must refer to page SF-2 (Page 72) for Important Safety Instructions and Precautions for the selection and use of these products. Failure to follow the instructions and precautions can result in severe injury or death.

Elastomer Designs

- Lovejoy offers flexible sleeve for S-Flex coupling in three designs: one-piece solid, one-piece split, and two-piece with retaining ring
- The one-piece split design provides solutions for applications with unique requirements where small shaft separations inhibit the installation of a one-piece solid sleeve
- Pre-molded teeth along the diameter of the sleeve engage with teeth of the coupling flanges
- No clamps or screws are needed to connect the flanges with the flexible sleeve which securely lock together under torque for smooth transmission of power
- Torque is transmitted through shear loading of the sleeve
- All three sleeve materials are highly elastic which permits the S-Flex coupling to protect connected equipment from harmful shock loading, vibration, and shaft misalignment

JE, JN, JES, JNS Sleeve Types

These sleeves feature a one-piece design molded in EPDM & Neoprene rubber. In the case of JES & JNS Types, the one-piece design is split to provide for ease of installation and removal.

E, N Sleeve Types

These sleeves feature a two-piece design with retaining ring. The E Type is molded in EPDM rubber and the N Type is molded in Neoprene. The two-piece design is ideal for applications where there is difficulty in separating the shafts of the driver and driven.

H, HS Sleeve Types

These sleeves feature both a one-piece solid (H) and two-piece split (HS) design and are molded of Hytrel. The sleeves in Hytrel material are designed to transmit power for high torque applications. Because of the design and the properties of the Hytrel molded sleeve, the H and HS sleeves should not be used as direct replacements for EPDM or Neoprene sleeves, and can only be used with S, TF, or SC flanges.

Sleeve Materials

EPDM – Unless otherwise specified, S-Flex couplings are supplied with EPDM flexible sleeves. EPDM has good resistance to commonly used chemicals and is generally not affected by dirt or moisture. Color is black.

NEOPRENE – Neoprene provides very good performance characteristics for most applications and offers a very good resistance to chemical and oil conditions. Color is black with a green dot.

HYTREL® – Hytrel is a polyester elastomer designed for high torque and high temperature applications and offers excellent resistance to chemical and oil conditions. Color is orange.



JE and JN Type



JES and JNS Type



E and N Type

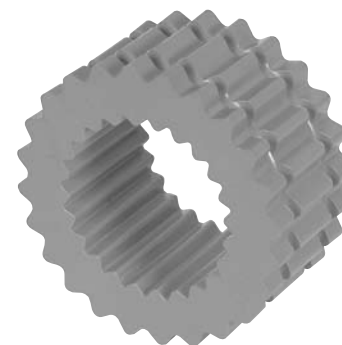

H Type

Notes: ■ See page ED-9 for sleeve chemical resistance chart.
 ■ Hytrel is a registered trademarks of E.I. DuPont Nemours & Co.



S-Flex Coupling Selection Process

The selection process for determining the proper S-Flex coupling requires using the charts shown on the following pages. There are three components to be selected, two flanges and one sleeve.

Information necessary before a coupling can be selected:

- HP and RPM of Driver or running torque
- Shaft size of Driver and Driven equipment and corresponding keyways
- Application or equipment description
- Environmental conditions (i.e. extreme temperature, corrosive conditions, space limitations)

List of Charts provided for Selection:

- Chart 1 - Application Service Factors (page SF-7)
- Chart 2 - Sleeve Performance Data (page SF-8)
- Chart 3 - S-Flex Nominal Rated Torque Data (page SF-8)

Formulas:

$$\text{Nominal Torque} = \frac{\text{in-lb} \times (\frac{\text{HP} \times 63025}{\text{RPM}})}{\text{Nm} = \frac{(\frac{\text{KW} \times 9550}{\text{RPM}})}$$

Design Torque = Nominal Torque x Application Service Factor

SF

Steps In Selecting An S-Flex Coupling

Step 1: Determine the Nominal Torque in in-lb of your application by using the following formula:

$$\text{Nominal Torque} = \frac{(\text{HP} \times 63025)}{\text{RPM}}$$

Step 2: Using the Application Service Factor Chart 1 (page SF-7) select the service factor which best corresponds to your application.

Step 3: Calculate the Design Torque of your application by multiplying the Nominal Torque calculated in Step 1 by the Application Service Factor determined in Step 2.

$$\text{Design Torque} = \text{Nominal Torque} \times \text{Application Service Factor}$$

Step 4: Using the Sleeve Performance Data Chart 2 (page SF-8) select the sleeve material which best corresponds to your application.

Step 5: Using the S-Flex Nominal Rated Torque Chart 3 (page SF-8) locate the appropriate sleeve material column for the sleeve selected in Step 4.

Step 6: Scan down this column to the first entry where the Torque Value in the column is greater than or equal to the Design Torque calculated in Step 3.

Refer to the maximum RPM value of the coupling size to ensure that the application requirements are met. If the maximum RPM value is less than the application requirement, S-Flex couplings are not recommended for the application.

Note: ■ If Nominal Torque is less than 1/4 of the coupling's nominal rated torque, misalignment capacities are reduced by 1/2. Once torque value is located, refer to the corresponding coupling size in the first column of the S-Flex Nominal Rated Torque Data Chart 3 (page SF-8).

Step 7: Compare the application driver/driven shaft sizes to the maximum bore size available on the coupling selected. If coupling max bore is not large enough for the shaft diameter, select the next largest coupling that will accommodate the driver/driven shaft diameters.

Step 8: Using the Item Selection tables, find the appropriate Keyway and Bore size required and locate the Lovejoy UPC number.



S-Flex

Application Service Factors

Selection Data

Application Service Factors

Chart 1

	Service Factors				Service Factors				Service Factors		
	Electric Motor w/ Standard Torque	Electric Motor w/ High Torque	Turbines, Air & Hydraulic Motors		Electric Motor w/ Standard Torque	Electric Motor w/ High Torque	Turbines, Air & Hydraulic Motors		Electric Motor w/ Standard Torque	Electric Motor w/ High Torque	Turbines, Air & Hydraulic Motors
Agitators	1.25	1.50	1.00	Disc Feeder	1.25	1.50	1.00	Pressers			
Band Resaw (lumber).....	1.50	2.00	1.25	Dough Mixer	1.50	2.00	1.25	Brick, Briquette Machine.....	2.00	2.50	1.50
Barge Haul Puller	2.00	2.50	1.50	Draw Bench Conveyor & Main Drive	2.00	2.50	1.50	Notching, Paper, Punch			
Barking (lumber).....	2.00	2.50	1.50	Dredges				Printing.....	1.50	2.00	1.25
Bar Screen (sewage).....	2.00	2.50	1.50	Cable reef, Pumps.....	1.50	2.00	1.25	Pug Mill	1.50	2.00	1.25
Batches (textile).....	1.25	1.50	1.00	Cutter head, Jig, & Screen Drives.....	2.00	2.50	1.50	Pulp Grinder (paper).....	2.00	2.50	1.50
Beater and Pulper (paper).....	1.50	2.00	1.25	Maneuvering & Utility Winch, Stackers.....	1.50	2.00	1.25	Pulverizers			
Bending Roll (metal).....	1.50	2.00	1.25	Dynamometer	1.25	1.50	1.00	Hammermill—Light Duty, Roller.....	1.50	2.50	1.25
Bleacher (paper).....	1.25	1.50	1.00	Dryers (rotary).....	1.50	2.00	1.25	Hammermill—Heavy Duty Hog.....	2.00	2.50	1.50
Blowers				Edger (lumber).....	2.00	2.50	1.50	Pumps			
Centrifugal, Vane.....	1.25	1.50	1.00	Escalators ¹	1.25	1.50	1.00	Centrifugal, Axial.....	1.25	1.50	1.00
Lobe.....	1.50	2.00	1.25	Extruders (metal).....	2.00	2.50	1.50	Gear, Lobe, Vane.....	1.50	2.00	1.25
Bottling Machinery	1.25	1.50	1.00	Fans				Reciprocating—Sgl. or Dbl. Acting Cylinder.....	2.00	2.50	2.00
Brew Kettles (distilling).....	1.25	1.50	1.00	Centrifugal.....	1.25	1.50	1.00	Reel, Rewinder (paper)			
Bucket Elevator or Conveyor	1.50	2.00	1.25	Cooling Towers.....	2.00	2.50	1.50	Cable.....	1.50	2.00	1.25
Calenders				Forced Draft, Large Industrial.....	1.50	2.00	1.25	Rod Mill	2.00	2.50	1.50
Calender (paper).....	1.50	2.00	1.25	Feeders				Saw Dust Conveyor	1.25	1.50	1.00
Calender (rubber), Calender-super (paper).....	2.00	2.50	1.50	Apron, Belt, Disc.....	1.25	1.50	1.00	Screens			
Cane Knives (sugar).....	1.50	2.00	1.25	Reciprocating.....	2.00	2.50	1.50	Air Washing, Water.....	1.25	1.50	1.00
Card Machine (textile).....	2.00	2.50	1.50	Screw.....	1.50	2.00	1.25	Rotary—Coal or Sand.....	1.50	2.00	1.25
Car Dumpers	2.00	2.50	1.50	Filter, Press-Oil	1.50	2.00	1.25	Vibrating.....	2.00	2.50	2.00
Car Pullers	1.50	2.00	1.25	Generators				Screw Conveyor	1.25	1.50	1.00
Cement Kiln	2.00	2.50	1.50	Uniform Load.....	1.25	1.50	1.00	Slab Conveyor (lumber).....	1.50	2.00	1.25
Centrifugal, Blower, Fans, Compressors, or Pumps	1.25	1.50	1.00	Varying Load, Hoist.....	1.50	2.00	1.25	Slitters (metal).....	1.50	2.00	1.25
Chemical Feeders (sewage).....	1.25	1.50	1.00	Welders.....	2.00	2.50	1.50	Soapers (textile).....	1.25	1.50	1.00
Chiller (oil).....	1.50	2.00	1.25	Grit Collector (sewage).....	1.25	1.50	1.00	Sorting Table (lumber).....	1.50	2.00	1.25
Chipper (paper).....	2.00	2.50	1.50	Grizzly	2.00	2.50	1.50	Spinner (textile).....	1.50	2.00	1.25
Circular Resaw (lumber).....	1.50	2.00	1.25	Hammermills				Stoker	1.25	1.50	1.00
Clarifier or Classifier	1.25	1.50	1.00	Light Duty, Intermittent.....	1.50	2.00	1.25	Suction Roll (paper).....	1.50	2.00	1.25
Clay Working Machinery	1.50	2.00	1.25	Heavy Duty, Continuous.....	2.00	2.50	1.50	Tenter Frames (textile).....	1.50	2.00	1.25
Collectors (sewage).....	1.25	1.50	1.00	Hoists				Tire Building Machines	2.00	2.50	1.50
Compressors				Heavy Duty.....	2.00	2.50	1.50	Tire & Tube Press Opener	1.25	1.50	1.00
Centrifugal, Screw, Lobe.....	1.25	1.50	1.00	Medium Duty.....	1.50	2.00	1.25	Tumbling Barrels	2.00	2.50	1.50
Reciprocating.....	See Note			Jordan (paper).....	2.00	2.50	1.50	Washer & Thickener (paper).....	1.50	2.00	1.25
Concrete Mixers	1.50	2.00	1.25	Kiln, Rotary Laundry Washer or Tumbler	2.00	2.50	1.50	Winches	1.50	2.00	1.25
Converting Machine (paper).....	1.50	2.00	1.25	Line Shafts	1.25	1.50	1.00	Winders—Paper, Textile, Wire	1.50	2.00	1.25
Conveyors				Log Hall (lumber).....	2.00	2.50	1.50	Windlass	1.50	2.00	1.25
Apron, Assembly, Belt, Flight, Oven, Screw.....	1.25	1.50	1.00	Loom (textile).....	1.50	2.00	1.25	Wire			
Bucket.....	1.50	2.00	1.25	Machine Tools, Main Drives	1.50	2.00	1.25	Drawing.....	2.00	2.50	1.50
Cookers—Brewing, Distilling, Food	1.25	1.50	1.00	Mangle (textile).....	1.25	1.50	1.00	Winding.....	1.50	2.00	1.25
Cooling Tower Fans	2.00	2.50	1.50	Mash Tubs (distilling).....	1.25	1.50	1.00	Woodworking Machinery	1.25	1.50	1.00
Couch (paper).....	1.50	2.00	1.25	Meat Grinder	1.50	2.00	1.25				
Cranes & Hoists ¹				Metal Forming Machines	1.50	2.00	1.25				
Heavy duty mine.....	2.00	2.50	1.50	Mills							
Crushers—Cane (sugar), Stone, Ore.....	2.00	2.50	1.50	Ball, Pebble, Rod, Tube, Rubber, Tumbling.....	2.00	2.50	1.50				
Cutter-Paper	2.00	2.50	1.50	Dryers, Coolers.....	1.50	2.00	1.25				
Cylinder (paper).....	2.00	2.50	1.50	Mixers							
Dewatering Screen (sewage).....	1.50	2.00	1.25	Concrete, Muller.....	1.50	2.00	1.25				
				Banbury.....	2.00	2.50	1.50				
				Ore Crusher	2.00	2.50	1.50				
				Oven Conveyor	1.25	1.50	1.00				
				Planer (metal or wood).....	1.50	2.00	1.25				

SF

Caution: Applications involving reciprocating engines and reciprocating driven devices are subject to critical rotational speeds which may damage the coupling and/or connected equipment. Contact Lovejoy Engineering with specific requirements.

Note: ■ 1 indicates: If people are transported, Lovejoy does not recommend and will not warranty the use of the coupling.



Sleeve Performance Data

Chart 2

Characteristics	Temperature Range		Misalignment Capabilities			Torsional Wind-Up
	F°	C°	Angular (in)	Parallel (in)	Axial (in)	in
EDPM – Unless otherwise specified, S-Flex couplings are supplied with EPDM flexible sleeves. EPDM has good resistance to commonly used chemicals and is generally not affected by dirt or moisture. Color is black.	-30° to 375° F	-34° to 135° C	1°	up to .062	.125	up to 15°
NEOPRENE – Neoprene provides very good performance characteristics for most applications and offers a very good resistance to chemical and oil conditions. Color is black with a green dot.	0° to 200° F	-18° to 93° C	1°	up to .062	.125	up to 15°
HYTREL® – Hytrel is a polyester elastomer designed for high torque and high temperature applications and offers excellent resistance to chemical and oil conditions. Color is orange.	-65° to 250° F	-54° to 121° C	.25°	up to .035	.125	up to 7°

SF

S-Flex Nominal Rated Torque Data

Chart 3

Size	ID1 - ID2		EPDM			Neoprene			Hytrel ¹		
	Min Bore	Max Bore	Torque		Max	Torque		Max	Torque		Max
	in	in	in-lb	Nm	RPM	in-lb	Nm	RPM	in-lb	Nm	RPM
3	0.375	0.875	60	6.78	9,200	60	6.78	9,200	N/A	N/A	N/A
4	0.500	1.000	120	13.56	7,600	120	13.56	7,600	N/A	N/A	N/A
5	0.500	1.188	240	27.12	7,600	240	27.12	7,600	N/A	N/A	N/A
6	0.625	1.438	450	50.84	6,000	450	50.84	6,000	1,800	203.37	6,000
7	0.625	1.625	725	81.91	5,250	725	81.91	5,250	2,875	324.83	5,250
8	0.750	1.938	1,135	128.24	4,500	1,135	128.24	4,500	4,530	511.82	4,500
9	0.875	2.375	1,800	203.37	3,750	1,800	203.37	3,750	7,200	813.49	3,750
10	1.125	2.750	2,875	324.83	3,600	2,875	324.83	3,600	11,350	1 282.38	3,600
11	1.250	3.375	4,530	511.82	3,600	4,530	511.82	3,600	18,000	2 033.73	3,600
12	1.500	3.875	7,200	813.49	2,800	7,200	813.49	2,800	31,500	3 559.03	2,800
13	2.000	4.500	11,350	1 282.38	2,400	11,350	1 282.38	2,400	47,268	5 340.57	2,400
14	2.000	5.000	18,000	2 033.73	2,200	18,000	2 033.73	2,200	72,480	8 189.15	2,200
16	2.000	5.500	47,250	5 338.54	1,500	N/A	N/A	N/A	N/A	N/A	N/A

Note: ■ 1 indicates: Operating Hytrel within a high service factor application is not recommended.



S-Flex

S Type Inch Bore / Keyway

Item Selection

The S Type coupling consists of two flanges and one sleeve.

S Type Flange - Inch Bore and Keyway UPC Number Selection Table

Bore	Keyway	5S	6S	7S	8S	9S	10S	11S	12S	13S	14S	16S
1/2	No Keyway	36349	—	—	—	—	—	—	—	—	—	—
1/2	7/8 x 1/16	36067	—	—	—	—	—	—	—	—	—	—
5/8	No Keyway	—	36353	36355	—	—	—	—	—	—	—	—
5/8	3/16 x 3/32	36068	36093	36116	—	—	—	—	—	—	—	—
3/4	No Keyway	—	—	—	36357	—	—	—	—	—	—	—
3/4	3/16 x 3/32	36069	36094	36117	36132	—	—	—	—	—	—	—
13/16	3/16 x 3/32	36070	—	—	—	—	—	—	—	—	—	—
7/8	No Keyway	—	—	—	—	36359	—	—	—	—	—	—
7/8	3/16 x 3/32	36071	36095	36118	36133	36151	—	—	—	—	—	—
15/16	1/4 x 1/8	36072	36096	36119	36134	44363	—	—	—	—	—	—
1	1/4 x 1/8	36073	36097	36120	36135	36152	—	—	—	—	—	—
1-1/16	1/4 x 1/8	36074	36098	36121	44364	45742	46612	—	—	—	—	—
1-1/8	No Keyway	—	—	—	—	—	36361	—	—	—	—	—
1-1/8	1/4 x 1/8	36075	36099	36122	36136	36153	36363	—	—	—	—	—
1-3/16	1/4 x 1/8	36076	36100	36123	36137	—	46613	—	—	—	—	—
1-1/4	No Keyway	—	—	—	—	—	—	36365	—	—	—	—
1-1/4	1/4 x 1/16	36077	—	—	—	—	—	—	—	—	—	—
1-1/4	1/4 x 1/8	—	36101	36124	36138	36154	36171	36189	—	—	—	—
1-5/16	5/16 x 5/32	—	36102	36125	36139	—	—	—	—	—	—	—
1-3/8	5/16 x 5/32	—	36103	36126	36140	36155	36172	36190	—	—	—	—
1-7/16	3/8 x 3/16	—	36104	36127	36141	36156	36173	—	—	—	—	—
1-1/2	No Keyway	—	—	—	—	—	—	—	36367	—	—	—
1-1/2	3/8 x 1/8	—	36105	—	—	—	—	—	—	—	—	—
1-1/2	3/8 x 3/16	—	—	36128	36142	36157	36174	36191	36200	—	—	—
1-9/16	3/8 x 3/16	—	—	—	—	36158	36980	55291	—	—	—	—
1-5/8	3/8 x 3/16	—	36106	—	—	—	—	—	—	—	—	—
1-5/8	3/8 x 3/16	—	—	36129	36143	36159	36175	36192	55059	—	—	—
1-11/16	3/8 x 3/16	—	—	—	36144	36160	36176	49451	—	—	—	—
1-3/4	3/8 x 1/8	—	36107	36130	—	—	—	—	—	—	—	—
1-3/4	3/8 x 3/16	—	—	—	36145	36161	36177	36193	41773	—	—	—
1-7/8	1/2 x 1/8	—	—	36131	—	—	—	—	—	—	—	—
1-7/8	1/2 x 1/4	—	—	—	36146	36162	36178	36194	36201	—	—	—
1-15/16	1/2 x 1/4	—	—	—	36147	36163	36179	49816	56796	—	—	—
2 RSB	No Keyway	—	—	—	—	—	—	—	—	35441	35445	35448
2	1/2 x 1/4	—	—	—	—	36164	36180	45158	45672	—	—	—
2	1/2 x 3/16	—	—	—	36148	—	—	—	—	—	—	—
2-1/8	1/2 x 3/16	—	—	—	36149	—	—	—	—	—	—	—
2-1/8	1/2 x 1/4	—	—	—	—	36165	36181	36195	36202	55060	55062	—
2-3/16	1/2 x 1/4	—	—	—	—	36166	36182	—	—	—	—	—
2-1/4	1/2 x 1/4	—	—	—	—	36167	36183	45544	55560	—	—	—
2-3/8	5/8 x 1/8	—	—	—	36150	—	—	—	—	—	—	—
2-3/8	5/8 x 5/16	—	—	—	—	36168	36184	36196	36203	35442	55063	—
2-7/16	5/8 x 5/16	—	—	—	—	—	36185	55229	56808	—	—	—
2-1/2	5/8 x 5/16	—	—	—	—	36169	—	—	—	—	—	—
2-1/2	5/8 x 5/16	—	—	—	—	—	36186	56581	47895	—	—	—
2-3/4	5/8 x 5/16	—	—	—	—	46349	46585	45543	54940	—	—	—
2-7/8	3/4 x 1/8	—	—	—	—	36170	36187	—	—	—	—	—
2-7/8	3/4 x 3/8	—	—	—	—	—	—	36197	36204	35443	35446	—
3-3/8	7/8 x 3/16	—	—	—	—	—	36188	—	—	—	—	—
3-3/8	7/8 x 7/16	—	—	—	—	—	—	36198	36205	55061	55064	—
3-7/8	1 x 1/4	—	—	—	—	—	—	36199	—	—	—	—
3-7/8	1 x 1/2	—	—	—	—	—	—	—	36206	—	—	—

Notes: ■ All standard finished bore keyway flanges have 2 set screws @ 90°. Sizes 13,14 and 16 RSB flanges are suitable for reboring and have two set screws @ 90°. Sizes 5-12 RSB flanges have no set screws.
 ■ When referencing the Lovejoy UPC number in this table, include 685144 as a prefix to the number shown.



S-Flex

Standard Sleeve, J and S Type Metric Bore / Keyway Item Selection

The J and S Type coupling consists of two flanges and one sleeve.

S-Flex Standard Sleeve UPC Number Selection Table

Size	JE	Bulk Pack JE ¹	JES	Bulk Pack JES ¹	JN	JNS	E	Bulk Pack E ¹	N	H	HS
3	36384	52712	36692	52713	35356	36866	—	—	—	—	—
4	35359	52714	36695	52715	35360	36869	—	—	—	—	—
5	35350	52716	36698	52717	35366	36872	35368	52718	35369	—	—
6	35569	52719	36701	52720	35394	36875	35600	52721	36411	40738	40741
7	35570	52722	36707	52723	36398	36878	36414	52724	36416	36848	41704
8	35572	52725	36864	52726	36402	36881	36419	52727	36421	36514	40072
9	36405	—	35451	—	—	—	36424	—	36426	40744	40747
10	35450	—	—	—	—	—	36429	—	35453	35454	35455
11	—	—	—	—	—	—	36433	—	35457	35458	35459
12	—	—	—	—	—	—	36437	—	35461	35462	35463
13	—	—	—	—	—	—	35464	—	35465	—	35466
14	—	—	—	—	—	—	35467	—	35468	—	35469
16	—	—	—	—	—	—	35470	—	—	—	—

Note: ■ 1 indicates: Bulk pack sizes 3-6 contain ten pieces, sizes 7-8 contain five pieces.

J and S Type - Metric Bore and Keyway UPC Number Selection Table

Bore	Keyway	3J	4J	5S	6S	7S	8S	9S	10S	11S	12S
9	No Keyway	41485	—	—	—	—	—	—	—	—	—
11	4 x 1.8	41486	—	—	—	—	—	—	—	—	—
12	No Keyway	—	41499	—	—	—	—	—	—	—	—
12	4 x 1.8	41487	—	—	—	—	—	—	—	—	—
14	No Keyway	—	—	41514	—	—	—	—	—	—	—
14	5 x 2.3	41488	41500	41515	—	—	—	—	—	—	—
15	No Keyway	—	—	—	41531	—	—	—	—	—	—
15	5 x 2.3	41489	41501	—	—	—	—	—	—	—	—
16	5 x 2.3	41490	41502	41516	—	—	—	—	—	—	—
19	No Keyway	—	—	—	—	41547	—	—	—	—	—
19	6 x 2.8	41491	41503	41517	41532	56571	—	—	—	—	—
20	6 x 2.8	—	41504	41518	41533	—	—	—	—	—	—
24	No Keyway	—	—	—	—	—	41561	41575	—	—	—
24	8 x 3.3	—	41505	41519	41534	51257	55746	—	—	—	—
25	8 x 3.3	—	—	41520	41535	41548	—	—	—	—	—
28	8 x 3.3	—	—	41521	41536	41549	41562	—	—	—	—
30	8 x 3.3	—	—	—	41537	41550	41563	41576	52258	—	—
32	10 x 3.3	—	—	—	41538	41551	41564	41577	59839	—	—
35	10 x 3.3	—	—	—	41539	49552	—	—	59721	—	—
38	10 x 3.3	—	—	—	55323	41552	41565	41578	45222	59889	—
42	12 x 3.3	—	—	—	—	41553	41566	41579	45883	59888	—
45	14 x 3.8	—	—	—	—	—	41567	46034	48389	—	—
48	14 x 3.8	—	—	—	—	—	41568	41580	59838	59887	—
50	14 x 3.8	—	—	—	—	—	—	—	44380	—	59855
52	16 x 4.3	—	—	—	—	—	—	—	58450	59720	—
55	16 x 4.3	—	—	—	—	—	—	—	45956	64136	—
60	18 x 4.4	—	—	—	—	—	—	—	52009	52711	54955
65	18 x 4.4	—	—	—	—	—	—	—	—	—	54941
70	20 x 4.9	—	—	—	—	—	—	—	—	59886	58725
80	22 x 5.4	—	—	—	—	—	—	—	—	59885	59856
90	25 x 5.4	—	—	—	—	—	—	—	—	—	59857

Notes: ■ Metric Bore / Keyway per DIN specifications. See engineering section for tolerances (page ED-17 and ED-19).
 ■ When referencing the Lovejoy UPC number in this table, include 685144 as a prefix to the number shown.

The J Type coupling consists of two J flanges and one sleeve.

J Type Flange - Inch Bore and Keyway UPC Number Selection Table

Bore	Keyway	3J	4J	5J	6J
3/8	No Keyway	36046	—	—	—
1/2	No Keyway	36114	36115	36347	—
1/2	1/8 x 1/16	36047	36051	36057	—
5/8	No Keyway	—	—	—	36351
5/8	3/16 x 3/32	36048	36052	36058	36078
3/4	3/16 x 3/32	36049	36053	36059	36079
7/8	3/16 x 3/32	36050	36054	36060	36080
15/16	1/4 x 1/8	—	36055	36061	36081
1	1/4 x 1/8	—	36056	36062	36082
1-1/16	1/4 x 1/8	—	—	36063	36083
1-1/8	1/4 x 1/8	—	—	36064	36084
1-3/16	1/4 x 1/8	—	—	—	36085
1-1/4	1/4 x 1/8	—	—	—	36086
1-5/16	5/16 x 5/32	—	—	—	36087
1-3/8	5/16 x 5/32	—	—	—	36088

Notes:

- We do not recommend reboring 3J or 4J Flanges.
- See page ED-8 for standard keyway dimensions.



J Type

SF

The SC Type coupling consists of two SCH or SCHS hubs, two SC spacer flanges, and one sleeve.

SC Type Spacer Flanges

For Required Shaft Separation ¹	SC Flange Size	Coupling Size														
		5	6	7	8	8-10	9	9-11	10	10-13	11	11-14	12	12-14	13	14
3-1/2	35	36524	36526	36532	36538	36540	36548	—	—	—	—	—	—	—	—	—
4-3/8	44	—	36528	36534	36542	—	36550	—	—	—	—	—	—	—	—	—
4-3/4	48	—	—	—	—	—	—	—	36560	—	36570	—	—	—	—	—
5	50	—	36530	36536	36544	36546	36552	36554	36562	—	36572	—	—	—	—	—
7	70	—	—	—	—	—	—	36556	—	36564	—	36574	36580	38582	—	—
7-3/4	78	—	—	—	—	—	—	36558	—	36566	—	36576	36584	36586	54200	54202
10	100	—	—	—	—	—	—	—	—	36568	—	36578	—	36588	—	—

Note: ■ 1 indicates: See page SF-22 for other lengths possible thru various combinations.

SCH and SCHS Type - Inch Bore and Keyway UPC Number Selection Table

Bore	Keyway	5SCH	6SCH	7SCH	8SCH	9SCH	9SCHS	10SCH	10SCHS	11SCH	11SCHS	12SCH	12SCHS	13SCH	13SCHS	14SCH
1/2	No Keyway	36710	—	—	—	—	—	—	—	—	—	—	—	—	—	—
1/2	1/8 x 1/16	36711	—	—	—	—	—	—	—	—	—	—	—	—	—	—
5/8	No Keyway	—	36712	—	36714	—	—	—	—	—	—	—	—	—	—	—
5/8	3/16 x 3/32	36590	36713	36715	—	—	—	—	—	—	—	—	—	—	—	—
3/4	No Keyway	—	—	—	36718	—	—	—	—	—	—	—	—	—	—	—
3/4	3/16 x 3/32	36591	36600	36716	36719	—	—	—	—	—	—	—	—	—	—	—
7/8	No Keyway	—	—	—	—	36721	36910	—	—	—	—	—	—	—	—	—
7/8	3/16 x 3/32	36592	36601	36612	36624	36722	—	—	—	—	—	—	—	—	—	—
1	1/4 x 1/8	36593	36602	36613	36625	36640	—	—	—	—	—	—	—	—	—	—
1-1/8	No Keyway	—	—	—	—	—	—	36729	36912	36737	36914	—	—	—	—	—
1-1/8	1/4 x 1/8	36594	36603	36614	36626	36641	36682	36728	36684	36738	36686	—	—	—	—	—
1-1/4	1/4 x 1/8	—	36604	36717	36720	36723	36725	59905	36733	—	36741	—	—	—	—	—
1-3/8	5/16 x 5/32	—	36605	36615	36627	36642	36726	56486	36734	—	36742	—	—	—	—	—
1-1/2	3/8 x 3/16	—	—	36616	36628	36643	36727	59906	36735	59908	36743	—	—	—	—	—
1-5/8	3/8 x 3/16	—	—	36617	36629	36644	—	36656	36736	54909	36687	—	—	—	—	—
1-3/4	3/8 x 3/16	—	—	—	36630	36645	—	36730	—	59909	—	—	—	—	—	—
1-7/8	1/2 x 1/4	—	—	—	36631	36646	—	36657	—	36664	—	36745	36747	—	—	—
2	1/2 x 1/4	—	—	—	—	36724	—	36731	—	36739	—	—	36748	—	—	—
2-1/8	1/2 x 1/4	—	—	—	—	36647	—	36658	—	36665	—	36672	36749	—	36756	—
2-1/4	1/2 x 1/4	—	—	—	—	—	—	36732	—	36740	—	36746	36750	—	—	—
2-3/8	5/8 x 5/16	—	—	—	—	—	—	36659	—	36666	—	36673	—	36752	36757	36759
2-7/8	3/4 x 3/8	—	—	—	—	—	—	—	—	36667	—	36674	—	36753	—	36760
3-3/8	7/8 x 7/16	—	—	—	—	—	—	—	—	—	—	—	—	36754	—	36761
3-7/8	1 x 1/2	—	—	—	—	—	—	—	—	—	—	—	—	—	—	36762

Note: ■ When referencing the Lovejoy UPC number in this table, include 685144 as a prefix to the number shown.



S-Flex Ratings Performance Data

S-Flex Performance Ratings

Size	Sleeve Material	Basic HP Ratings @ Varying RPM				Torque Rating		Torsional ¹ Stiffness in-lb/rad	Max Bore		Max RPM
		100	1200	1800	3600	in-lbs	Nm		in	mm	
3	EPDM & Neoprene	0.1	1.1	1.7	3.4	60	6.78	229	0.875	22	9,200
4	EPDM & Neoprene	0.2	2.3	3.4	6.9	120	13.56	458	1.000	25	7,600
5	EPDM & Neoprene	0.4	4.6	6.9	13.7	240	27.12	916	1.188	30	7,600
6	EPDM & Neoprene	0.7	8.6	12.9	25.7	450	50.84	1,718	1.438	38	6,000
6H	Hytrel®	2.9	34.0	51.0	103.0	1,800	203.37	10,000	1.438	38	6,000
7	EPDM & Neoprene	1.2	14.0	21.0	41.0	725	81.91	2,769	1.625	42	5,250
7H	Hytrel	4.6	55.0	82.0	164.0	2,875	324.83	20,000	1.625	42	5,250
8	EPDM & Neoprene	1.8	22.0	32.0	65.0	1,135	128.24	4,335	1.938	49	4,500
8H	Hytrel	7.2	86.0	129.0	259.0	4,530	511.82	30,000	1.938	49	4,500
9	EPDM & Neoprene	2.9	34.0	51.0	103.0	1,800	203.37	6,875	2.375	60	3,750
9H	Hytrel	11.4	137.0	206.0	411.0	7,200	813.49	47,500	2.375	60	3,750
10	EPDM & Neoprene	4.6	55.0	82.0	164.0	2,875	324.83	10,980	2.750	70	3,600
10H	Hytrel	18.0	216.0	324.0	648.0	11,350	1 282.38	100,000	2.750	70	3,600
11	EPDM & Neoprene	7.2	86.0	129.0	259.0	4,530	511.82	17,300	3.375	86	3,600
11H	Hytrel	28.6	343.0	514.0	1,028.0	18,000	2 033.73	12,500	3.375	86	3,600
12	EPDM & Neoprene	11.4	137.0	206.0	—	7,200	813.49	27,500	3.875	99	2,800
12H	Hytrel	50.0	600.0	900.0	—	31,500	3 559.03	225,000	3.875	99	2,800
13	EPDM & Neoprene	18.0	216.0	324.0	—	11,350	1 282.38	43,350	4.500	114	2,400
13H	Hytrel	75.0	900.0	1,350.0	—	47,268	5 340.57	368,900	4.500	114	2,400
14	EPDM & Neoprene	28.6	343.0	514.0	—	18,000	2 033.73	68,755	5.000	127	2,200
14H	Hytrel	115.0	1,380.0	2,070.0	—	72,480	8 189.15	593,250	5.000	127	2,200
16	EPDM	75.0	900.0	—	—	47,250	5 338.54	180,480	5.500	140	1,500

Notes: ■ 1 indicates: Values shown are for an ambient temperature of 75° F (24° C).
 ■ Coupling ratings are based on sleeve material regardless of flange design.

S-Flex Sleeve Types

S-Flex Sleeves

- Flexible sleeves for Lovejoy S-Flex couplings are available in three materials (EPDM, Neoprene, and Hytrel®) and in three basic designs: one piece solid, one-piece split, or two piece

JE, JN, JES and JNS Types

- JE and JN Type sleeves feature a one-piece solid design
- JES and JNS Type sleeves feature a one-piece split design
- JE and JES Type sleeves are molded in EPDM material
- JN and JNS Type sleeves are molded in Neoprene material

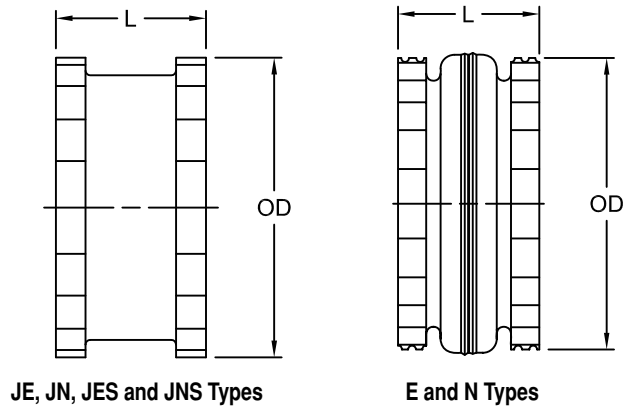

E and N Types

- E and N Type sleeves feature a two-piece design with retaining ring
- E Type sleeves are made from EPDM material and are available in sizes 5-16
- N Type sleeves are made from Neoprene material and are available in sizes 5-14
- Two piece sleeves are ideal for applications where small shaft separations inhibit the installation of a one piece sleeve

H and HS Types

- H and HS Type sleeves are designed for high torque applications, transmitting about 4 times as much power as an equivalent EPDM or Neoprene sleeve
- Hytrel sleeves are available in a one-piece solid (H) or two-piece split (HS) construction
- Hytrel sleeves can be used only with S or SC flanges and can not be used with J or B flanges
- Hytrel sleeves should not be used as direct replacements for EPDM or Neoprene applications
- H and HS Type sleeves are available for sizes 6-14 (sizes 13 and 14 are available in HS only)

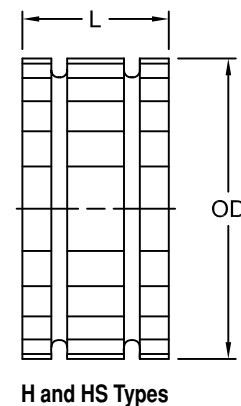

Sleeve Dimensional Data

Size	Types JE, JES, JN & JNS			Types E & N			Types H & HS		
	EPDM & Neoprene			EPDM & Neoprene			Hytrel		
	L	OD	Weight	L	OD	Weight	L	OD	Weight
	in	in	lbs	in	in	lbs	in	in	lbs
3	1.00	1.88	0.06	—	—	—	—	—	—
4	1.25	2.31	0.10	—	—	—	—	—	—
5	1.56	2.94	0.20	1.56	2.94	0.25	—	—	—
6	1.88	3.75	0.40	1.88	3.75	0.49	1.88	3.75	0.44
7	2.19	4.34	0.62	2.19	4.34	0.77	2.19	4.34	0.69
8	2.50	5.06	1.13	2.50	5.06	1.40	2.50	5.06	1.40
9	3.00	6.00	1.46	3.00	6.00	2.00	3.00	6.00	1.80
10	3.44	7.06	2.32	3.44	7.06	3.20	3.44	7.06	2.90
11	—	—	—	4.00	8.19	5.10	4.00	8.19	4.50
12	—	—	—	4.69	9.56	8.10	4.69	8.56	7.30
13	—	—	—	5.50	11.19	13.00	5.50	11.19	11.80
14	—	—	—	6.50	13.09	21.10	6.50	13.09	19.30
16	—	—	—	8.75	17.91	45.30	—	—	—

Note: ■ See page SF-12 for Performance Data.

J Type Flanges and J Type Couplings

J Type Flanges

- The J Type flanges in sizes 3J and 4J are made from die cast of high strength zinc alloy (tensile strength of 41,000 psi) and are furnished bore-to-size
- Size 5J is provided in either zinc alloy or cast iron depending on the bore size
- Size 6J is made from cast iron
- J flanges are compatible with EPDM or Neoprene sleeves
- Each flange has a keyway and two set screws (one set screw over the key and one at 90° to the keyway)

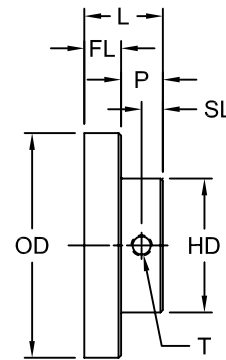

J Type Flange

J Type Coupling

- Complete S-Flex couplings, with J Type flanges described above, are normally supplied with the one-piece JE sleeve or the one-piece split JES sleeve. An optional JN (Neoprene, one-piece) sleeve or the one-piece split JNS sleeve
- Sizes 5J and 6J couplings are also available with E and N two piece sleeves

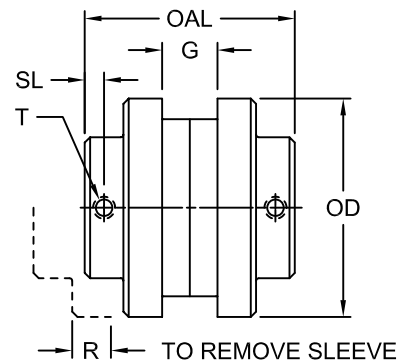

J Type Coupling

J Type Dimensional Data

Size	Max Bore with Standard Keyway	L in	FL in	P in	SL in	OD in	T in	HD in	OAL in	G ¹ in	R in	Weight	
												Flange lbs	Coupling lbs
3J	0.875	0.81	0.38	0.44	0.25	2.062	1/4-20	1.50	2.00	0.44	0.56	0.30	0.68
4J	1.000	0.88	0.44	0.44	0.25	2.460	1/4-20	1.63	2.38	0.63	0.75	0.40	0.89
5J	1.125	1.06	0.59	0.47	0.29	3.250	1/4-20	1.88	2.88	0.75	0.97	1.10	2.40
6J	1.375	1.31	0.78	0.53	0.29	4.000	5/16-18	2.50	3.50	0.88	1.09	1.90	4.36

- Notes: ■ 1 indicates: Spacing between shafts should be greater than 1/8 inch and less than OAL minus the sum of the two bore dimensions.
 ■ See page SF-12 for Performance Data.

S Type Flanges and S Type Couplings

S Type Flanges

- S flanges are made of high strength cast iron and are bored-to-size for a slip fit on standard shafts
- S flanges are easy to install, are readily available from stock in a wide range of popular bore sizes, and are supplied with two set screws at 90°

S Type Couplings

- S Type couplings, normally supplied with the two-piece E sleeve, can be used with any JE, JN, N, H, or HS sleeves

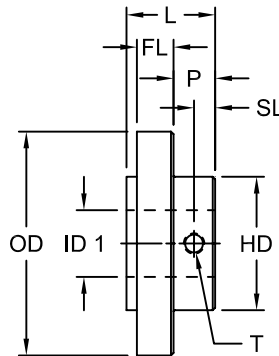

S Type Flange

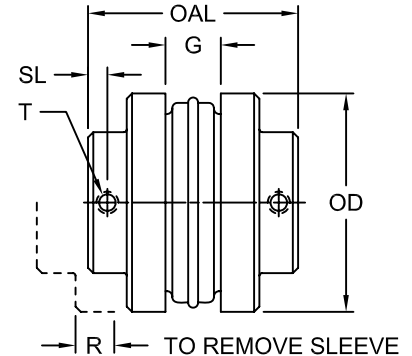

S Type Coupling

S Type Dimensional Data

Size	ID1		L	FL	P	SL	OD	T	HD	OAL	G	R	Weight Flange lbs
	Max Bore Standard Keyway in	Max Bore Shallow Keyway in											
5S	1.188	1.250	1.34	0.59	0.45	0.29	3.250	1/4-20	1.88	2.81	0.75	0.97	1.1
6S	1.438	1.500	1.64	0.78	0.53	0.29	4.000	5/16-18	2.50	3.50	0.88	1.09	1.9
	—	1.750	1.64	0.78	0.53	—	4.000	—	2.50	3.50	0.88	1.09	1.8
7S	1.625	1.875	1.84	0.78	0.69	0.35	4.625	3/8-16	2.81	3.94	1.00	1.31	2.6
8S	1.938	2.250	2.10	0.88	0.75	0.38	5.450	3/8-16	3.25	4.39	1.13	1.50	4.4
	—	2.375	1.94	0.88	1.03	—	5.450	—	3.25	4.95	1.13	1.50	3.7
9S	2.375	2.500	2.41	1.03	0.78	0.41	6.350	1/2-13	3.63	5.06	1.44	1.75	6.5
	—	2.875	2.28	1.03	1.25	—	6.350	—	4.13	6.00	1.44	1.75	6.2
10S	2.750	3.125	2.70	1.22	0.81	0.41	7.500	1/2-13	4.38	5.69	1.63	2.00	10.5
	—	3.375	2.70	1.22	0.81	—	7.500	—	4.75	5.69	1.63	2.00	9.8
11S	3.375	3.625	3.44	1.50	1.13	0.56	8.625	1/2-13	5.25	7.13	1.88	2.38	16.6
	—	3.875	3.06	1.50	1.56	—	8.625	—	5.63	8.00	1.88	2.38	16.4
12S	2.875	—	4.00	1.69	1.28	0.63	10.000	1/2-13	4.88	8.25	2.31	2.69	27.5
	3.875	3.938	4.00	1.69	1.28	—	10.000	—	5.75	8.25	2.31	2.69	26.6
13S	4.500	—	4.38	1.97	1.31	0.81	11.750	5/8-11	6.75	9.25	2.69	3.06	45.0
14S	5.000	—	4.50	2.25	1.06	0.62	13.875	5/8-11	7.50	9.88	3.25	3.50	69.0
16S	5.500	6.000	6.00	2.75	2.00	1.00	18.875	5/8-11	8.00	14.50	4.75	4.25	125.0

- Notes: ■ Spacing between shafts should be greater than 1/8 inch and less than OAL minus the sum of the two bore dimensions.
 ■ See page SF-12 for Performance Data.
 ■ The sizes with two dimensions listed indicate measurements for standard flanges (1st Line) and modified spacer flanges (2nd Line). See page SF-20.

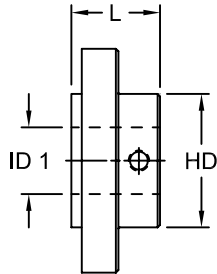

S Type



S Type with E Sleeve

S Type Shallow Keyway Dimensional Data

Size	L in	ID1		HD in	Shallow Keyway Dimensions									
		Max Bore Standard Keyway in	Max Bore Shallow Keyway in		Bore in	Keyway in	Key in	Bore in	Keyway in	Key in	Bore in	Keyway in	Key in	
		5S	1.34		1.188	1.250	1.88	1.25	.25 x .06	.25 x .19 x 1.38	—	—	—	—
6S	1.63	1.438	1.500	2.50	1.50	.38 x .13	.38 x .31 x 1.5	—	—	—	—	—	—	—
	1.31	—	1.750	2.50	1.56-1.63	.38 x .13	.38 x .31 x 1.31	1.69-1.75	.38 x .06	.38 x .25 x 1.25	—	—	—	
7S	1.84	1.625	1.875	2.81	1.69-1.75	.38 x .13	.38 x .31 x 1.81	1.81-1.88	.5 x .13	.5 x .38 x 1.81	—	—	—	
8S	2.09	1.938	2.250	3.25	2-2.25	.5 x .19	.5 x .44 x 2.06	—	—	—	—	—	—	
	1.94	—	2.375	3.25	—	—	—	2.31-2.38	.63 x .13	.63 x .44 x 1.88	—	—	—	
9S	2.41	2.375	2.500	3.63	2.44-2.5	.63 x .19	.63 x .5 x 2.38	—	—	—	—	—	—	
	2.28	—	2.875	4.13	—	—	—	2.56-2.75	.63 x .19	.63 x .5 x 2.25	2.81-2.88	.75 x .13	.75 x .5 x 2.25	
10S	2.72	2.750	3.125	4.38	2.81-3.13	.75 x .13	.75 x .5 x 2.75	—	—	—	—	—	—	
	2.69	—	3.375	4.75	—	—	—	3.18-3.25	.75 x .13	.75 x .5 x 2.63	3.31-3.38	.88 x .19	.88 x .63 x 2.63	
11S	3.44	3.375	3.625	5.25	3.44-3.63	.88 x .19	.88 x .63 x 3.44	—	—	—	—	—	—	
	3.06	—	3.875	5.63	—	—	—	3.69-3.75	.88 x .19	.88 x .63 x .3	3.88	1 x .25	1 x .75 x 3	
12S	4.00	2.875	—	4.88	—	—	—	—	—	—	—	—	—	
	4.00	3.875	3.938	5.75	3.94	1 x .13	1 x .63 x 4	—	—	—	—	—	—	
13S	4.38	4.500	—	6.75	—	—	—	—	—	—	—	—	—	
14S	4.50	5.000	—	7.50	—	—	—	—	—	—	—	—	—	
16S	6.00	5.500	6.000	8.00	5.56-6	1.5 x .25	1.5 x 1 x 6	—	—	—	—	—	—	

Notes: ■ Some large bore S Type flanges are supplied with shallow keyways as standard. Rectangular keystock is provided for stock bores only.
 ■ See page SF-12 for Performance Data.

B Type Flanges For Use With Bushings

B Type Flange

- Model B (bushed) flanges are made of the same high-strength cast iron as the S flanges
- B flanges are designed to accommodate the industry standard bushing for easy installation and removal
- B flanges are available in sizes 6 through 16

Couplings

- S-Flex couplings with B flanges (for use with bushings) are normally supplied with the two-piece E sleeve
- The B style flanges can be used with any of the sleeves pictured on SF-5, with the exception of the Hytre[®] sleeve
- B flanges can be used in combination with S Type flanges

Bushings

- Bushings have a split design that allow for a compression fit for secure mounting of the flange to the shaft without set screws
- The bushing's clamp like fit creates a one-piece assembly to eliminate wobble, vibration, and fretting corrosion
- Slightly oversized or undersized shafts can be accommodated with the same secure grip
- The design prevents potentially hazardous key drift on applications subject to pulsation or vibration
- B flanges are bored to accept a bushing accommodating many bore sizes, thus reducing inventory and increasing coupling versatility
- Bushing bore availability can be found in current Lovejoy list price books or from your Customer Service Representative

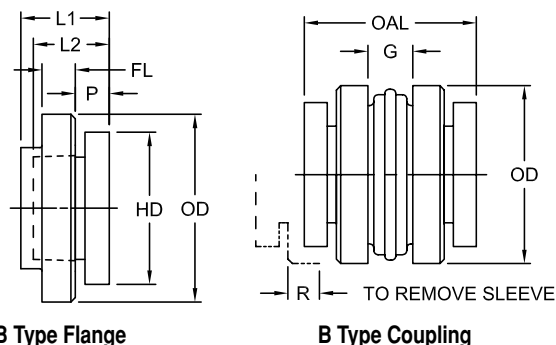

B Type Flange

B Type Coupling

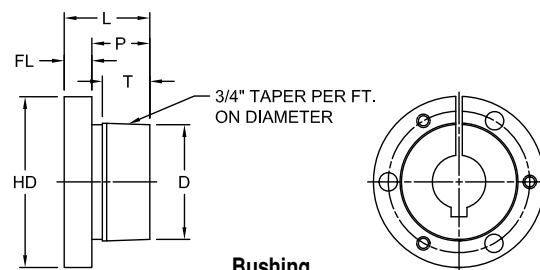

Bushing

B Type Flange and Coupling Dimensional Data

Size	Flange UPC Number	Bushing Required	L1 in	L2 in	FL in	P in	OD in	HD in	OAL in	G in	R Max in	Approx Bore in	Flange Weight lbs
6B	36369	JA	1.53	1.00	0.78	0.44	4.000	2.00	3.31	0.88	1.09	1.19	1.3
7B	36371	JA	1.59	1.00	0.78	0.44	4.625	2.00	3.44	1.00	1.31	1.19	1.9
8B	36373	SH	1.84	1.25	0.91	0.50	5.450	2.69	3.94	1.13	1.50	1.63	2.9
9B	36375	SD	2.19	1.81	1.03	0.56	6.350	3.19	4.63	1.44	1.75	1.94	4.8
10B	35421	SK	1.84	1.88	1.22	0.63	7.500	3.88	5.31	1.63	2.00	2.50	7.8
11B	35432	SF	2.13	2.00	1.50	0.63	8.625	4.63	6.13	1.88	2.38	2.75	12.0
12B	36408	E	2.69	2.63	1.69	0.88	10.000	6.00	7.44	2.31	2.69	3.44	18.0
13B	35444	F	3.69	3.63	1.97	1.00	11.750	6.63	8.63	2.69	3.00	3.94	31.2
14B	35447	F	3.69	3.63	2.25	1.00	13.875	6.63	9.75	3.25	3.50	3.94	51.4
16B	35449	J	4.75	4.50	2.75	1.19	18.875	7.25	12.63	4.75	4.25	4.50	120.0

Note: ■ 1 indicates: Spacing between shafts should be greater than 1/8 inch and less than G. Spacing between internal face of flange should be OAL - (2 x L1).

Bushing Dimensional Data

Size	L in	P in	FL in	T in	HD in	D in	ID1 - ID2			Number & Size of Cap Screws Req Qty	Cap Screw Torque ft-lb	Weight lbs	
							Min Bore in	Max Bore Std Keyway in	Max Bore Shallow Keyway2 in				
JA	1.00	0.69	0.31	0.56	2.00	1.375	0.50	1.00	1.19	3	#10 - 1	5	0.8
SH	1.25	0.88	0.38	0.81	2.68	1.871	0.50	1.38	1.63	3	1/4 - 1-3/8	9	0.9
SD	1.81	1.38	0.44	1.25	3.18	2.187	0.50	1.63	1.94	3	1/4 - 1-13/16	9	1.6
SK	1.87	1.38	0.50	1.25	3.88	2.812	0.50	2.13	2.50	3	5/16 - 2	15	2.8
SF	2.00	1.50	0.50	1.25	4.63	3.125	0.50	2.31	2.81	3	3/8 - 2	30	3.9
E	2.63	1.88	0.75	1.63	6.00	3.834	0.88	2.88	3.50	3	1/2 - 2-3/4	60	8.5
F	3.63	2.81	0.81	2.50	6.63	4.438	1.00	3.25	3.94	3	9/16 - 3-5/8	75	13.9
J	4.50	3.50	1.00	3.19	7.25	5.148	1.44	3.75	4.50	3	5/8 - 4-1/2	135	21.6

Notes: ■ F and J bushings are not available from Lovejoy. F bushings are available commercially in a bore range of 1 inch to 4 inches, J bushings in a range of 1-7/8 inches to 4-1/2 inches.

- Rectangular keys are furnished at no charge when shallow keyway is necessary.
- See page SF-12 for Performance Data.

T Type Flanges For Use With Taper-Lock® Bushings

TF Type Flanges

- Model TF flanges are made from the same high-strength cast iron as the S flanges, but are designed to accommodate the international standard Taper Lock bushing for easy installation and removal
- TF Type flanges allow for mounting the bushing on the front (hub) side of the flange
- TF flanges are available in sizes 6 through 16 and can be used with any style of sleeve as pictured on page SF-5

TR Type Flanges

- TR flanges are similar to the TF style, but allow for the Taper Lock Bushing to be mounted and removed from the reverse or serration side of the flange
- The limited torque ratings of the Taper Lock Bushings allow TR flanges to only be used with EPDM or Neoprene sleeves
- Different bushing sizes are used, so they have different maximum bores than the TF flanges
- Sizes 6 through 16 are available

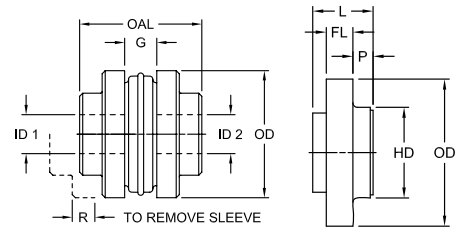

Note: ■ Be sure to determine if the bushing being used has either UNC threads (60°) or British Standard Whitworth B.S.W. threads (55°). In the U.S.A. the UNC type is predominant for both inch and metric bores. Outside of the U.S.A. it is most common to see B.S.W., especially on metric bores.

Taper-Lock Bushings

- The industry standard taper lock bushing is a split design allowing a compression fit of the flange to the shaft without set screws
- The simple design makes the installation and removal easy while the 8° taper grips tight and provides excellent concentricity
- A Reduced level of inventory can be achieved due to the many other power transmission components that use Taper Lock Bushings such as: sheaves, sprockets, and pulleys
- Lovejoy does not offer the Taper-Lock Bushings themselves as these are widely available from other manufacturers

Taper Dimensional Data (Front Mount)

Size	UNC Flange UPC Number	BSW Flange UPC Number	OAL in	G in	ID1 - ID2 Max Bore		R in	OD in	L in	FL in	P in	HD in	Bushing Screw Size in	Flange Weight lbs	Bushing Required*
					in	mm									
6TF	62265	62263	4.00	0.88	1.25	31	1.09	4.00	1.56	0.78	0.78	2.81	3/8 - 16	1.8	1215/1210
7TF	62269	62267	3.94	1.00	1.25	31	1.31	4.62	1.84	0.78	0.69	2.81	3/8 - 16	2.6	1215/1210
8TF	62273	62271	5.00	1.13	1.62	42	1.50	5.45	1.94	0.91	1.03	3.25	3/8 - 16	3.7	1615/1610
9TF	62277	62275	6.00	1.44	2.00	50	1.75	6.35	2.28	1.03	1.25	4.13	7/16 - 14	6.2	2012
10TF	62281	62279	7.00	1.63	2.50	64	2.00	7.50	2.69	1.22	1.47	4.75	1/2 - 13	9.8	2517
11TF	62285	62283	8.00	1.88	2.50	64	2.38	8.63	3.06	1.50	1.56	5.63	1/2 - 13	16.4	2517
12TF	62289	62287	8.25	2.31	3.00	76	2.69	10.00	4.00	1.69	1.28	5.75	5/8 - 11	26.6	3030
13TF	62293	62294	9.25	2.69	3.00	76	3.06	11.75	4.38	1.97	1.31	6.75	5/8 - 11	45.0	3030
14TF	62297	62295	9.88	3.25	3.94	100	3.50	13.88	4.50	2.25	1.06	7.50	1/2 - 13	69.0	3535
16TF	62301	62299	14.50	4.75	4.44	112	4.25	18.88	6.00	2.75	2.00	8.00	5/8 - 11	125.0	4040

Taper Dimensional Data (Rear Mount)

Size	UNC Flange UPC Number	BSW Flange UPC Number	OAL in	G in	ID1 - ID2 Max Bore		R in	OD in	L in	FL in	P in	HD in	Bushing Screw Size in	Flange Weight lbs	Bushing Required*
					in	mm									
6TR	62266	62264	4.00	0.88	1.00	25	1.09	4.00	1.56	0.78	0.78	2.81	1/4 - 20	1.8	1008
7TR	62270	62268	3.94	1.00	1.12	28	1.31	4.62	1.84	0.78	0.69	2.81	1/4 - 20	2.6	1108
8TR	62274	62272	5.00	1.13	1.25	31	1.50	5.45	1.94	0.91	1.03	3.25	3/8 - 16	3.7	1215/1210
9TR	62278	62276	6.00	1.44	1.62	42	1.75	6.35	2.28	1.03	1.25	4.13	3/8 - 16	6.2	1615/1610
10TR	62282	62280	7.00	1.63	1.62	42	2.00	7.50	2.69	1.22	1.47	4.75	3/8 - 16	9.8	1615/1610
11TR	62286	62284	8.00	1.88	2.50	64	2.38	8.63	3.06	1.50	1.56	5.63	1/2 - 13	16.4	2525
12TR	62290	62288	8.25	2.31	2.50	64	2.69	10.00	4.00	1.69	1.28	5.75	1/2 - 13	26.6	2517
13TR	62294	62292	9.25	2.69	3.00	76	3.06	11.75	4.38	1.97	1.31	6.75	5/8 - 11	45.0	3030
14TR	62298	62296	9.88	3.25	3.00	76	3.50	13.88	4.50	2.25	1.06	7.50	5/8 - 11	69.0	3030
16TR	62302	62300	14.50	4.75	4.44	112	4.25	18.88	6.00	2.75	2.00	8.00	5/8 - 11	125.0	4040

- Notes: ■ All above data refers to both standard UNC and British Standard Whitworth B.S.W. threads. Flanges are not supplied with screws.
 ■ * indicates that use of a 1210 or 1610 bushing reduces the reserve factor between bushing torque rating and that of the coupling.
 ■ Taper-Lock® is a registered trademark of Reliance Electric Industrial Company in the United States and Canada. It is a registered trademark of JH Fenner and Co. in the United Kingdom.
 ■ See page SF-12 for Performance Data.

SC Type Spacer Couplings

SC Type Spacer Couplings

- Specifically designed for the pump industry, this coupling accommodates industry standard as well as special pump/motor separation
- This shaft separation facilitates easy pump repair of pump packing, bearings, and seals without disturbing pump or motor mounting and alignment
- The SC Type coupling consists of two flanges, a sleeve and two shaft hubs

Quick Coupling Removal

- The center drop out section consists of two flanges and the flexible sleeve
- The flange is bolted to the shaft hub with four hex head cap screws
- The center drop out section can be removed by removing the hex head cap screws
- Flats on each hub provides a convenient grip for a wrench in order to facilitate loosening of the screws and, if desired, turning of the pump/motor shafts
- Once the hub is removed from the pump shaft, maintenance on the pump can be done without disturbing equipment alignment

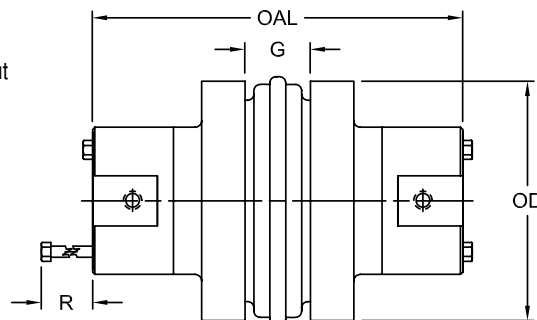

SF

SC Type (Spacer) Dimensional Data

Size	For Required Shaft Separation in	Use Flange Number	Use Hub Number	OAL ² in	G in	R in	OD in	Weight Complete Coupling ² lbs
5SC	3.50	5SC35	5SCH	5.63	0.75	0.56	3.250	4.5
6SC	3.50	6SC35	6SCH	5.88	0.88	0.75	4.000	7.3
	4.38	6SC44	6SCH	6.75	0.88	0.75	4.000	8.1
7SC	5.00	6SC50	6SCH	7.38	0.88	0.75	4.000	8.7
	3.50	7SC35	7SCH	6.38	1.00	0.63	4.625	9.9
	4.38	7SC44	7SCH	7.25	1.00	0.63	4.625	10.8
8SC	5.00	7SC50	7SCH	7.88	1.00	0.63	4.625	11.4
	3.50	8SC35	8SCH	6.88	1.13	0.81	5.450	15.2
	3.50	8SC35-10	10SCH ¹	8.13	1.13	0.81	5.450	23.2
	4.38	8SC44	8SCH	7.75	1.13	0.81	5.450	16.4
9SC	5.00	8SC50	8SCH	8.38	1.13	0.81	5.450	17.4
	5.00	8SC50-10	10SCH ¹	9.63	1.13	1.19	5.450	27.2
	3.50	9SC35	9SCH ¹	7.50	1.44	1.06	6.350	18.6
	5.00	9SC450	9SCH ¹	8.88	1.44	1.06	6.350	23.2
	5.00	9SC50-11	11SCH ¹	10.38	1.44	1.19	6.350	40.4
10SC	7.00	9SC70-11	11SCH ¹	12.38	1.44	1.19	6.350	48.2
	7.75	9SC78-11	11SCH ¹	13.13	1.44	1.19	6.350	51.0
	4.75	10SC48	10SCH ¹	9.38	1.63	1.19	7.500	37.6
	5.00	10SC50	10SCH ¹	9.63	1.63	1.19	7.500	38.4
11SC	7.00	10SC70-13	13SCH ¹	13.63	1.63	1.88	7.500	72.0
	7.75	10SC78-13	13SCH ¹	14.38	1.63	1.88	7.500	76.0
	10.00	10SC100-13	13SCH ¹	16.63	1.63	1.88	7.500	88.0
	4.75	11SC48	11SCH ¹	10.31	1.88	1.19	8.625	54.5
12SC	5.00	11SC50	11SCH ¹	10.38	1.88	1.19	8.625	54.7
	7.00	11SC70-14	14SCH	14.63	1.88	2.00	8.625	86.1
	7.75	11SC78-14	14SCH	15.38	1.88	2.00	8.625	90.3
	10.00	11SC100-14	14SCH	17.63	1.88	2.00	8.625	102.7
13SC	7.00	12SC70	12SCH ¹	12.88	2.31	1.50	10.000	88.1
	7.00	12SC70-14	14SCH	14.63	2.31	2.00	10.000	99.1
	7.75	12SC78	12SCH ¹	13.63	2.31	1.50	10.000	91.9
	7.75	12SC78-14	14SCH	15.38	2.31	2.00	10.000	103.3
14SC	7.75	13SC78	13SCH ¹	14.38	2.69	1.88	11.750	129.6
14SC	7.75	14SC78	14SCH	15.38	3.25	2.00	13.875	179.9

Notes : ■ 1 indicates: SC Hubs are available in: SC= Standard Length SCHS= Short Length.
 ■ 2 indicates: OAL dimension and weight will vary if one or two short (HS) hubs are used.
 ■ See page SF-12 for Performance Data.

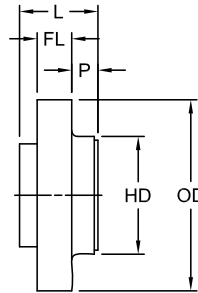

SC Type (Spacer) Flange Dimensional Data

SF

Size	Flange Number	For Required Shaft Separation ¹	SC Hub Number	L in	FL in	P in	OD in	HD in	Weight Each Flange lbs
5SC	5SC35	3.50	5SCH	1.69	0.59	0.80	3.250	0.80	1.3
6SC	6SC35	3.50	6SCH	1.63	0.72	0.59	4.000	0.59	2.0
	6SC44	4.38	6SCH	2.06	0.72	1.03	4.000	1.03	2.4
	6SC50	5.00	6SCH	2.38	0.72	1.34	4.000	1.34	2.7
7SC	7SC35	3.50	7SCH	1.63	0.78	0.47	4.625	0.47	2.5
	7SC44	4.38	7SCH	2.06	0.78	0.91	4.625	0.91	3.0
	7SC50	5.00	7SCH	2.38	0.78	1.22	4.625	1.22	3.3
8SC	8SC35	3.50	8SCH	1.63	0.91	0.28	5.450	0.28	3.7
	8SC35-10	3.50	10SCH(HS)	1.63	0.91	0.28	5.450	0.28	3.5
	8SC44	4.38	8SCH	2.06	0.91	0.72	5.450	0.72	4.3
	8SC50	5.00	8SCH	2.38	0.91	1.03	5.450	1.03	4.8
	8SC50-10	5.00	10SCH(HS)	2.38	0.91	1.03	5.450	1.03	5.5
9SC	9SC35	3.50	9SCH(HS)	1.69	1.03	0.06	6.350	0.06	4.1
	9SC44	4.38	9SCH(HS)	2.06	1.03	0.44	6.350	0.44	5.9
	9SC450	5.00	9SCH(HS)	2.38	1.03	0.75	6.350	0.75	6.4
	9SC50-11	5.00	11SCH(HS)	2.38	1.03	0.75	6.350	0.75	7.0
	9SC70-11	7.00	11SCH(HS)	2.38	1.03	0.75	6.350	1.75	10.9
	9SC78-11	7.75	11SCH(HS)	3.75	1.03	1.75	6.350	2.13	12.3
10SC	10SC48	4.75	10SCH(HS)	2.25	1.22	2.13	7.500	0.34	9.8
	10SC50	5.00	10SCH(HS)	2.38	1.22	0.34	7.500	0.47	10.2
	10SC70-13	7.00	13SCH(HS)	3.38	1.22	0.47	7.500	1.47	14.5
	10SC78-13	7.75	13SCH(HS)	3.75	1.22	1.47	7.500	1.84	16.5
	10SC100-13	10.00	13SCH(HS)	4.88	1.22	1.84	7.500	2.97	22.5
11SC	11SC48	4.75	11SCH(HS)	1.50	1.50	2.97	8.625	0.03	12.5
	11SC50	5.00	11SCH(HS)	1.56	1.50	0.03	8.625	0.06	12.6
	11SC70-14	7.00	14SCH	2.56	1.50	0.06	8.625	1.06	16.3
	11SC78-14	7.75	14SCH	2.94	1.50	1.44	8.625	1.44	18.4
	11SC100-14	10.00	14SCH	4.06	1.50	2.56	8.625	2.56	24.6
12SC	12SC70	7.00	12SCH(HS)	2.47	1.69	0.66	10.000	0.66	23.4
	12SC70-14	7.00	14SCH	2.47	1.69	0.66	10.000	0.66	21.3
	12SC78	7.75	12SCH(HS)	2.84	1.69	1.03	10.000	1.03	25.3
	12SC78-14	7.75	14SCH	2.84	1.69	1.03	10.000	1.03	23.4
	12SC100-14	10.00	14SCH	3.97	1.69	2.16	10.000	2.16	29.6
13SC	13SC78	7.75	13SCH(HS)	3.25	1.97	0.56	11.750	0.56	38.4
14SC	14SC78	7.75	14SCH	2.72	2.25	0.03	13.875	0.03	55.2

Notes: ■ 1 indicates: Flanges can be mixed to form different shaft separations.
 ■ Metric Flanges and hubs are also available. Consult Lovejoy Engineering for specific information.
 ■ See page SF-12 for Performance Data.

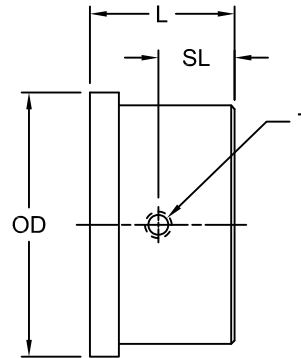

SF

SC Type (Spacer) Hub Dimensional Data

Size	Hub Number ¹	ID1 - ID2	L in	SL in	OD in	T in	Number & Size of Cap Screws Req		Weight Hub lbs
		Max Bore Standard Keyway in					Qty	Size	
5SC	5SCH	1.125	1.09	0.54	2.00	5/16 - 18	4	#10 - 1-1/2	0.8
6SC	6SCH	1.375	1.22	0.61	2.50	5/16 - 18	4	1/4 - 1-3/4	1.4
7SC	7SCH	1.625	1.47	0.71	2.81	5/16 - 18	4	1/4 - 1-7/8	2.0
8SC	8SCH	1.875	1.72	0.66	3.25	3/8 - 16	4	5/16 - 2-1/4	3.2
	10SCH	2.375	2.34	0.63	4.38	1/2 - 13	4	7/16 - 3-1/4	7.4
	10SCHS	1.625	1.66	0.63	4.38	1/2 - 13	4	7/16 - 2-1/2	5.5
9SC	9SCH	2.125	1.97	1.17	3.63	3/8 - 16	4	3/8 - 2-3/4	4.2
	9SCHS	1.500	1.53	0.63	3.63	3/8 - 16	4	5/8 - 4-1/2	3.7
	11SCH	2.875	2.72	1.36	5.25	1/2 - 13	4	1/2 - 3-1/2	12.2
	11SCHS	1.875	1.91	0.75	5.25	1/2 - 13	4	1/2 - 2-3/4	9.3
10SC	10SCH	2.375	2.34	1.17	4.38	1/2 - 13	4	7/16 - 3-1/4	7.4
	10SCHS	1.625	1.66	0.63	4.38	1/2 - 13	4	7/16 - 2-1/2	5.5
	13SCH	3.375	3.34	1.65	6.13	3/4 - 10	4	5/8 - 4-3/4	19.9
	13SCHS	2.500	2.47	1.24	6.13	3/4 - 10	4	5/8 - 3-1/2	16.0
11SC	11SCH	2.875	2.72	1.36	5.25	1/2 - 13	4	1/2 - 3-1/2	12.2
	11SCHS	1.875	1.91	0.75	5.25	1/2 - 13	4	1/2 - 2-3/4	9.3
	14SCH	3.875	3.84	1.92	6.50	3/4 - 10	4	5/8 - 5	24.2
12SC	12SCH	2.875	2.97	1.44	5.75	5/8 - 11	4	5/8 - 4	16.6
	12SCHS	2.500	2.53	1.12	5.75	5/8 - 11	4	5/8 - 3-1/2	14.1
	14SCH	3.875	3.84	1.92	6.50	3/4 - 10	4	5/8 - 5	24.2
13SC	13SCH	3.375	3.34	1.65	6.13	3/4 - 10	4	5/8 - 4-3/4	19.9
	13SCHS	2.500	2.47	1.24	6.13	3/4 - 10	4	5/8 - 3-1/2	16.0
14SC	14SCH	3.875	3.38	1.92	6.50	3/4 - 10	4	5/8 - 5	24.2

Notes: ■ 1 indicates: SCH = Standard length SCHS = Short length.
 ■ See page SF-12 for Performance Data.

SC Type (Spacer)

- SC (Spacer) Type couplings are available with the most popular shaft separation distances
- Non standard shaft separations can be achieved by combining different spacer flanges
- The "Standard" column illustrates separations available using identical lengths
- The "Combination" column illustrates combined flanges of different separations
- The "Semi-Spacer" column illustrates combinations of SC (Spacer) flanges and standard S flanges



SF

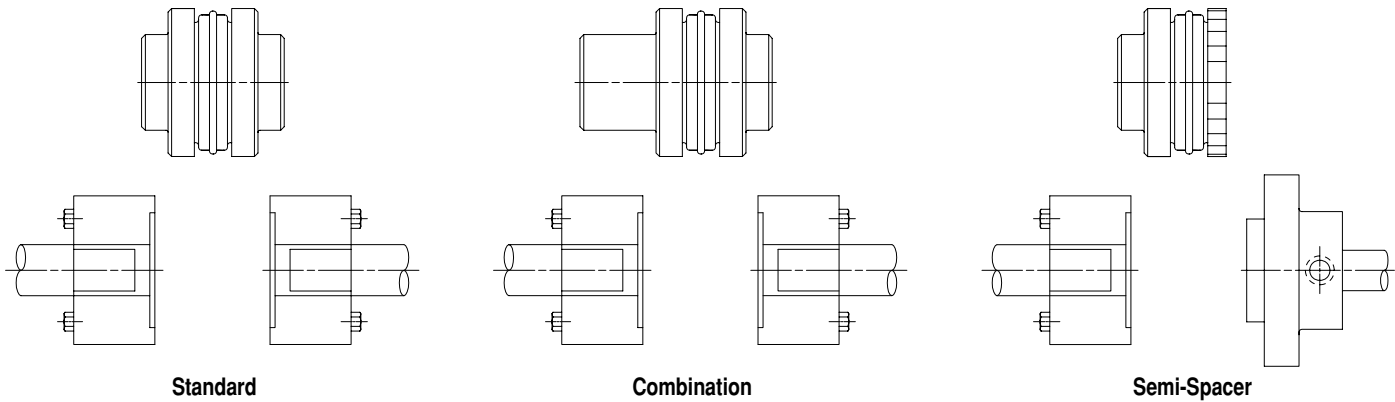

Type SC (Spacer) Dimensional Data

Standard

Spacing	Use Flanges
3-1/2	(2)-SC35
4-3/8	(2)-SC44
5	(2)-SC50
7	(2)-SC70
7-3/4	(2)-SC78
10	(2)-SC100

Combination

Spacing	Use Flanges ¹
3-15/16	SC35 & SC44
4-1/4	SC44 & SC50
5-1/4	SC35 & SC70
5-5/8	SC35 & SC78
5-11/16	SC44 & SC70
6	SC50 & SC70
6-1/16	SC44 & SC78
6-3/8	SC50 & SC78
6-3/4	SC35 & SC100 ²
7-3/16	SC44 & SC100 ²
7-3/8	SC70 & SC78
7-1/2	SC50 & SC100
8-1/2	SC70 & SC100
8-7/8	SC78 & SC100

Semi-Spacer

Spacing	Use Flanges ¹
1-7/8	S & SC35
2-5/16	S & SC44
2-5/8	S & SC50
3-5/8	S & SC70
4	S & SC78
5-1/8	S & SC100

- Notes: ■ 1 indicates: Check for flange availability of coupling size.
 ■ 2 indicates: Non stock.
 ■ See page SF-12 for Performance Data.