

## Quick start guide





February 2010

**Important notice—please read**

The product discussed in this literature is subject to terms and conditions outlined in Eaton selling policies. The sole source governing the rights and remedies of any purchaser of this equipment is the relevant Eaton selling policy.

NO WARRANTIES, EXPRESS OR IMPLIED, INCLUDING WARRANTIES OF FITNESS FOR A PARTICULAR PURPOSE OR MERCHANTABILITY, OR WARRANTIES ARISING FROM COURSE OF DEALING OR USAGE OF TRADE, ARE MADE REGARDING THE INFORMATION, RECOMMENDATIONS AND DESCRIPTIONS CONTAINED HEREIN. In no event will Eaton be responsible to the purchaser or user in contract, in tort (including negligence), strict liability or otherwise for any special, indirect, incidental or consequential damage or loss whatsoever, including but not limited to damage or loss of use of equipment, plant or power system, cost of capital, loss of power, additional expenses in the use of existing power facilities, or claims against the purchaser or user by its customers resulting from the use of the information, recommendations and descriptions contained herein.

The information contained in this manual is subject to change without notice.

Cover Photo: Eaton's M-Max™ Series adjustable frequency drive.

## Table of contents

|   |            |
|---|------------|
| <b>List of Figures</b> .....                    | <b>iii</b> |
| <b>List of Tables</b> .....                     | <b>iii</b> |
| <b>Safety</b>                                   |            |
| Definitions and symbols .....                   | iv         |
| Hazardous high voltage .....                    | iv         |
| Cautions .....                                  | v          |
| Notices .....                                   | v          |
| Danger and dangerous electrical voltage .....   | v          |
| Before commencing the installation .....        | v          |
| <b>M-Max Series</b>                             |            |
| About this manual .....                         | 1          |
| Notes about the M-Max product enhancement ..... | 1          |
| Writing conversions .....                       | 3          |
| Rated operational data on the nameplate .....   | 4          |
| Mains voltages .....                            | 4          |
| <b>Technical Data</b>                           |            |
| Control signal terminals .....                  | 8          |
| Block diagram .....                             | 10         |
| <b>Operation</b>                                |            |
| Checklist for commissioning .....               | 13         |
| Hazard warnings .....                           | 14         |
| <b>Error and Warning Messages</b>               |            |
| Introduction .....                              | 16         |
| Error messages .....                            | 16         |
| Acknowledge fault message (Reset) .....         | 16         |
| Fault log (FLT) .....                           | 17         |
| Alarm messages .....                            | 17         |
| <b>Parameters</b>                               |            |
| Control unit .....                              | 20         |
| Display unit .....                              | 22         |
| General information on menu navigation .....    | 23         |
| Setting parameters .....                        | 24         |
| Parameter menu (PAR) .....                      | 26         |
| Quick start wizard .....                        | 28         |
| Example: Motor parameters (P7) .....            | 29         |
| List of parameters .....                        | 30         |
| Quick configuration (basis) .....               | 30         |
| All Parameters .....                            | 33         |

February 2010

## List of figures

|   |    |
|---|----|
| Figure 1: M-Max Series Adjustable Frequency Drive . . . . .                           | 1  |
| Figure 2: Control Signal Terminals . . . . .  | 2  |
| Figure 3: Schematic Arrangement and Designation of Control Signal Terminals . . . . . | 8  |
| Figure 4: Block Diagram MMX11 . . . . .   | 10 |
| Figure 5: MMX12 Block Diagram . . . . .   | 11 |
| Figure 6: Block Diagram MMX32 and MMX34 . . . . .                                     | 12 |
| Figure 7: Error Message Example . . . . .   | 16 |
| Figure 8: Example of an Alarm Message . . . . .                                       | 17 |
| Figure 9: View: Control Unit With LCD Display, Function Keys, and Interface . . . . . | 20 |
| Figure 10: LCD Display (Areas) . . . . .  | 22 |
| Figure 11: Operational Data Indicator (Operational) . . . . .                         | 23 |
| Figure 12: Parameter Menu (P1.1 = 1, Quick-Configuration) . . . . .                   | 26 |
| Figure 13: Schematic Representation of Parameter Access . . . . .                     | 27 |
| Figure 14: Motor Parameters From Ratings Plate . . . . .                              | 29 |
| Figure 15: Circuits (Delta, Star) . . . . .   | 29 |

## List of tables

|   |    |
|---|----|
| Table 1: Nameplate Inscriptions . . . . .                                 | 4  |
| Table 2: General Rated Operational Data . . . . .                         | 5  |
| Table 3: Technical Data . . . . .   | 7  |
| Table 4: Cable Cross Section (Cu): 0.5 – 1.5 mm <sup>2</sup> . . . . .    | 9  |
| Table 5: List of Fault Messages (F) and Warning Messages (AL) . . . . .   | 18 |
| Table 6: Control Unit Elements . . . . .                                  | 20 |
| Table 7: Areas of the LCD Display . . . . .                               | 22 |
| Table 8: LCD Display in Operation . . . . .                               | 24 |
| Table 9: Quick Configuration . . . . .                                    | 30 |
| Table 10: Predefined Application Parameters From Parameter P1.2 . . . . . | 32 |
| Table 11: All Parameters . . . . .  | 33 |

## Safety

### Definitions and symbols

---

 **VOLTAGE**

---

This symbol indicates high voltage. It calls your attention to items or operations that could be dangerous to you and other persons operating this equipment. Read the message and follow the instructions carefully.



This symbol is the "Safety Alert Symbol." It occurs with either of two signal words: CAUTION or WARNING, as described below.

---

 **WARNING**

---

Indicates a potentially hazardous situation which, if not avoided, can result in serious injury or death.

---

 **CAUTION**

---

Indicates a potentially hazardous situation which, if not avoided, can result in minor to moderate injury, or serious damage to the product. The situation described in the CAUTION may, if not avoided, lead to serious results. Important safety measures are described in CAUTION (as well as WARNING).

### Hazardous high voltage

---

 **VOLTAGE**

---

Motor control equipment and electronic controllers are connected to hazardous line voltages. When servicing drives and electronic controllers, there may be exposed components with housings or protrusions at or above line potential. Extreme care should be taken to protect against shock.

Stand on an insulating pad and make it a habit to use only one hand when checking components. Always work with another person in case an emergency occurs. Disconnect power before checking controllers or performing maintenance. Be sure equipment is properly grounded. Wear safety glasses whenever working on electronic controllers or rotating machinery.

February 2010

## Cautions and notices

Read this manual thoroughly and make sure you understand the procedures before you attempt to install, set up, or operate Eaton's M-Max Series adjustable frequency drive.

### Cautions

---

**⚠ CAUTION**

---

Be **ABSOLUTELY** sure not to connect two functions to one and same output in order to avoid function overruns and to ensure flawless operation.

---

**⚠ CAUTION**

---

The calculated model does not protect the motor if the airflow to the motor is reduced by blocked air intake grill.

### Notices

---

**Notice**

---

The *inputs*, unlike the *outputs*, cannot be changed in RUN state.

## Danger and dangerous electrical voltage

### ***Before commencing the installation***

Disconnect the power supply of the device.

Ensure that devices cannot be accidentally restarted.

Verify isolation from the supply.

Earth and short circuit the device.

Cover or enclose any adjacent live components.

Follow the engineering instructions IL04020001E for the device concerned.

Only suitably qualified personnel in accordance with EN 50110-1/-2 (VDE 0105 Part 100) may work on this device/system.

Before installation and before touching the device, ensure that you are free of electrostatic charge.

The functional earth (FE, PES) must be connected to the protective earth (PE) or the potential equalization. The system installer is responsible for implementing this connection.

Connecting cables and signal lines should be installed so that inductive or capacitive interference does not impair the automation functions.

Install automation devices and related operating elements in such a way that they are well protected against unintentional operation.

Suitable safety hardware and software measures should be implemented for the I/O interface so that an open circuit on the signal side does not result in undefined states in the automation devices.

Ensure a reliable electrical isolation of the extra-low voltage of the 24V supply. Only use power supply units complying with IEC 60364-4-41 (VDE 0100 Part 410) or HD384.4.41 52.

Deviations of the mains voltage from the rated value must not exceed the tolerance limits given in the specifications, otherwise this may cause malfunction and dangerous operation.

Emergency stop devices complying with IEC/EN 60204-1 must be effective in all operating modes of the automation devices. Unlatching the emergency-stop devices must not cause a restart.

Devices that are designed for mounting in housings or control cabinets must only be operated and controlled after they have been installed and with the housing closed. Desktop or portable units must only be operated and controlled in enclosed housings.

Measures should be taken to ensure the proper restart of programs interrupted after a voltage dip or failure. This should not cause dangerous operating states even for a short time. If necessary, emergency-stop devices should be implemented.

Wherever faults in the automation system may cause injury or material damage, external measures must be implemented to ensure a safe operating state in the event of a fault or malfunction (for example, by means of separate limit switches, mechanical interlocks, etc.).

Depending on their degree of protection, frequency inverters may contain live bright metal parts, moving or rotating components, or hot surfaces during and immediately after operation.

Removal of the required covers, improper installation or incorrect operation of motor or frequency inverter may cause the failure of the device and may lead to serious injury or damage.

The applicable national accident prevention and safety regulations apply to all work carried on live frequency inverters.

The electrical installation must be carried out in accordance with the relevant regulations (e.g., with regard to cable cross sections, fuses, PE).

Transport, installation, commissioning and maintenance work must be carried out only by qualified personnel (IEC 60364, HD 384 and national occupational safety regulations).

Installations containing frequency inverters must be provided with additional monitoring and protective devices in accordance with the applicable safety regulations. Modifications to the frequency inverters using the operating software are permitted.



February 2010



February 2010

## M-Max™ Series

### About this manual

#### Notes about the M-Max Series product enhancement

This third edition of the quick reference guide describes the extended functionality (as of production date January 2010, see **Figure 1**) of the M-Max Series of adjustable frequency drives.

Key features of this enhancement are:

- New controller board with a higher-performance microprocessor
- Field bus interfaces on device side ①
- Two additional control keys ②
- Extended functionality of the digital and analog inputs and outputs ③

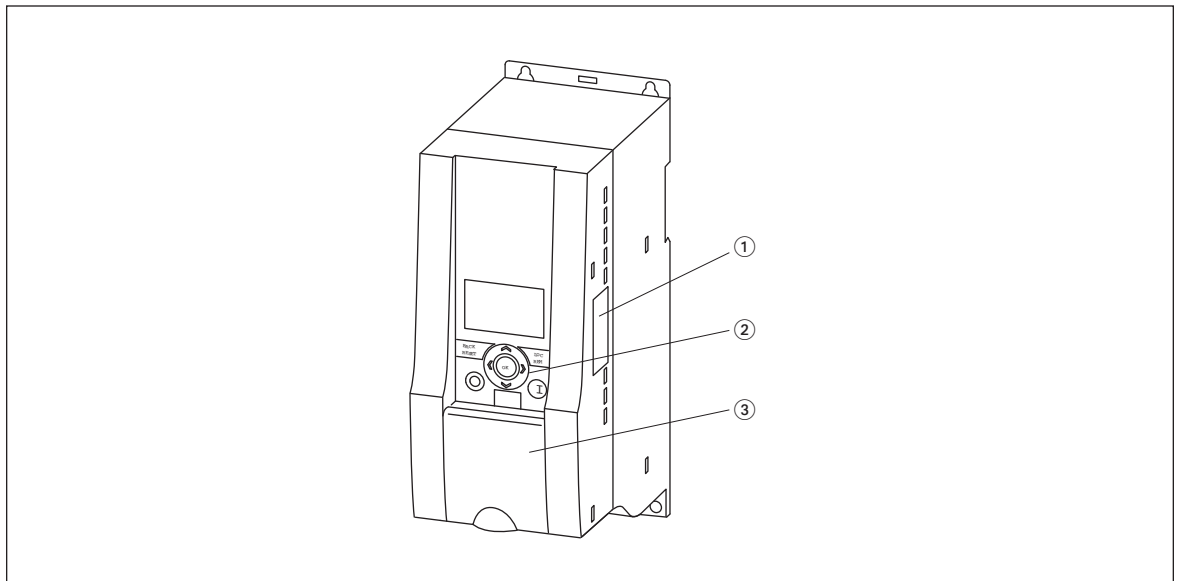

**Figure 1: M-Max Series Adjustable Frequency Drive**

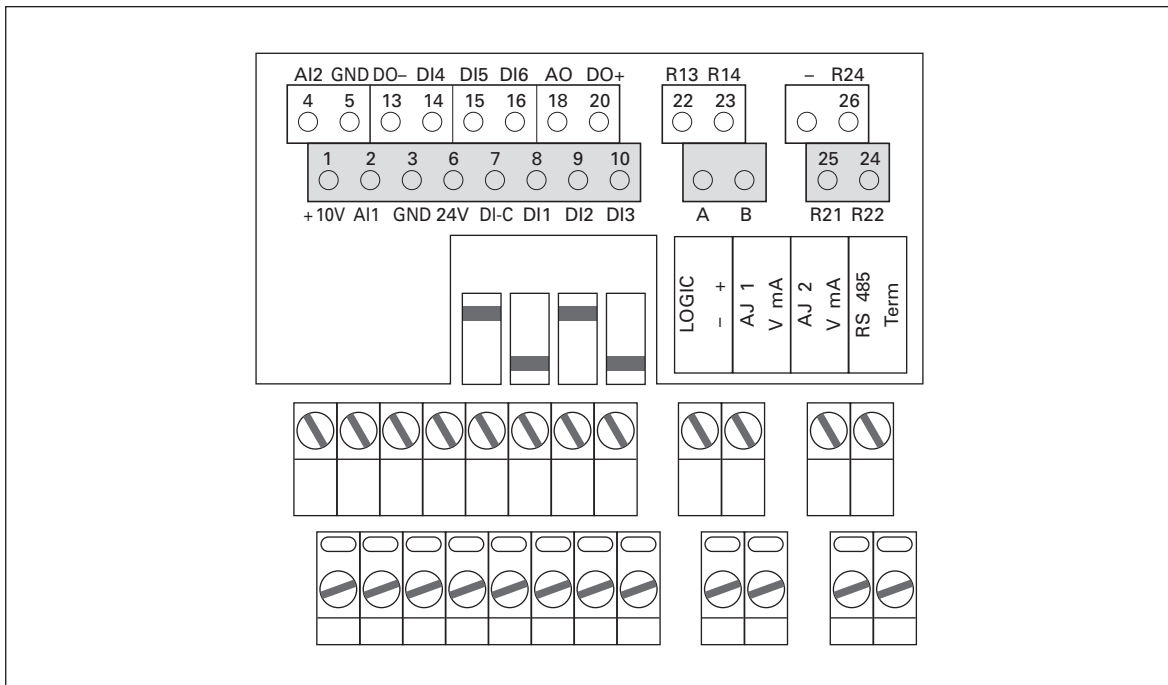

**Figure 2: Control Signal Terminals**

This quick reference guide contains selected information about the M-Max Series adjustable frequency drives.

This quick reference guide is a summary of manual MN04020001E and contains technical data, parameter lists and information about operating the adjustable frequency drives. It is intended to support experienced, qualified users in the use of the M-Max Series adjustable frequency drive.









It is assumed that you have thoroughly read manual MN04020001E and that the adjustable frequency drive has been correctly installed and commissioned as described in manual MN04020001E and installation instructions IL04020001E.

February 2010

## Writing conversions

The symbols used in this manual have the following meanings:

- ▶ Indicates instructions to be followed

|   |   |
|---|---|
|    | Indicates useful tips and additional information.   |
|    | <b>Caution!</b><br>warns of the risk of material damage.  |
|    | <b>Warning!</b><br>Warns about the possibility of serious property damage and minor injuries.   |
|    | <b>Danger!</b><br>Warns about the possibility of major property damage and serious injuries or death.   |
|    | In order to make it easier to follow the manual, the name of the current chapter is shown in the header of the left-hand page and the name of the current section is shown in the header of the right-hand page. This does not apply to pages at the start of a chapter or to empty pages at the end of a chapter.  |
|    | In order to make it easier to understand some of the figures included in this manual, the housing of the adjustable frequency drive, as well as other safety-relevant parts, have been left out. However, it is important to note that the adjustable frequency drive must only be operated with its housing placed properly, as well as with all required safety-relevant parts.   |
|   | All the specifications in this manual refer to the hardware and software versions documented in it.   |
|  | For more detailed indications and explanations on project planning, installation, and parameter configuration, please consult manual MN04020001E<br>The complete documentation for the M-Max Series of frequency converters is stored electronically on a CD-ROM. This CD-ROM is part of the scope of supply.<br>Additional information on the series described here can be found on the Internet under: <a href="http://www.eaton.com/M-Max">www.eaton.com/M-Max</a> |

## Rated operational data on the nameplate

The device-specific rated operational data for M-Max Series adjustable frequency drives is shown on the nameplate on the device's side and on the back of the control signal terminal cover.

The inscription of the nameplates has the following meaning (example):

**Table 1: Nameplate Inscriptions**

| Label   | Meaning  |
|---|--|
| MMX34AA3D3F0-0  | Part no.:<br>MMX = M-Max Series adjustable frequency drive<br>3 = Three-phase power connection<br>4 = 400V voltage category<br>AA = Instance (Software version A and alphanumeric display)<br>3D3 = 3.3A rated current (3-decimal-3)<br>F = Integrated radio interference suppression filter<br>0 = IP20 protection class<br>0 = No integrated optional assembly |
| Input   | Power connection rating:<br>Three-phase AC voltage ( $U_e$ 3~ AC),<br>380 – 480V voltage, 50/60 Hz frequency, input phase current (4.0A)   |
| Output  | Load side (motor) rating:<br>Three-phase AC voltage (0 – $U_e$ ), output phase current (3.3A), output frequency (0 – 320 Hz)   |
| Power   | Assigned motor rating<br>1.1 kW at 400 V/1.5 hp at 460V for a four-pole internally cooled or surface-cooled three-phase asynchronous motor<br>(1500 rpm at 50 Hz/ 1800 rpm at 60 Hz)   |
| S/N   | Serial number  |
|  | Adjustable frequency drive is an electrical apparatus.<br>Read the manual (in this case MN04020001E) before making any electrical connections and commissioning.   |
| IP20/Open Type  | Degree of protection of the enclosure: IP20,<br>UL® (cUL®) Open type   |
| 40W09   | Manufacturing date<br>Calendar week 40 of the year 2009  |

## Mains voltages

The given rated operational voltages in **Table 2** are based on the standardized rated values in centrally earthed star networks.

In ring-type networks (e.g., Europe) the rated voltage corresponds the value of the consumer networks (e.g., 230V, 400V) at the utility company's transfer point.

In star-type mains (e.g., North America) the rated voltage at the utility company's transfer point is higher than in the consumer network. For example: 120V → 115V, 240V → 230V, 480V → 460V.

**Table 2: General Rated Operational Data**

| Technical data   | Unit           | Value   |
|--|----------------|---|
| <b>General</b>   |                |   |
| Standards and regulations  |                | EMC: IEC/EN 61800-3,<br>Safety: IEC/EN 61800-5, UL 508C   |
| Certifications and manufacturer's declarations on conformity               |                | EMC: CE, CB, c-Tick<br>Safety: CE, CB, UL, cUL, phenum rated  |
| Production quality   |                | RoHS, ISO® 9001   |
| Climatic proofing  |                | < 95%, average relative humidity, noncondensing (EN 50178)  |
| Air quality  |                |   |
| Chemical vapors  |                | IEC 721-3-3: Device in operation, Class 3C2   |
| Mechanical particles   |                | IEC 721-3-3: Device in operation, Class 3S2   |
| Ambient temperature  |                |   |
| Operation  | °C             | -10 to +50 ①  |
| Storage  | °C             | -40 to +70  |
| Installation altitude  | H              | 0 – 1000m above sea level, over 1000m with 1% power reduction per 100m, maximum 2000m, at maximum +50°C ambient temperature. 2000m maximum for corner grounded device, 4500m for non-corner grounded device |
| Mounting position  |                | Vertical (± 90 degrees lateral rotation)  |
| Protection type  |                | IP20  |
| Busbar tag shroud  |                | BGV A3 (VBG4, finger and back-of-hand safe)   |
| Oversoltage category/degree of pollution                                   |                | —   |
| Mechanical shock resistance  |                | IEC 68-2-27<br>Storage and transport: 15g, 11 ms (in the packaging)<br>UPS drop test (for applicable UPS weights)   |
| Vibration  |                | EN 60068-2-6<br>3 – 150 Hz, oscillation amplitude 1 mm (Peak) at 3 – 15.8 Hz, maximum acceleration amplitude 1g at 15.8 – 150 Hz  |
| Emitted interference with internal EMC filter (maximum motor cable length) |                | C2: Class A in 1st environment (residential area with commercial utilization)<br>C3: Class A in 2nd environment (Industrial)  |
| MMX11  |                | C2 (5m), C3 (30m)   |
| MMX12, MMX32   |                | C2 (5m), C3 (30m)   |
| MMX34  |                | C2 (5m), C3 (30m)   |
| <b>Power Section</b>   |                |   |
| Rated operational voltage  |                | at 50/60 Hz ±10 %   |
| MMX11  | U <sub>e</sub> | 1 AC 115V (110V – 15% ... 120V + 10%)   |
| MMX12  | U <sub>e</sub> | 1 AC 230V (208V – 15% ... 240V + 10%)   |
| MMX32  | U <sub>e</sub> | 3 AC 230V (208V – 15% ... 240V + 10%)   |
| MMX34  | U <sub>e</sub> | 3 AC 400V (380V – 15% ... 480V + 10%)   |

**Table 2: General Rated Operational Data (continued)**

| Technical data   | Unit      | Value   |
|--|-----------|---|
| <b>Power Section (continued)</b>                               |           |   |
| Mains network configuration (AC power supply network)          |           | Center-point grounded star network (TN-S network)<br>Phase grounded AC networks are not permitted.                          |
| Mains switch-on frequency                                      |           | Maximum one time per minute   |
| Mains current  | THD       | >120%   |
| Short-circuit current  |           | max. < 50 kA  |
| Mains frequency  | $f_{LN}$  | 50/60 Hz (45 – 66 Hz $\pm$ 0%)  |
| Pulse frequency (switching frequency of the inverter)          | $f_{PWM}$ | 1 kHz – 16 kHz (WE: 6 kHz) <sup>①</sup>   |
| Operating mode   |           | V/Hz-characteristic curve control (WE), sensorless vector control (open loop)   |
| Output voltage   | $U_2$     | 3 AC 230V (MMX11), 3 AC $U_e$ (MMX12, MMX32, MMX34)   |
| Output frequency   | $f_2$     | 0 – 320 Hz (WE: 0 – 50 Hz)  |
| Frequency resolution (set point value)                         | Hz        | 0.01  |
| Rated operational current                                      | $I_e$     | 100% continuous current at maximum +50°C ambient temperature  |
| Overload current   |           | 150% for 60s every 600s   |
| Starting current   |           | 200% for 2s every 20s   |
| Braking torque   |           | Maximum 30% $M_N$ for all sizes<br>up to maximum 100% $M_N$ only as of size MMX34...4D3... with external braking resistance |
| <b>Control Section</b>   |           |   |
| Control voltage (output)                                       | V DC      | 24, max. 50 mA  |
| Reference voltage (output)                                     | V DC      | 10, max. 10 mA  |
| Input, digital, parameter definable                            |           | 6 x, max. +30 Vdc, $R_i > 12k$ ohm  |
| Permitted residual ripple with external control voltage (+24V) |           | Max. 5% $\Delta U_a/U_a$  |
| Input, analog, parameter definable                             |           | 2 x 0 – +10 Vdc, $R_i > 200k$ ohm / 0 (4) – 20 mA, $R_B \sim 200$ ohm   |
| Resolution   | Bit       | 10  |
| Output, analog, parameter definable                            |           | 1 x 0 – 10 Vdc, max. 10 mA  |
| Resolution   | Bit       | 10  |
| Output, digital, parameter definable                           |           | 1 x Transistor, max. 48 Vdc, max. 50 mA   |
| Output relay, parameter definable                              |           | 1 x N/O 250 Vac maximum 2A/250 Vdc, maximum 0.4A  |
| Output relay, parameter definable                              |           | 1 x C/O 250 Vac maximum 2A/250 Vdc, maximum 0.4A  |
| Serial interface   |           | RS-485/Modbus <sup>®</sup> RTU  |

<sup>①</sup> With MMX34AA014F0-0, the maximum permitted ambient temperature is limited to +40 °C and the maximum pulse frequency ( $f_{PWM}$ ) to 4 kHz.



February 2010

## Technical Data

**Table 3: Technical Data**

| Part Number | Rated Operational Current | Overload Current (150%) | Assigned Motor Rating |                  |                 |                  | Installation Size |
|-------------|---------------------------|-------------------------|-----------------------|------------------|-----------------|------------------|-------------------|
|             | $I_e$                     | $I_{e150}$              | P (230V, 50 Hz)       |                  | P (230V, 60 Hz) |                  |                   |
|             | [A]                       | [A]                     | [kW]                  | [A] <sup>①</sup> | [hp]            | [A] <sup>①</sup> |                   |

**Power Connection Voltage: 1 AC 115V, 50/60 Hz (94 – 132V ± 0%, 45 – 66 Hz ± 0%)**

|                |     |     |      |     |                  |                  |     |
|----------------|-----|-----|------|-----|------------------|------------------|-----|
| MMX11AA1D7.... | 1.7 | 2.6 | 0.25 | 1.4 | 1/3 <sup>②</sup> | 1.5 <sup>②</sup> | FS2 |
| MMX11AA2D4.... | 2.4 | 3.6 | 0.37 | 2.0 | 1/2              | 2.2              | FS2 |
| MMX11AA2D8.... | 2.8 | 4.2 | 0.55 | 2.7 | 3/4              | 2.2              | FS2 |
| MMX11AA3D7.... | 3.7 | 5.6 | 0.75 | 3.2 | 1                | 3.2              | FS2 |
| MMX11AA4D8.... | 4.8 | 7.2 | 1.10 | 4.6 | 1-1/2            | 4.2              | FS3 |

**Power Connection Voltage: 1 AC 230V, 50/60 Hz (177 – 264V ± 0%, 45 – 66 Hz ± 0%)**

|                |     |      |      |     |                  |                  |     |
|----------------|-----|------|------|-----|------------------|------------------|-----|
| MMX12AA1D7.... | 1.7 | 2.6  | 0.25 | 1.4 | 1/3 <sup>②</sup> | 1.5 <sup>②</sup> | FS1 |
| MMX12AA2D4.... | 2.4 | 3.6  | 0.37 | 2.0 | 1/2              | 2.2              | FS1 |
| MMX12AA2D8.... | 2.8 | 4.2  | 0.55 | 2.7 | 3/4              | 2.2              | FS1 |
| MMX12AA3D7.... | 3.7 | 5.6  | 0.75 | 3.2 | 1                | 3.2              | FS2 |
| MMX12AA4D8.... | 4.8 | 7.2  | 1.10 | 4.6 | 1-1/2            | 4.2              | FS2 |
| MMX12AA7D0.... | 7.0 | 10.5 | 1.50 | 6.3 | 2                | 6.8              | FS2 |
| MMX12AA9D6.... | 9.6 | 14.4 | 2.20 | 8.7 | 3                | 9.6              | FS3 |

**Power Connection Voltage: 3AC 230V, 50/60 Hz (177 – 264V ± 0%, 45 – 66 Hz ± 0%)**

|                |      |      |      |     |                  |                  |     |
|----------------|------|------|------|-----|------------------|------------------|-----|
| MMX32AA1D7.... | 1.7  | 2.6  | 0.25 | 1.4 | 1/3 <sup>②</sup> | 1.5 <sup>②</sup> | FS1 |
| MMX32AA2D4.... | 2.4  | 3.6  | 0.37 | 2.0 | 1/2              | 2.2              | FS1 |
| MMX32AA2D8.... | 2.8  | 4.2  | 0.55 | 2.7 | 3/4              | 2.2              | FS1 |
| MMX32AA3D7.... | 3.7  | 5.6  | 0.75 | 3.2 | 1                | 3.2              | FS2 |
| MMX32AA4D8.... | 4.8  | 7.2  | 1.10 | 4.6 | 1-1/2            | 4.2              | FS2 |
| MMX32AA7D0.... | 7.0  | 10.5 | 1.50 | 6.3 | 2                | 6.8              | FS2 |
| MMX32AA011.... | 11.0 | 14.4 | 2.20 | 8.7 | 3                | 9.6              | FS3 |

<sup>①</sup> Rated motor currents for normal four-pole internally cooled and surface-cooled three-phase asynchronous motors (1500 rpm at 50 Hz, 1800 rpm at 60 Hz).

<sup>②</sup> Calculated motor rating (no normalized value). The mains voltage of 115V is raised to 230V (output voltage) through an internal voltage double connection.

**Table 3: Technical Data (continued)**

| Part Number | Rated Operational Current | Overload Current (150%) | Assigned Motor Rating |                  |                 |                  | Installation Size |
|-------------|---------------------------|-------------------------|-----------------------|------------------|-----------------|------------------|-------------------|
|             | $I_e$                     | $I_{e150}$              | P (230V, 50 Hz)       |                  | P (230V, 60 Hz) |                  |                   |
|             | [A]                       | [A]                     | [kW]                  | [A] <sup>①</sup> | [hp]            | [A] <sup>①</sup> |                   |

**Power Connection Voltage: 3 AC 400V/460V, 50/60 Hz (323 – 528V ± 0%, 45 – 66 Hz ± 0%)**

|                |      |      |                   |                     |                 |     |     |
|----------------|------|------|-------------------|---------------------|-----------------|-----|-----|
| MMX34AA1D3.... | 1.3  | 2.0  | 0.37              | 1.1                 | 1/2             | 1.1 | FS1 |
| MMX34AA1D9.... | 1.9  | 2.9  | 0.55              | 1.5                 | 3/4             | 1.6 | FS1 |
| MMX34AA2D4.... | 2.4  | 3.6  | 0.75              | 1.9                 | 1               | 2.1 | FS1 |
| MMX34AA3D3.... | 3.3  | 5.0  | 1.10              | 2.6                 | 1-1/2           | 3   | FS2 |
| MMX34AA4D3.... | 4.3  | 6.5  | 1.50              | 3.6                 | 2               | 3.4 | FS2 |
| MMX34AA5D6.... | 5.6  | 8.4  | 2.20              | 5.0                 | 3               | 4.8 | FS2 |
| MMX34AA7D6.... | 7.6  | 11.4 | 3.00              | 6.6                 | 4               | 7.6 | FS3 |
| MMX34AA9D0.... | 9.0  | 13.5 | 4.00              | 8.5                 | 5.5             | 7.6 | FS3 |
| MMX34AA012.... | 12.0 | 18.0 | 5.50              | 11.3                | 7-1/2           | 11  | FS3 |
| MMX34AA014.... | 14.0 | 21.0 | 7.50 <sup>②</sup> | (15.2) <sup>③</sup> | 10 <sup>②</sup> | 14  | FS3 |

① Rated motor currents for normal four-pole internally-cooled and surface-cooled three-phase asynchronous motors (1500 rpm at 50 Hz, 1800 rpm at 60 Hz).

② Allocated motor output at a maximum ambient temperature of +40°C and a maximum pulse frequency of 4 kHz.

③ Operation with reduced load torque (about -10% MN).

**Control signal terminals**

The control section, with the corresponding control signal terminals, is shown below.

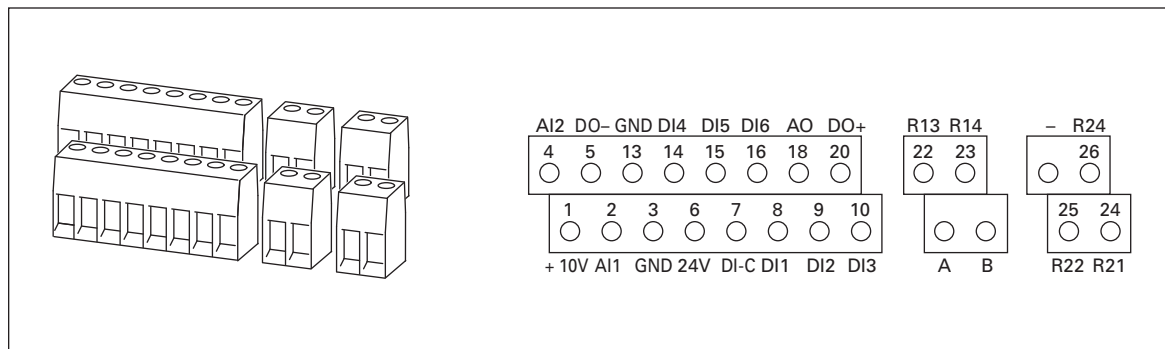

**Figure 3: Schematic Arrangement and Designation of Control Signal Terminals**

**Table 4: Cable Cross Section (Cu): 0.5 – 1.5 mm<sup>2</sup>**

| Terminal Blocks | Signal | Factory Setting                                 | Description   |
|-----------------|--------|---|---|
| 1               | +10V   | Output nominal voltage                          | —<br>Maximum load 10 mA, reference potential GND  |
| 2               | AI1    | Analog signal input 1                           | Frequency reference value ①<br>0 – +10V (R <sub>i</sub> > 200k ohms)<br>0/4 – 20 mA (R <sub>B</sub> = 200 ohms)<br>Selectable with microswitch S2 |
| 3               | GND    | Reference potential                             | —<br>0V   |
| 6               | 24V    | Control voltage for DI1 – DI6, output (+24V)    | —<br>Maximum load 50 mA, reference potential GND  |
| 7               | DI-C   | Reference potential of digital inputs DI1 – DI6 | LOGIC– (GND)<br>Selectable through microswitch LOGIC –/+  |
| 8               | DI1    | Digital input 1                                 | FWD start enable, forward ①<br>0 – +30V (R <sub>i</sub> > 12k ohms)   |
| 9               | DI2    | Digital input 2                                 | REV start enable, reverse ①<br>0 – +30 (R <sub>i</sub> > 12k ohms)  |
| 10              | DI3    | Digital input 3                                 | Fixed frequency B0<br>0 – +30V (R <sub>i</sub> > 12k ohms)  |
| 4               | AI2    | Analog input 2                                  | PI actual value ①<br>0 – +10V (R <sub>i</sub> > 200k ohms)<br>0/4 – 20 mA (R <sub>B</sub> = 200 ohms)<br>Selectable through microswitch S3        |
| 5               | GND    | Reference potential                             | —<br>0V   |
| 13              | DO–    | Digital output                                  | Active = READY ①<br>Transistor, max. 50 mA, terminal 20 supply voltage  |
| 14              | DI4    | Digital input 4                                 | Fixed frequency B1<br>0 – +30V (R <sub>i</sub> = 12k ohms)  |
| 15              | DI5    | Digital input 5                                 | Error acknowledgment ①<br>0 – +30V (R <sub>i</sub> = 12k ohms)  |
| 16              | DI6    | Digital input 6                                 | PI controller deactivated ①<br>0 – +30V (R <sub>i</sub> = 12k ohms)   |
| 18              | AO     | Analog output                                   | Output frequency ①<br>0 – +10V, max. 10 mA  |
| 20              | DO+    | Digital output                                  | Supply voltage, see terminal 13<br>Supply voltage for digital output DO– max. 48 Vdc, max. 50 mA  |
| A               | A      | RS-485 signal A                                 | BUS-Communication<br>Modbus RTU   |
| B               | B      | RS-485 signal B                                 | BUS-Communication<br>Modbus RTU   |
| 22              | R13    | Relay 1, normally open contact                  | Active = RUN ①<br>Maximum switching load: 250 Vac/2A or 250 Vdc/0.4A  |
| 23              | R14    | Relay 1, normally open contact                  | Active = RUN ①<br>Maximum switching load: 250 Vac/2A or 250 Vdc/0.4A  |
| 24              | R22    | Relay 2, normally closed contact                | Active = FAULT ①<br>Maximum switching load: 250 Vac/2A or 250 Vdc/0.4A  |
| 25              | R21    | Relay 2, common contact                         | Active = FAULT ①<br>Maximum switching load: 250 Vac/2A or 250 Vdc/0.4A  |
| 26              | R24    | Relay 2, normally open contact                  | Active = FAULT ①<br>Maximum switching load: 250 Vac/2A or 250 Vdc/0.4A  |

① Programmable function (→ section “List of parameters,” Page 30).

**Block diagram**

The following diagrams show all the terminals on an M-Max Series adjustable frequency drive and their functions at the default settings.

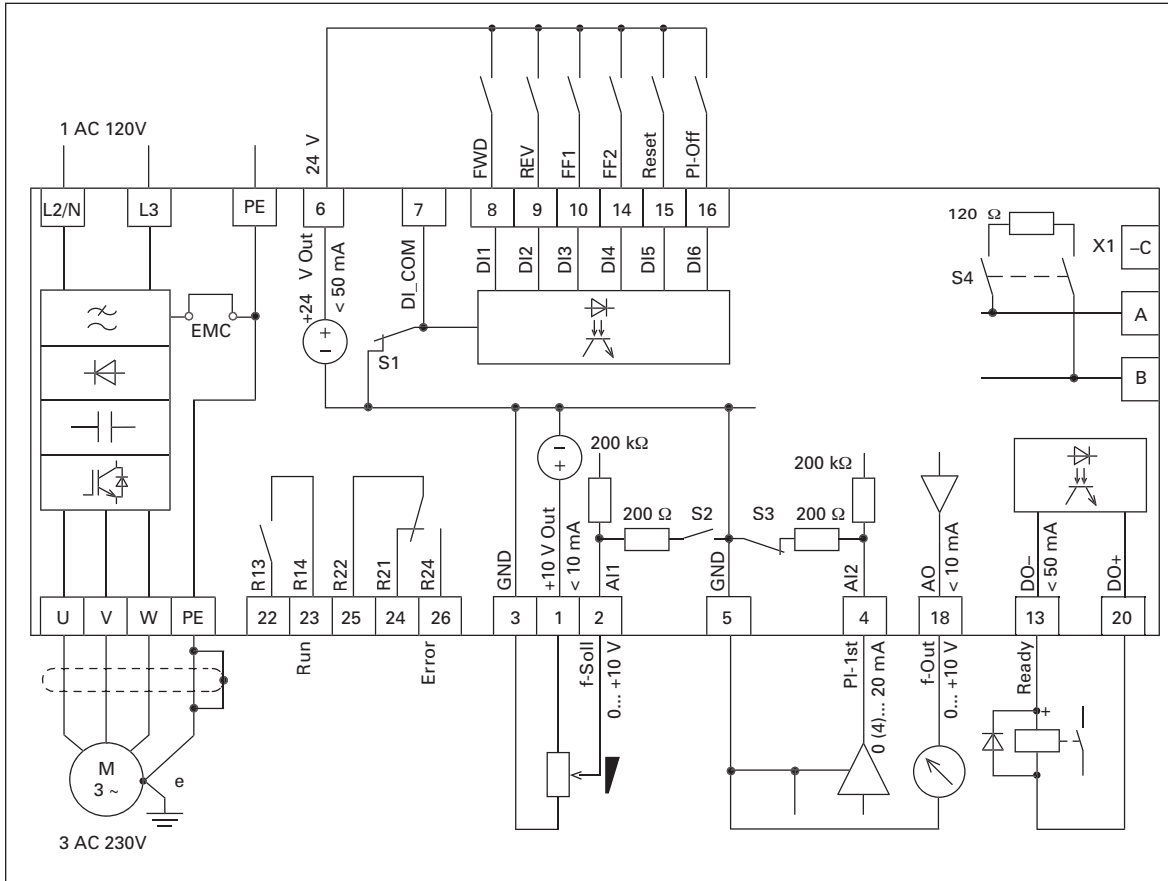

**Figure 4: Block Diagram MMX11**

**Note:** Block diagram MMX11 has a voltage doubler connection in the internal DC link.  
At a connection voltage of 1 AC 120V (115V), a motor voltage of 3 AC 230V is output.

February 2010

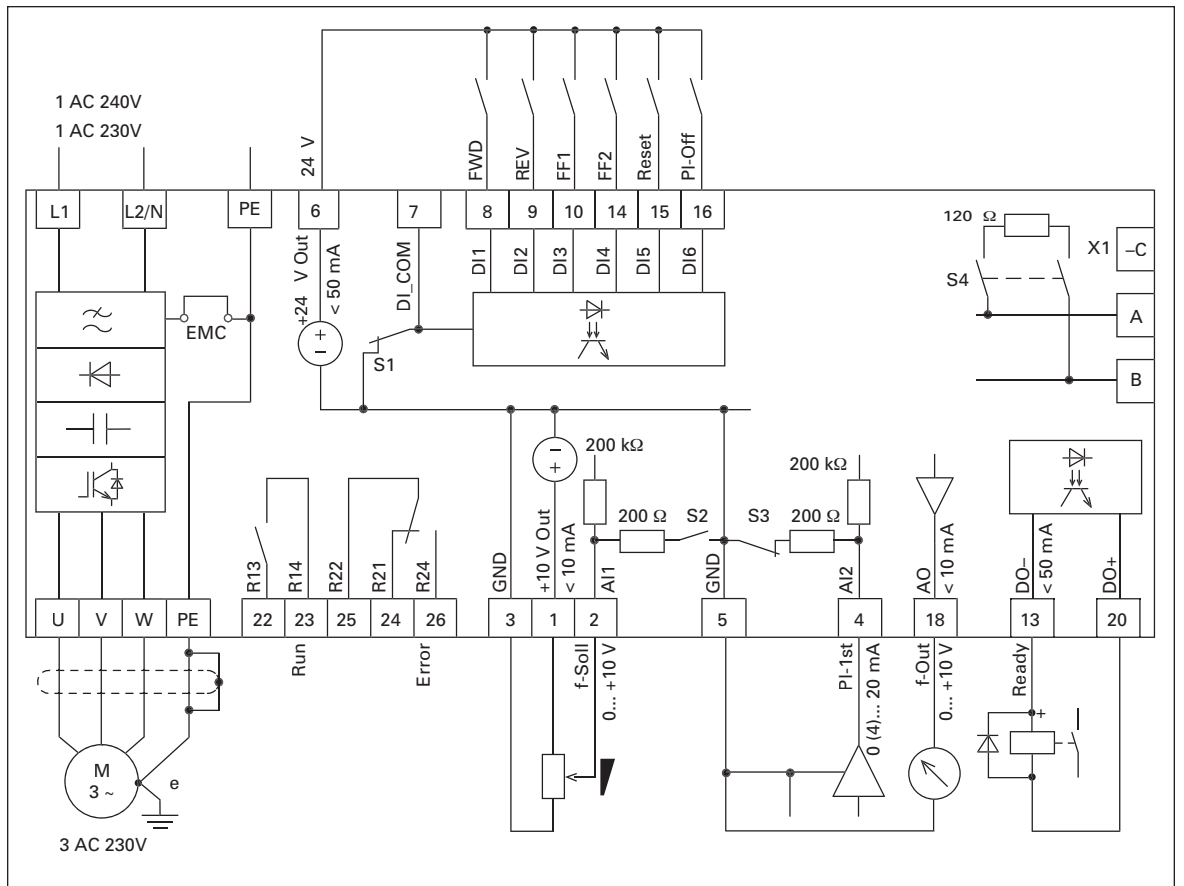

**Figure 5: MMX12 Block Diagram**

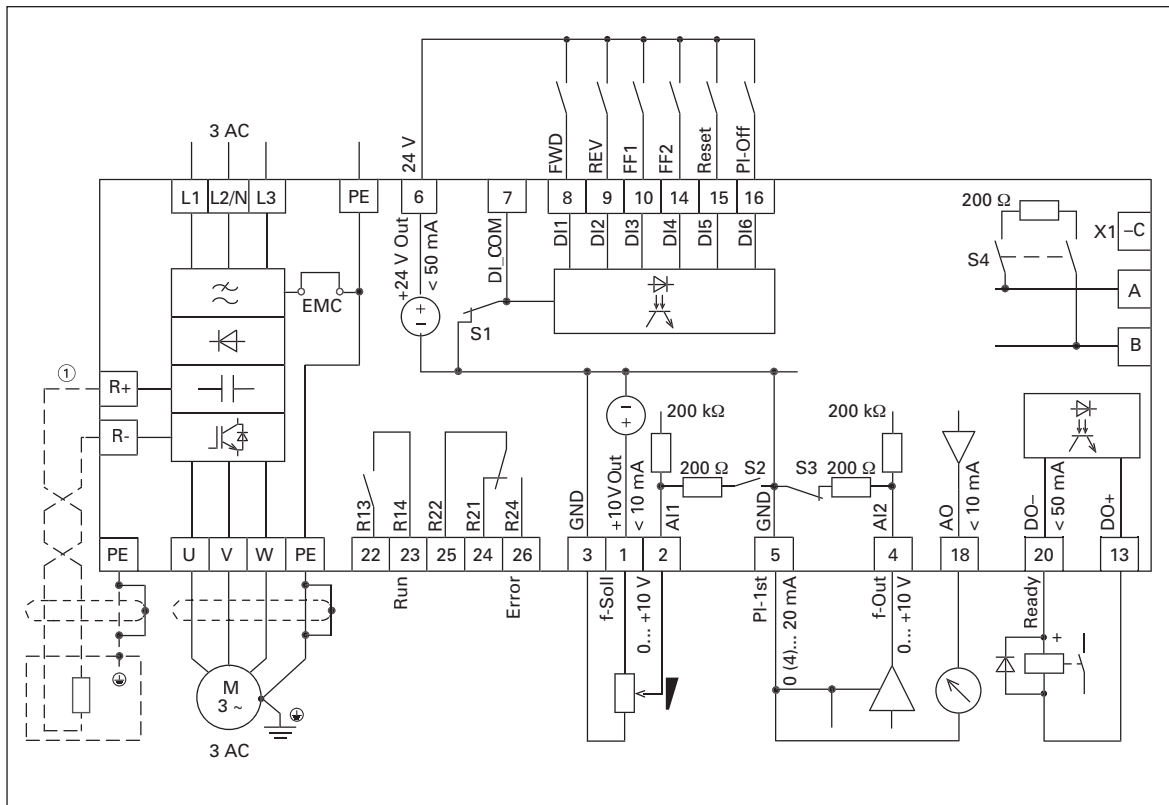

**Figure 6: Block Diagram MMX32 and MMX34**

① Connection terminals R+ and R- for external braking resistance (optional), only with MMX34...4D3..., MMX34...5D6..., MMX34...7D6..., MMX34...9D0, MMX34...012... and MMX34...014....

February 2010

## Operation

### Checklist for commissioning

Before placing the adjustable frequency drive into operation, make sure to check the following (checklist):

| No.                         | Activity  | Note |
|-----------------------------|---|------|
| 1 <input type="checkbox"/>  | Installation and wiring have been carried out in accordance with the corresponding installation instructions (→ IL04020001E).   |      |
| 2 <input type="checkbox"/>  | All wiring and line section leftovers, as well as all the tools used, have been removed from the adjustable frequency drive's proximity.  |      |
| 3 <input type="checkbox"/>  | All terminals in the power section and in the control section were tightened with the specified torque.   |      |
| 4 <input type="checkbox"/>  | The lines connected to the output terminals of the adjustable frequency drive (U/T1, V/T2, W/T3, R+, R-) are not short-circuited and are not connected to ground (PE).              |      |
| 5 <input type="checkbox"/>  | The adjustable frequency drive has been earthed properly (PE).  |      |
| 6 <input type="checkbox"/>  | All electrical terminals in the power section (L1, L2/N, L3, U/T1, V/T2, W/T3, R+, R-, PE) were implemented properly and were designed in line with the corresponding requirements. |      |
| 7 <input type="checkbox"/>  | Each single-phase of the supply voltage (L1, L2, L3) is protected with a fuse.  |      |
| 8 <input type="checkbox"/>  | The adjustable frequency drive and the motor have been adjusted for the corresponding line voltage (→ section "Rated operational data on the nameplate," <b>Page 4</b> ).           |      |
| 9 <input type="checkbox"/>  | The quality and volume of cooling air are in line with the environmental conditions required for the adjustable frequency drive.  |      |
| 10 <input type="checkbox"/> | All connected control lines comply with the corresponding stop conditions (e.g., switch in OFF position and set point value = zero).  |      |
| 11 <input type="checkbox"/> | The parameters that were preset at the factory have been checked with the list of parameters (→ section "List of parameters," <b>Page 30</b> ).                                     |      |
| 12 <input type="checkbox"/> | The effective direction of a coupled machine will allow the motor to start.   |      |
| 13 <input type="checkbox"/> | All emergency switching off functions and safety functions are in an appropriate condition.   |      |

## Hazard warnings

Please observe the following notes.

---

 **DANGER**

---

Commissioning is only to be completed by qualified technicians.

---

 **DANGER**

---

Hazardous voltage!

The safety instructions on pages iv and v must be followed.

---

 **DANGER**

---

The components in the adjustable frequency drive's power section are energized if the supply voltage (line voltage) is connected. For instance: power terminals L1, L2/N, L3, R+, R-, U/T1, V/T2, W/T3.

The control signal terminals are isolated from the line power potential.

There can be a dangerous voltage on the relay terminals (22 to 26) even if the frequency converter is not being supplied with line voltage (e.g., integration of relay contacts in control systems with 230 Vac)

---

 **DANGER**

---

The components in the frequency converter's power section remain energized up to five (5) minutes after the supply voltage has been switched off (intermediate circuit capacitor discharging time).

Pay attention to hazard warnings!



---

 **DANGER**

---

Following a shutdown (fault, line voltage off), the motor can start automatically (when the supply voltage is switched back on) if the automatic restart function has been enabled.

(→ parameter P6.13)



February 2010

---

** CAUTION**

---

Any contactors and switching devices on the power side are not to be opened during motor operation. Inching operation using the power switch is not permitted.

Contactors and switching devices (repair and maintenance switches) on the motor side are never to be opened while the motor is in operation, if the adjustable frequency drive is set to speed control operating mode (sensorless vector, P11.8 = 1).

Inching operation of the motor with contactors and switching devices in the output of the adjustable frequency drive is not permitted.

---

** CAUTION**

---

Make sure that there is no danger in starting the motor. Disconnect the driven machine if there is a danger in an incorrect operational status.

The START button is only functional if the KEYPAD operating mode is activated. The STOP button is active in all operating modes.

If motors are to be operated with frequencies higher than the standard 50 or 60 Hz, then these operating ranges must be approved by the motor manufacturer. The motors could be damaged otherwise.

## Error and Warning Messages

### Introduction

The M-Max Series adjustable frequency drive have several internal monitoring functions. When deviations from the optimal operating status are detected, faults (FAULT) and warning messages (ALARM) are differentiated between.

### Error messages

Faults can cause faulty functionality and technical defects. The inverter (adjustable frequency drive output) is automatically disabled if a fault is detected. The connected motor then runs down freely to a stop.

Error messages are shown on the display with an arrowhead ▲ under FAULT and with the error code F... (F1 = last fault, F2 = last but one fault, etc.).

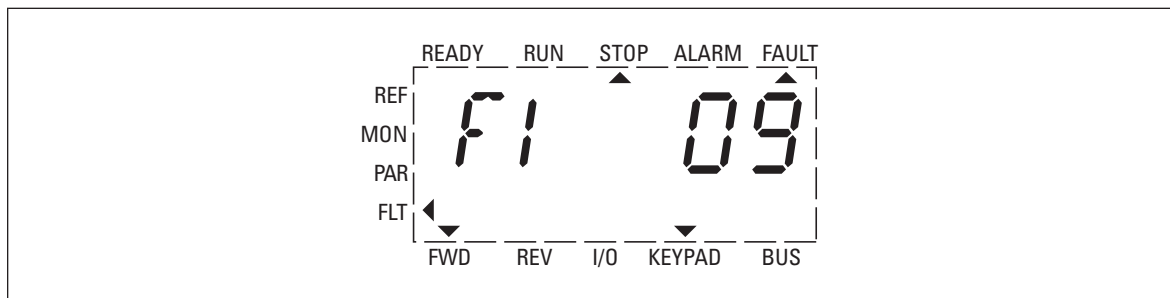

Figure 7: Error Message Example

### Acknowledge fault message (Reset)

The current fault message flashes (for example, F1 09). It can be acknowledged with the BACK/RESET key or by actuating DI5 (by default control signal terminal 15). The display automatically changes from the flashing indication through four horizontal lines (Reset) to the continuous display of the fault message. The arrow tip ▲ under FAULT goes out.

### DANGER

When a start signal is applied, the drive restarts automatically if P3.1 = 0 is set (REAF = restart after fault) and when the fault message has been acknowledged (Reset).

The current fault message indication (F1...) is cleared when the power supply is interrupted or when you press the BACK/RESET key and then the OK key (indication d...) and then the BACK/RESET key again. The indication goes out and the arrow tip ◀ flashes at menu level MON.

**Fault log (FLT)**

The last nine faults can be called up and shown in succession in the fault log (FLT).

To do this, select menu level FLT (◀). With arrow keys ^ and v you can separately call up faults F1 to F9. Each fault is saved together with the time at which it occurred: d (day), H (hour) and m (minute). To select a fault message, use arrow keys ^ and v and OK.

The content of the fault memory is cleared when the default settings are reloaded. When you press the BACK/RESET key, the menu level indication (◀) flashes and you then hold the STOP key for about 5 seconds.

→ When the default settings are loaded, all parameters are reset!

**Alarm messages**

A warning message warns of possible damages and indicates threatening faults, which can still be avoided, for example in the event of excess temperature.

Warning messages appear on the display with an arrow ▲ under ALARM and AL with the respective code number. The code numbers for faults and warning messages are identical.

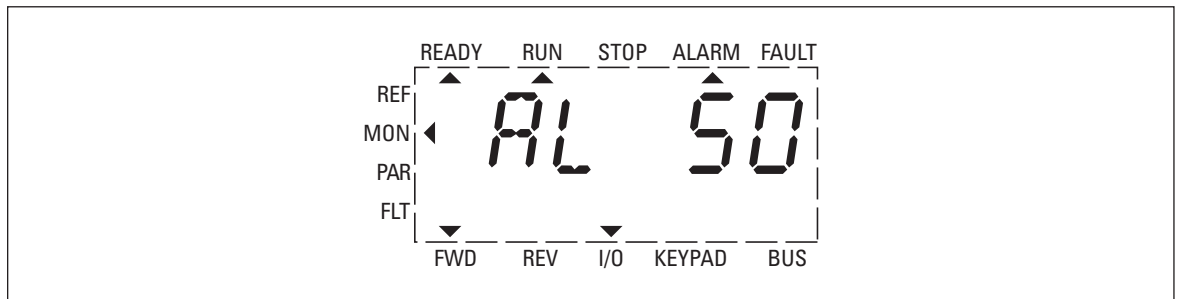

**Figure 8: Example of an Alarm Message**

→ If a warning message occurs, the adjustable frequency drive remains active (READY, RUN).

In the given example (AL 50 = current set point signal 4–20 mA interrupted), the drive stops following the absence of a reference value. If no more measures are introduced because of the warning message (e.g., a shutdown), the drive can start again automatically in the example AL 50 when the current signal returns (e.g., a contact fault in the signal line).

The alarm message (AL) is displayed alternating with the active operational display value.

**Table 5** shows the error code, the possible causes, and indicates corrective measures.

**Table 5: List of Fault Messages (F) and Warning Messages (AL)**

| Display | Designation            | Possible Cause   | Instructions  |
|---------|------------------------|--|---|
| 01      | Overcurrent            | <ul style="list-style-type: none"> <li>The adjustable frequency drive has detected an excessive current (<math>&gt; 4 \times I_N</math>) in the motor cable</li> <li>Sudden load increase</li> <li>Short circuit in motor cable</li> <li>Inadequate motor</li> </ul> | <ul style="list-style-type: none"> <li>Check the load</li> <li>Check the motor size</li> <li>Check the cable (→ parameter P6.6)</li> </ul>  |
| 02      | Overvoltage            | <ul style="list-style-type: none"> <li>The DC bus voltage has exceeded the internal safety limit</li> <li>The delay time is too short</li> <li>High overvoltage peaks in line power</li> </ul>   | Increase braking time   |
| 03      | Ground fault           | <ul style="list-style-type: none"> <li>An additional leakage current was detected when starting by means of a current measurement</li> <li>Insulation fault in the cables or in the motor</li> </ul>   | Check the motor cable and the motor   |
| 08      | System fault           | <ul style="list-style-type: none"> <li>Component fault</li> <li>Malfunction</li> </ul>   | Reset the fault and restart. If the fault occurs again, please contact your Eaton representative or call 877-ETN-CARE (386-2273).   |
| 09      | Undervoltage           | <p>The DC bus voltage is operating below voltage level.<br/>Probable cause:</p> <ul style="list-style-type: none"> <li>The supply voltage is too low</li> <li>Internal device fault</li> <li>Power failure</li> </ul>  | <ul style="list-style-type: none"> <li>If a brief power failure takes place, reset the fault and restart the adjustable frequency drive</li> <li>Check the supply voltage. If it is OK, there is an internal fault. If this is the case, please contact your Eaton representative or call 877-ETN-CARE (386-2273).</li> </ul> |
| 13      | Under-temperature      | The IGBT switch temperature is below $-10^{\circ}\text{C}$ .   | Check the ambient temperature   |
| 14      | Over-temperature       | The IGBT switch temperature is above $120^{\circ}\text{C}$ . An excessive temperature warning is issued if the IGBT switch temperature goes above $110^{\circ}\text{C}$ .  | <ul style="list-style-type: none"> <li>Make sure that there is an unobstructed flow of cooling air</li> <li>Check the ambient temperature</li> <li>Make sure that the switching frequency is not too high in relation to the ambient temperature and to the motor load</li> </ul>   |
| 15      | Stall protection       | The motor blocking protection mechanism has been triggered.  | Check the motor   |
| 16      | Motor over-temperature | The adjustable frequency drive's motor temperature model has detected motor overheating. The motor is overloaded.  | Decrease the motor load. If the motor is not overloaded, check the temperature model parameter.   |
| 22      | EEPROM checksum error  | <ul style="list-style-type: none"> <li>Error when storing parameters</li> <li>Malfunction</li> <li>Component fault</li> <li>Error in microprocessor monitoring</li> </ul>  | Please contact your Eaton representative or call 877-ETN-CARE (386-2273).   |
| 25      | Watchdog               | <ul style="list-style-type: none"> <li>Error in microprocessor monitoring</li> <li>Malfunction</li> <li>Component fault</li> </ul>   | Reset the fault and restart. If the fault occurs again, please contact your Eaton representative or call 877-ETN-CARE (386-2273).   |

**Table 5: List of Fault Messages (F) and Warning Messages (AL) (continued)**

| Display | Designation                  | Possible Cause   | Instructions   |
|---------|------------------------------|--|--|
| 34      | Internal communication error | Environment interferences or faulty hardware   | If the fault occurs again, please contact your Eaton representative or call 877-ETN-CARE (386-2273).   |
| 35      | Application error            | The application is not working.  | Please contact your Eaton representative or call 877-ETN-CARE (386-2273).  |
| 50      | 4 mA fault (Analog input)    | Selected signal range: 4 – 20 mA<br>→ parameter P2.1<br>• Current less than 4 mA or voltage below 2V<br>• Signal line interrupted<br>• The signal source is faulty | Check the analog input's current source and circuit.   |
| 51      | External fault               | Error message on digital input. The digital input was programmed as an input for external error messages. The input is active.                                     | <ul style="list-style-type: none"> <li>• Check the programming and check the device indicated by the error message</li> <li>• Check the cabling for the respective device as well</li> </ul> |
| 53      | Field bus error              | The communication link between the master device and the drive's field bus has been interrupted.   | Check the installation. If the installation is OK, please contact your Eaton representative or call 877-ETN-CARE (386-2273).   |
| 54      | Slot fault                   | Connection not good  | Check connection between API board and fieldbus board  |

## Parameters

### Control unit

The following figure shows and indicates the elements of the M-Max's Series integrated control unit.

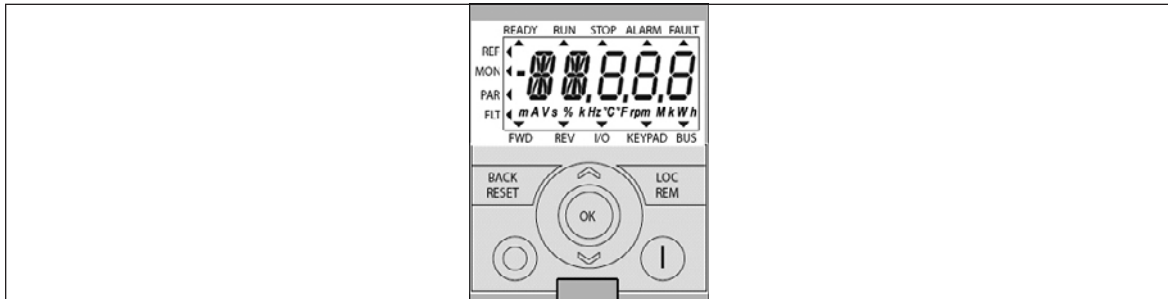
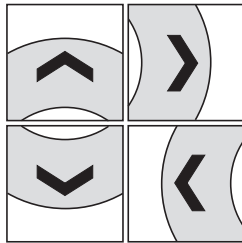

Figure 9: View: Control Unit With LCD Display, Function Keys, and Interface

Table 6: Control Unit Elements

| Operating Unit Element | Explanation  | Operating Unit Element | Explanation   |
|------------------------|--|------------------------|---|
|                        | <ul style="list-style-type: none"> <li>Backlit liquid crystal display (LCD)</li> <li>Plain text with alphanumeric characters</li> </ul>              |                        | <ul style="list-style-type: none"> <li>Select function and parameter</li> <li>Reduce numerical value</li> </ul>   |
|                        | <ul style="list-style-type: none"> <li>Acknowledge fault message (Reset)</li> <li>Activates the selection for the menu levels (◀ flashes)</li> </ul> |                        | <ul style="list-style-type: none"> <li>Switch to individual parameter groups (... S4.1 - P1.1 - P2.1 - P3.1 ...)</li> <li>Select individual digits in multi-digit display</li> </ul>  |
|                        | Switch between the different control levels (I/O – KEYPAD – BUS)   |                        |   |
|                        | <ul style="list-style-type: none"> <li>Select function and parameter</li> <li>Increase numerical value</li> </ul>                                    |                        | <ul style="list-style-type: none"> <li>Stops the running motor (P6.16)</li> <li>With the menu level active (◀ flashing) you can load the default settings (press and hold the key for five seconds). This clears the fault memory (FLT).</li> </ul> |
|                        | <ul style="list-style-type: none"> <li>Confirm and activate selection (store)</li> <li>Lock display</li> </ul>                                       |                        | Motor start with selected direction of rotation (only active in KEYPAD control level)   |
|                        |  |                        | Interface for communication (Option: MMX-COM-PC)  |

February 2010



Actuating the arrow keys causes the active value to increase or decrease the parameter number or the function by one unit.

If you hold one of the two arrow keys pressed, the respective units increase or decrease automatically.

## Display unit

The following shows the display unit (LCD display with all display elements)

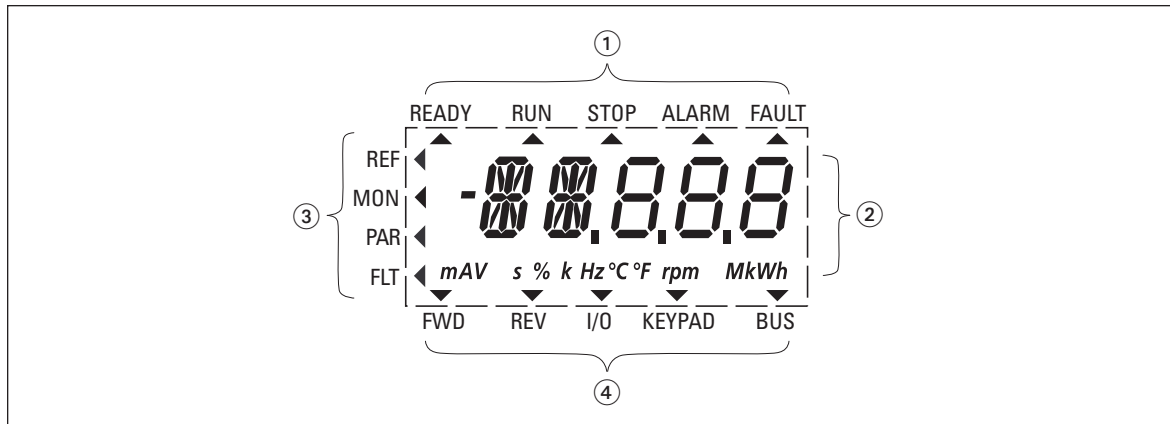

**Figure 10: LCD Display (Areas)**

The display unit consists of a backlit liquid crystal display (LCD). It is divided into four areas:

**Table 7: Areas of the LCD Display**

| Area | Description   |
|------|---|
| ①    | <p>Status display</p> <p>The arrowheads (▲) on the top border show information regarding the drive:</p> <ul style="list-style-type: none"> <li>• READY = Ready to start</li> <li>• RUN = Operating notification</li> <li>• STOP = Stop, stop command activated</li> <li>• ALARM = Alarm message activated</li> <li>• FAULT = The drive has been stopped due to an error message.</li> </ul>   |
| ②    | <p>Plain text display</p> <p>Two 14- and three 7-segment blocks for displaying:</p> <ul style="list-style-type: none"> <li>• AL = Alarm message</li> <li>• F = Error messages</li> <li>• M = Measurement value (operating data)</li> <li>• P = Parameter numbers</li> <li>• S = System parameter</li> <li>• - = Anticlockwise field of rotation (REV)</li> </ul> <p>The respective units of measurement are displayed in the bottom line.</p> |
| ③    | <p>Menu level</p> <p>The arrowhead (◀) shows the selected main menu:</p> <ul style="list-style-type: none"> <li>• REF = Set point input (Reference)</li> <li>• MON = Operational data indicator (Monitor)</li> <li>• PAR = Parameter levels</li> <li>• FLT = Fault log (Fault)</li> </ul>   |
| ④    | <p>Control commands</p> <p>The arrowhead (▼) points to the selected rotating field direction and the active control level:</p> <ul style="list-style-type: none"> <li>• FWD = Clockwise rotating field (Forward Run)</li> <li>• REV = Counterclockwise rotating field (Reverse Run)</li> <li>• I/O = Via control terminals (Input/Output)</li> <li>• KEYPAD = Via control unit</li> <li>• BUS = Via field bus (interface)</li> </ul>          |



**General information on menu navigation**

By applying the specified supply voltage to the connection terminal L2/N and L3 (MMX11), L1 and L2/N (MMX12) or L1, L2/N and L3 (MMX32, MMX34), the adjustable frequency drive automatically runs the following functions:

- The lighting of the LCD display is switched on and all segments are actuated briefly.
- After the self-test, the top status line of the LCD display indicates that the device is ready to start and proper operation by an arrow ▲ under READY. The arrow under STOP indicates that there is no start command (FWD or REV).
- The arrow ▼ in the bottom status line shows the actuation via control signal terminals with the factory setting on I/O Control (Control Input/Output). The arrow over FWD (Forward) indicates the basic rotational direction (phase sequence for a clockwise rotating field) on the output terminals U/T1, V/T2 and W/T3).
- Display for the operating data M1.1 and 0.00 Hz (output frequency) in automatic alternating sequence. The arrow ◀ in the left-hand status line indicates menu level MON (Monitor = Operating data display).

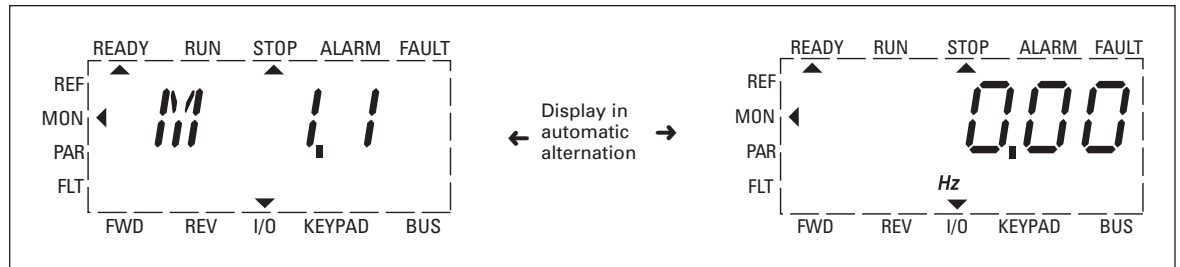

**Figure 11: Operational Data Indicator (Operational)**

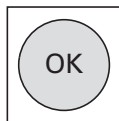

By actuating the OK button, you can set the alternating display mode to stay on the output frequency (0.00 Hz).









### Setting parameters

The following table shows an example of how you can select and set parameters.

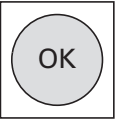
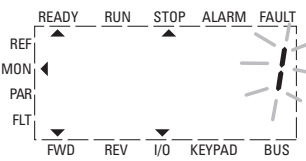
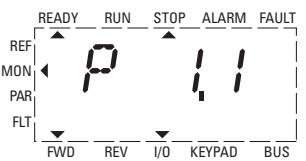
**Table 8: LCD Display in Operation**

| Sequence | Commands     | Display   | Description   |
|----------|--------------|---|---|
| 0        |              |   | <p>Measured value 1.1<br/>The display changes automatically with the value of the output frequency 0.00 Hz (at STOP).</p>   |
| 1        | <br><br><br> |   | <p>By actuating the BACK/RESET button, you activate the menu level (arrow flashes).</p> <p>You can select the individual main menus with the two arrow keys (closed circuit):</p> <ul style="list-style-type: none"> <li>• REF = Set point input (Reference)</li> <li>• MON = Operational data indicator (Monitor)</li> <li>• PAR = Parameter levels</li> <li>• FLT = Fault log (FAULT)</li> </ul> <p>Use the OK button to open the selected main menu.</p> |
| 2        |              | <p style="text-align: center;">↓</p> <p style="text-align: center;">Display in automatic alternation</p> <p style="text-align: center;">↑</p> | <p>The numerical first value is always shown from the selected main menu.<br/>Example: Main menu PAR, Parameter P1.1<br/>The display automatically switches between the parameter number and the defined value.</p> <p>Use the OK button to activate the selected parameter.<br/>The value (1) flashes.</p>   |

**Table 8: LCD Display in Operation (continued)**

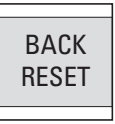
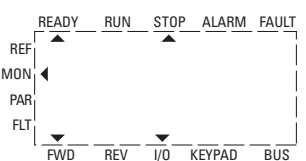
| Sequence | Commands  | Display   | Description   |
|----------|---|---|---|
| 3        | <br><br> | <br>    | <p>If the parameter value is flashing, you can use the two arrow keys to change the value within the permitted range.</p> <p>The selected value is confirmed with the OK button. The display now changes automatically between the new value and the respective parameter number.</p> |
| 4        | <br>  | <br> | <p>The other parameters in the main menu PAR can be selected with the two arrow keys (closed circuit, Example: Factory setting).</p>    |
| 5        |    |    | <p>By actuating the BACK/RESET button, you exit main menu PAR (arrow flashes, see sequence 1)</p>   |



All settings are stored automatically by actuating the OK button.



Parameters marked in column "Access right RUN" with ✓ can be changed during operation (RUN mode).

### Parameter menu (PAR)

You have access to all M-Max Series parameters in the parameter menu (PAR) (see "List of parameters" on **Page 30**).

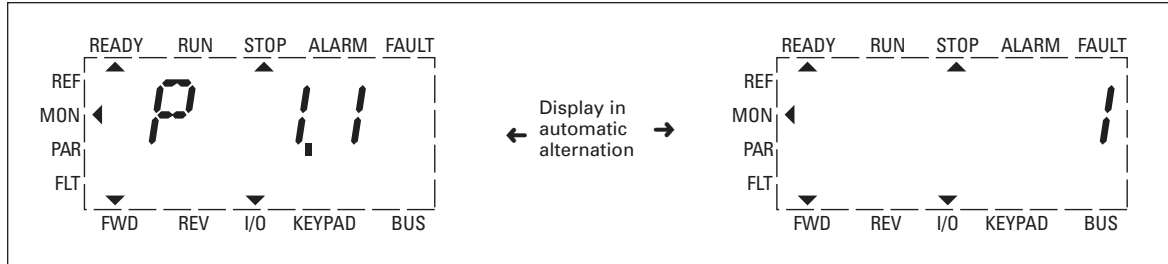

**Figure 12: Parameter Menu (P1.1 = 1, Quick-Configuration)**

- The parameter menu always starts with parameter P1.1. With P1.1 = 1 the quick start wizard starts to guide you through the procedure. Here you individually confirm a set number of parameters (see A in **Figure 13**).
- To get free access to all parameters, select P1.1 = 0 (see B in **Figure 13**).

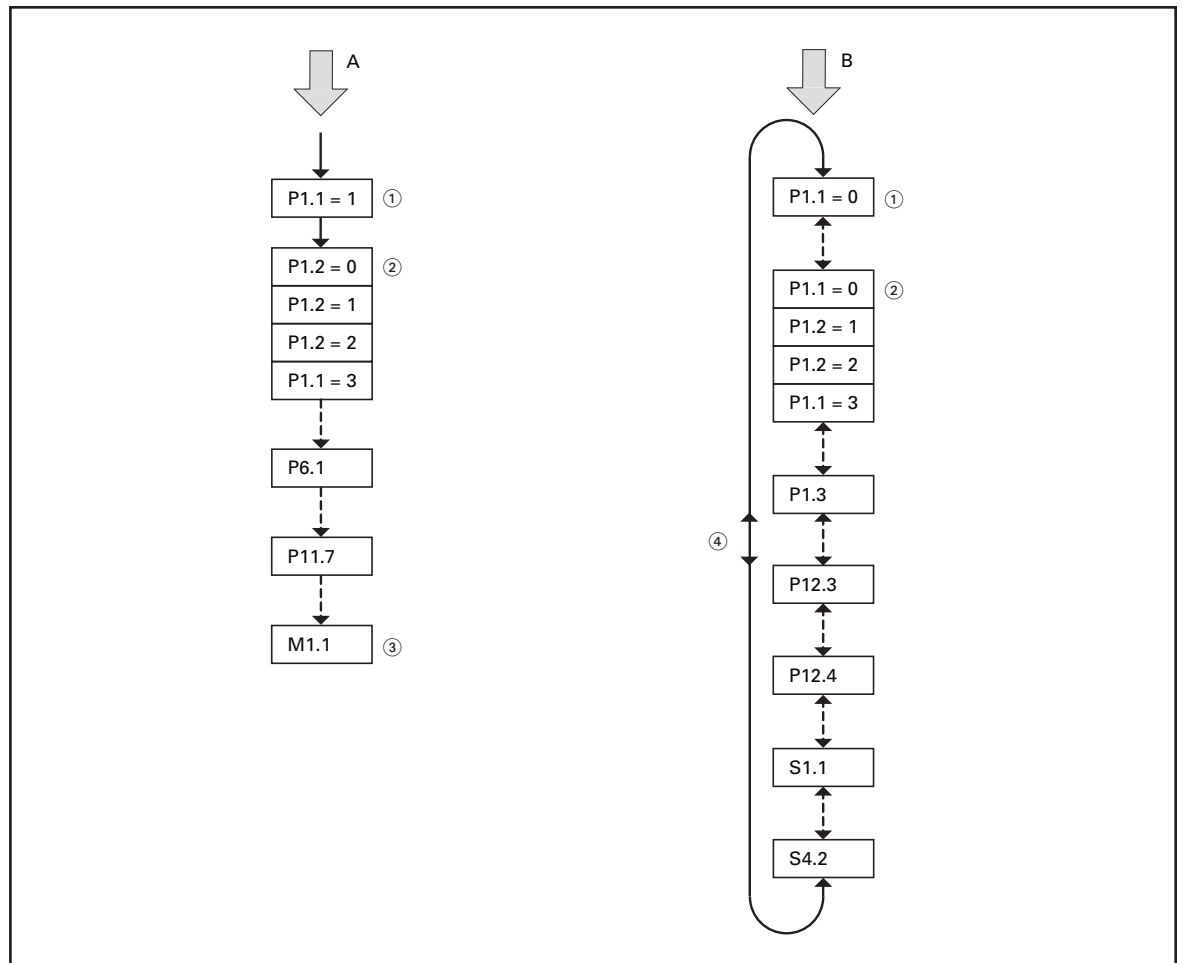

**Figure 13: Schematic Representation of Parameter Access**

- A. Access and selected parameters with the quick-start assistant
  - B. Free access to all parameters
- ① Parameter range selection  
 P1.1 = 1 (Factory setting)  
 The quick-start assistant guides you to the selected parameters (pre-defined parameter change).  
 P1.1 = 0 allows access to all parameters (free parameter selection).
  - ② Selection of pre-defined parameter values for various applications (see **Table 10** on **Page 32**).  
 P1.2 = 0: Basic, no preliminary setting  
 P1.2 = 1: Pump drive  
 P1.2 = 2: Fan drive  
 P1.2 = 3: Feed unit (high load)
  - ③ Conclusion of the quick-configuration and automatic switch to the frequency display. Selecting the PAR menu level again allows the free selection of the selected parameters of the quick-configuration and the system parameter (S) now.
  - ④ Free selection of all parameters (P1.1 = 0) with the two arrow keys ▲ and ▼.

### Quick start wizard

The quick-start wizard guides you in the quick configuration application through all important settings that have to be made or that you should check for your application (see A in **Figure 13**). The parameters that are called during the process are listed in **Table 10** on **Page 32** in column Basic (Standard Drive).



The process is run from parameter to parameter. Returning is not possible here.

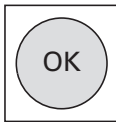

In the quick-configuration, the OK button activates the individual parameter values and then moves on to the next parameter. Every parameter always shows the value that is set in alternating sequence. By actuating the OK button again, you activate the value (value flashes).

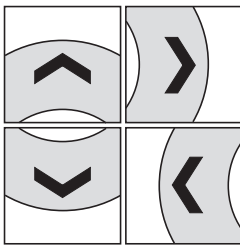

In the quick-configuration, the arrow keys have a limited functionality (changing parameter values).

The quick configuration is completed when the frequency display M1.1 is activated automatically. Selecting the PAR main menu again enables you to call up the parameters of the quick configuration.

Besides the parameters of the Quick Configuration, system parameters S1.1 to S4.2 are also shown after the initial setting. With P1.1 = 0 you can select access to all parameters; the keys of the operator panel are fully functional (free parameterization, see B in **Figure 13**).

This exits the quick-configuration and the guided setup with the quick-start assistant.

**Example: Motor parameters (P7)**

For optimal operation, you should enter the ratings plate information for the motor here. This information makes up the base values for the motor controller (electrical reproduction).

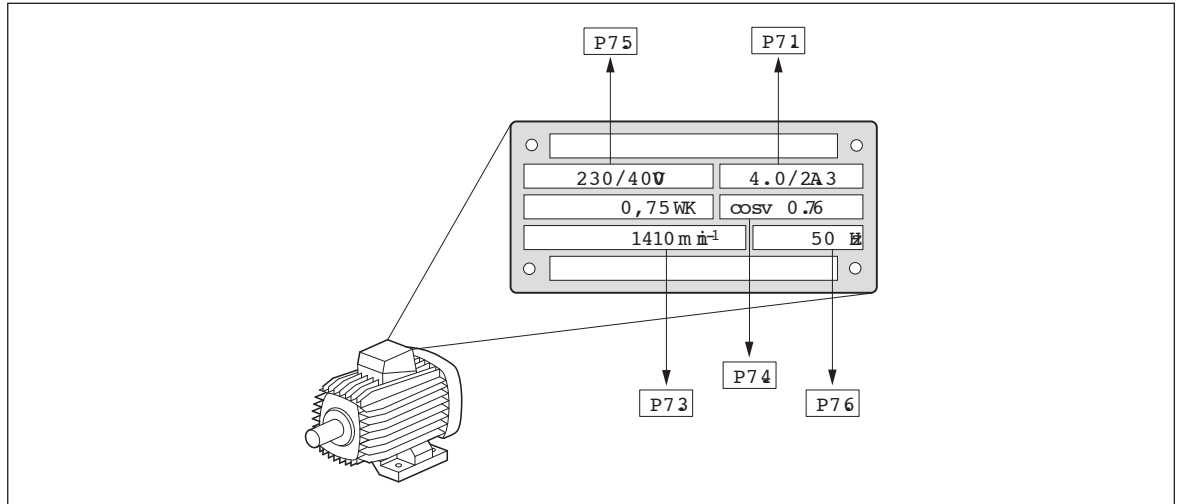

**Figure 14: Motor Parameters From Ratings Plate**



The motor data is set to the rated operation data for the adjustable frequency drive and depends on the performance variables in factory settings (see 1)).

When selecting the rating data, take the dependency of the type of switching on the strength of the feeding mains voltage into account:

- 230V (P7.5) → delta circuit A → P7.1 = 4A
- 400V (P7.5) → star connection → P7.1 = 2.3A

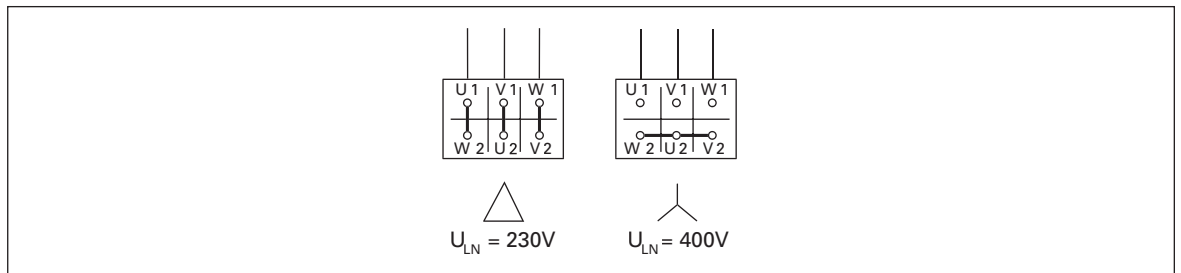

**Figure 15: Circuits (Delta, Star)**

Example: Single-phase connection of the MMX12AA4D8... adjustable frequency drive to a 230V mains voltage. The stator winding of the motor is connected in a delta circuit (motor rated current 4A as per rating plate **Figure 14**). See <sup>1)</sup> in the factory settings.

Required changes for the electrical reproduction for the motor:

P7.1 = 4.0, P7.3 = 1410, P7.4 = 0.67

P7.5 = 230V und P7.6 = 50 Hz are the default settings (P1.3 = 0) of the MMX12.

### List of parameters



Detailed information on the individual parameters is provided in the manual MN04020001E

### Quick configuration (basis)



When first switching on or after activating the default settings (S4.2 = 1), you are guided step by step through the provided parameters by the quick-start assistant. The defined values are confirmed with the OK button or they can be changed to suit your application and the motor data.

The quick-start assistant can be switched off in the first parameter (P1.1) by entering a zero (access to all parameters).

In parameter P1.2, you can switch to the specified application setting with the quick-start assistant (see **Table 10** on **Page 32**).

The quick-start assistant ends this first cycle by automatically switching to frequency display (M1.1 = 0.00 Hz).

By selecting the parameter level (PAR) again, besides the selected parameters for the quick-configuration, the system parameters (S) are also shown in other cycles.

**Table 9: Quick Configuration**

| PNU  | ID   | Access Right RUN | Designation                            | Value Range   | Factory Setting | User Setting |
|------|------|------------------|--|---|-----------------|--------------|
| P1.1 | 115  | ✓                | Parameter range                        | 0 = All parameters<br>1 = Only quick configuration parameters   | 1               |              |
| P1.2 | 540  | —                | Application                            | 0 = Basic<br>1 = Pump drive<br>2 = Fan drive<br>3 = High starting load  | 0               |              |
| P1.3 | 1472 | —                | Factory setting (WE), Country-specific | (enabled and visible only in the Quick Start wizard)<br>0 = EU (50 Hz defaults)<br>1 = USA (60 Hz defaults)   | 0               |              |
| P6.1 | 125  | ✓                | Remote control place                   | 1 = Control signal terminals (I/O)<br>2 = Control unit (KEYPAD)<br>3 = Field bus (BUS)  | 3               |              |
| P6.2 | 117  | ✓                | Remote reference                       | 0 = Fixed frequency (FF0)<br>1 = Keypad (REF)<br>2 = Field bus (BUS)<br>3 = AI1 (analog set point 1)<br>4 = AI2 (analog set point 2)<br>5 = Motor potentiometer | 3               |              |
| P6.3 | 101  | —                | Minimum frequency                      | 0.00 – P6.4 Hz  | 0.00            |              |
| P6.4 | 102  | —                | Maximum frequency                      | 6.3 – 320.00 Hz   | 60.00           |              |
| P6.5 | 103  | —                | Acceleration time (acc1)               | 0.1 – 3000s   | 3.0             |              |





February 2010

**Table 9: Quick Configuration (continued)**

| PNU   | ID  | Access Right RUN | Designation                          | Value Range   | Factory Setting | User Setting |
|-------|-----|------------------|--------------------------------------|---|-----------------|--------------|
| P6.6  | 104 | —                | Deceleration time (dec1)             | 0.1 – 3000s   | 3.0             |              |
| P6.7  | 505 | —                | Start function                       | 0 = Acceleration time (ramp)<br>1 = Flying restart circuit    | 0               |              |
| P6.8  | 506 | —                | Stop function                        | 0 = Free coasting<br>1 = Deceleration time (ramp)             | 0               |              |
| P7.1  | 113 | —                | Motor, rated current                 | $0.2 \times I_e \dots 2 \times I_e$<br>(→ Motor rating plate) | $I_e$           |              |
| P7.3  | 112 | —                | Motor, rated speed                   | 300 – 20,000 rpm<br>(→ Motor rating plate)                    | 1720            |              |
| P7.4  | 120 | —                | Motor, power factor (cos $\varphi$ ) | 0.30 – 1.00<br>(→ Motor rating plate)                         | 0.85            |              |
| P7.5  | 110 | —                | Motor, rated operating voltage       | 180 – 500V<br>(→ Motor rating plate)                          | 230/480         |              |
| P7.6  | 111 | —                | Motor, rated frequency               | 30 – 320 Hz<br>(→ Motor rating plate)                         | 50.00           |              |
| P11.7 | 109 | —                | Torque increase                      | 0 = Deactivated<br>1 = Enabled                                | 0               |              |
| M1.1  | 1   | —                | Output frequency                     | Hz  | 0.00            |              |

**Table 10** shows the preset application parameters of parameter P1.2.

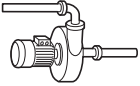
**Table 10: Predefined Application Parameters From Parameter P1.2**

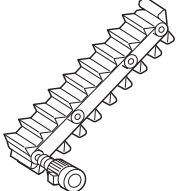
| Parameters | Designation                                       | <br>Basic<br>(Standard Drive) | <br>Pump Drive | <br>Fan Drive | <br>Feed Unit<br>(High Load) |
|------------|---|--|---|--|---|
| P1.1       | Parameter range                                   | 1 = Only quick configuration parameters  | 1 = Only quick configuration parameters   | 1 = Only quick configuration parameters  | 1 = Only quick configuration parameters   |
| P1.2       | Application                                       | 0 = Basic  | 1 = Pump drive  | 2 = Fan drive  | 3 = Hoisting device (high load)   |
| P6.1       | Control level                                     | 1 = Control signal terminals (I/O) (I/O)   | 1 = Control signal terminals (I/O) (I/O)  | 1 = Control signal terminals (I/O) (I/O)   | 1 = Control signal terminals (I/O) (I/O)  |
| P6.2       | Set point input (0 – 10 V) for terminal 2         | 3 = AI1 (analog set point 1)   | 3 = AI1 (analog set point 1)  | 3 = AI1 (analog set point 1)   | 3 = AI1 (analog set point 1)  |
| P6.3       | Minimum frequency                                 | 0.00 Hz  | 20.00 Hz  | 20.00 Hz   | 0.00 Hz   |
| P6.4       | Maximum frequency                                 | 60 Hz  | 60 Hz   | 60 Hz  | 60 Hz   |
| P6.5       | Acceleration time (acc1)                          | 3.0s   | 5.0s  | 20.0s  | 1.0s  |
| P6.6       | Deceleration time (dec1)                          | 3.0s   | 5.0s  | 20.0s  | 1.0s  |
| P6.8       | Stop function                                     | 0 = Free coasting  | 1 = Deceleration time (ramp)  | 0 = Free coasting  | 0 = Free coasting   |
| P7.1       | Motor, Rated current <sup>②</sup>                 | $I_e$  | $I_e$   | $I_e$  | $I_e$   |
| P7.3       | Motor, rated speed (rpm) <sup>②</sup>             | 1440/1720 rpm  | 1440/1720 rpm   | 1440/1720 rpm  | 1440/1720 rpm   |
| P7.4       | Motor, power factor (cos $\varphi$ ) <sup>②</sup> | 0.85   | 0.85  | 0.85   | 0.85  |
| P7.5       | Motor, rated operating voltage                    | 230/480V <sup>①</sup>  | 230/480V <sup>①</sup>   | 230/480V <sup>①</sup>  | 230/480V <sup>①</sup>   |
| P7.6       | Motor, rated frequency                            | 60 Hz  | 60 Hz   | 60 Hz  | 60 Hz   |
| P11.7      | Torque increase                                   | 0 = Deactivated  | 0 = Deactivated   | 0 = Deactivated  | 1 = Enabled   |
| M1.1       | Output frequency                                  | 0.00 Hz  | 0.00 Hz   | 0.00 Hz  | 0.00 Hz   |

<sup>①</sup> 230V = MMX11..., MMX12..., MMX32...480V = MMX34...

<sup>②</sup> Depends on performance variables.

**All Parameters**



When first switching on or after activating the default settings (S4.2 = 1) parameter P1.1 must be set to 0 for access to all parameters.

**Table 11: All Parameters**

| PNU | ID | Access Right RUN | Designation | Value Range | Factory Setting | User Setting |
|-----|----|------------------|-------------|-------------|-----------------|--------------|
|-----|----|------------------|-------------|-------------|-----------------|--------------|

**Parameter Selection**

|      |      |   |   |   |   |  |
|------|------|---|---|---|---|--|
| P1.1 | 115  | ✓ | Parameter range                           | 0 = All parameters<br>1 = Only quick configuration parameters   | 1 |  |
| P1.2 | 540  | — | Application                               | 0 = Basic<br>1 = Pump drive<br>2 = Fan drive<br>3 = High starting torque  | 0 |  |
| P1.3 | 1472 | — | Factory setting (WE),<br>Country-specific | (enabled and visible only in the quick start wizard)<br>0 = EU (50 Hz-based defaults)<br>1 = USA (60 Hz-based defaults) | 0 |  |

**Analog Input**

|      |     |   |                           |   |     |  |
|------|-----|---|---------------------------|---|-----|--|
| P2.1 | 379 | ✓ | AI1, Signal range         | (DIP switch S2)<br>0 = 0V/0 mA<br>1 = 2V/4 mA | 0   |  |
| P2.2 | 380 | ✓ | AI1, minimum value        | -100.00 – 100.00%                             | 0   |  |
| P2.3 | 381 | ✓ | AI1, maximum value        | -100.00 – 100.00%                             | 100 |  |
| P2.4 | 378 | ✓ | AI1, filter time constant | 0.0 – 10.0s                                   | 0.1 |  |
| P2.5 | 390 | ✓ | AI2, Signal range         | (DIP switch S3)<br>Like P2.1                  | 3   |  |
| P2.6 | 391 | ✓ | AI2, minimum value        | -100.00 – 100.00%                             | 0   |  |
| P2.7 | 392 | ✓ | AI2, maximum value        | -100.00 – 100.00%                             | 100 |  |
| P2.8 | 389 | ✓ | AI2, filter time constant | 0.0 – 10.0s                                   | 0.1 |  |

**Digital Input**

|      |     |   |                  |  |   |  |
|------|-----|---|------------------|--|---|--|
| P3.1 | 300 | ✓ | Start/stop logic | 0 = DI1 (FWD), DI2 (REV)<br>1 = DI1 (START), DI2 (REVERSE)<br>2 = DI1 (Start pulse), DI2 (Stop pulse)<br>3 = DI1 (FWD), DI2 (REV) and REAF | 3 |  |
| P3.2 | 403 | ✓ | Start signal     | 0 = Deactivated<br>1 = DI1<br>2 = DI2<br>3 = DI3<br>4 = DI4<br>5 = DI5<br>6 = DI6  | 1 |  |

**Table 11: All Parameters (continued)**

| PNU                              | ID   | Access Right RUN | Designation                             | Value Range | Factory Setting | User Setting |
|----------------------------------|------|------------------|---|-------------|-----------------|--------------|
| <b>Digital Input (continued)</b> |      |                  |   |             |                 |              |
| P3.3                             | 404  | ✓                | Start signal [2]                        | like P3.2   | 2               |              |
| P3.4                             | 412  | ✓                | Reversing                               | like P3.2   | 0               |              |
| P3.5                             | 405  | ✓                | External fault (N/O)                    | like P3.2   | 0               |              |
| P3.6                             | 406  | ✓                | External fault (N/C)                    | like P3.2   | 0               |              |
| P3.7                             | 414  | ✓                | Acknowledge fault (Reset)               | like P3.2   | 0               |              |
| P3.8                             | 407  | ✓                | Start enable                            | like P3.2   | 5               |              |
| P3.9                             | 419  | ✓                | Fixed speed B0                          | like P3.2   | 0               |              |
| P3.10                            | 420  | ✓                | Fixed speed B1                          | like P3.2   | 3               |              |
| P3.11                            | 421  | ✓                | Fixed speed B2                          | like P3.2   | 4               |              |
| P3.12                            | 1020 | ✓                | PI controller, deactivated              | like P3.2   | 0               |              |
| P3.13                            | 1400 | ✓                | Thermistor input                        | like P3.2   | 6               |              |
| P3.14                            | 1401 | ✓                | External brake                          | like P3.2   | 0               |              |
| P3.15                            | 1402 | ✓                | Acceleration / deceleration time [2]    | like P3.2   | 0               |              |
| P3.16                            | 1403 | ✓                | Inhibit acceleration/ deceleration      | like P3.2   | 0               |              |
| P3.17                            | 1404 | ✓                | Parameters locked                       | like P3.2   | 0               |              |
| P3.18                            | 1405 | ✓                | Motor potentiometer, increase set point | like P3.2   | 0               |              |
| P3.19                            | 1406 | ✓                | Motor potentiometer, reduce set point   | like P3.2   | 0               |              |
| P3.20                            | 1407 | ✓                | Motor potentiometer, zero set point     | like P3.2   | 0               |              |
| P3.21                            | 1408 | ✓                | Program scan, start                     | like P3.2   | 0               |              |
| P3.22                            | 1409 | ✓                | Program scan, pause                     | like P3.2   | 0               |              |
| P3.23                            | 1410 | ✓                | Counter, trigger signal                 | like P3.2   | 0               |              |
| P3.24                            | 1411 | ✓                | Counter, reset                          | like P3.2   | 0               |              |
| P3.25                            | 1412 | ✓                | First/second source for control place   | like P3.2   | 0               |              |

**Table 11: All Parameters (continued)**

| PNU                              | ID   | Access Right RUN | Designation                                 | Value Range  | Factory Setting | User Setting |
|----------------------------------|------|------------------|---|--|-----------------|--------------|
| <b>Digital Input (continued)</b> |      |                  |   |  |                 |              |
| P3.26                            | 1413 | ✓                | First/second source for I/O reference value | like P3.2  | 0               |              |
| P3.27                            | 1414 | ✓                | Second parameter set                        | like P3.2  | 0               |              |
| P3.28                            | 1415 | ✓                | Field bus pass through                      | like P3.2  | 0               |              |
| P3.29                            | 1416 | ✓                | Output trigger counter value 1              | 0 – 65535  | 0               |              |
| P3.30                            | 1417 | ✓                | Output trigger counter value 2              | 0 – 65535  | 0               |              |
| P3.31                            | 1418 | ✓                | DI1 Logic                                   | 0 = N/O<br>1 = N/C   | 0               |              |
| P3.32                            | 1419 | ✓                | DI2 Logic                                   | Like P3.31   | 0               |              |
| P3.33                            | 1420 | ✓                | DI3 Logic                                   | Like P3.31   | 0               |              |
| P3.34                            | 1421 | ✓                | DI4 Logic                                   | Like P3.31   | 0               |              |
| P3.35                            | 1422 | ✓                | DI5 Logic                                   | Like P3.31   | 0               |              |
| P3.36                            | 1423 | ✓                | DI6 Logic                                   | Like P3.31   | 0               |              |
| P3.37                            | 1480 | ✓                | Hand mode                                   | 0-6  | 0               |              |
| <b>Analog Output</b>             |      |                  |   |  |                 |              |
| P4.1                             | 307  | ✓                | AO signal                                   | 0 = Deactivated<br>1 = Output frequency ( $0 - f_{max}$ )<br>2 = Output current ( $0 - I_{N Motor}$ )<br>3 = Torque ( $0 - M_N$ )<br>4 = PID controller, output  | 1               |              |
| P4.2                             | 310  | ✓                | AO, minimum value                           | 0 = 0 mA<br>1 = 4 mA   | 0               |              |
| P4.3                             | 1456 | ✓                | AO, gain                                    | 0.00 – 200.00%   | 100.00          |              |
| P4.4                             | 1477 | ✓                | AO, filter time                             | 0.00 – 10.00s  | 0.1             |              |
| <b>Digital Output</b>            |      |                  |   |  |                 |              |
| P5.1                             | 313  | ✓                | RO1 signal                                  | 0 = Deactivated<br>1 = Ready to start (READY)<br>2 = Operation (RUN)<br>3 = Fault signal (FAULT)<br>4 = Error message (inverted)<br>5 = Warning (ALARM)<br>6 = Reversing (FWD ↔ REV)<br>7 = Reference frequency reached<br>8 = Motor controller active<br>9 = Zero frequency<br>10 = Frequency monitoring 1<br>11 = Frequency monitoring 2<br>12 = PID monitoring<br>13 = Overtemperature-monitoring<br>14 = Overcurrent control active<br>15 = Overvoltage control active | 2               |              |

**Table 11: All Parameters (continued)**

| PNU                               | ID   | Access Right RUN | Designation                            | Value Range  | Factory Setting | User Setting |
|-----------------------------------|------|------------------|--|--|-----------------|--------------|
| <b>Digital Output (continued)</b> |      |                  |  |  |                 |              |
| P5.1<br>(con't.)                  | 313  | ✓                | RO1 signal                             | 16 = Flow control active<br>17 = Flow control, single step<br>18 = Flow control, program cycle completed<br>19 = Flow control, pause<br>20 = Counter reference value 1 active<br>21 = Counter reference value 2 active<br>22 = RUN signal active<br>23 = 4 mA warning<br>24 = Result of logic function<br>25 = PID controller, process value monitoring<br>26 = External brake actuated<br>27 = Current monitoring<br>28 = Field bus signal switched through | 2               |              |
| P5.2                              | 314  | ✓                | RO2 signal                             | Like P5.1  | 3               |              |
| P5.3                              | 312  | ✓                | DO1 signal                             | Like P5.1  | 1               |              |
| P5.4                              | 315  | ✓                | Frequency monitor                      | 0 = Deactivated<br>1 = Minimum<br>2 = Maximum  | 0               |              |
| P5.5                              | 316  | ✓                | Frequency monitor, reference value     | 0.00 – 320.00 Hz   | 0.00            |              |
| P5.6                              | 346  | ✓                | Frequency monitor [2]                  | 0 = Deactivated<br>1 = Minimum value<br>2 = Maximum value  | 0               |              |
| P5.7                              | 347  | ✓                | Frequency monitor [2], reference value | 0.00 – 320.00 Hz   | 0.00            |              |
| P5.8                              | 1457 | ✓                | Current monitor, reference value       | 0.00 – I <sub>e</sub> A  | 0.00            |              |
| P5.9                              | 1458 | ✓                | DO logic                               | 0 = N/O<br>1 = N/C   | 0               |              |
| P5.10                             | 1331 | ✓                | RO1 logic                              | Like P5.9  | 0               |              |
| P5.11                             | 1332 | ✓                | RO2 logic                              | Like P5.9  | 0               |              |
| P5.12                             | 1459 | ✓                | DO on delay                            | 0.00 – 320.00s   | 0.00            |              |
| P5.13                             | 1460 | ✓                | DO off delay                           | 0.00 – 320.00s   | 0.00            |              |
| P5.14                             | 1461 | ✓                | RO1 switch-on delay                    | 0.00 – 320.00s   | 0.00            |              |
| P5.15                             | 1424 | ✓                | RO1 off delay                          | 0.00 – 320.00s   | 0.00            |              |
| P5.16                             | 1425 | ✓                | RO2 switch-on delay                    | 0.00 – 320.00s   | 0.00            |              |
| P5.17                             | 1426 | ✓                | RO2 off delay                          | 0.00 – 320.00s   | 0.00            |              |

**Table 11: All Parameters (continued)**

| PNU                   | ID   | Access Right RUN | Designation  | Value Range   | Factory Setting | User Setting |
|-----------------------|------|------------------|--|---|-----------------|--------------|
| <b>Drives Control</b> |      |                  |  |   |                 |              |
| P6.1                  | 125  | ✓                | Remote control place                               | 1 = Control signal terminals (I/O)<br>2 = Control unit (KEYPAD)<br>3 = Field bus (BUS)  | 1               |              |
| P6.2                  | 117  | ✓                | Remote reference                                   | 0 = Fixed frequency (FF0)<br>1 = Keypad (REF)<br>2 = Field bus (BUS)<br>3 = AI1 (analog set point 1)<br>4 = AI2 (analog set point 2)<br>5 = Motor potentiometer         | 1               |              |
| P6.3                  | 101  | —                | Min. frequency                                     | 0.00 – P6.4 Hz  | 0.00            |              |
| P6.4                  | 102  | —                | Max. frequency                                     | 6.3 – 320.00 Hz   | 60              |              |
| P6.5                  | 103  | —                | Acceleration time (acc1)                           | 0.1 – 3000s   | 3.0             |              |
| P6.6                  | 104  | —                | Deceleration time (dec1)                           | 0.1 – 3000s   | 3.0             |              |
| P6.7                  | 505  | —                | Start function                                     | 0 = Acceleration time (ramp)<br>1 = Flying restart  | 0               |              |
| P6.8                  | 506  | —                | Stop function                                      | 0 = Free coasting<br>1 = Deceleration time (ramp)   | 0               |              |
| P6.9                  | 500  | —                | S ramp, temporal S form                            | 0.00 = Linear<br>0.1 – 10.0s (S-shaped)   | 0.0             |              |
| P6.10                 | 717  | —                | Automatic restart (REAF), wait time, (→ P6.13 = 1) | 0.10 – 10.00s   | 0.50            |              |
| P6.11                 | 718  | —                | Automatic restart (REAF), test time, (→ P6.13 = 1) | 0.00 – 60.00s   | 30.00           |              |
| P6.12                 | 719  | —                | Automatic restart (REAF), start function           | 0 = Acceleration time (ramp)<br>1 = Flying restart circuit<br>2 = according to P6.7   | 0               |              |
| P6.13                 | 731  | —                | Automatic restart                                  | 0 = Inhibited<br>1 = Enabled  | 0               |              |
| P6.14                 | 1600 | —                | Stop on direction reversal                         | 0 = No<br>1 = Yes   | 1               |              |
| P6.15                 | 184  | —                | Keypad reference, operating unit                   | 0.00 – P6.4 Hz  | 0               |              |
| P6.16                 | 1474 | —                | Stop button active                                 | 0 = No<br>1 = Yes   | 1               |              |
| P6.17                 | 1427 | —                | Remote control place [2]                           | 1 = Control signal terminals (I/O)<br>2 = Control unit (KEYPAD)<br>3 = Field bus (BUS)  | 3               |              |
| P6.18                 | 1428 | —                | Remote reference [2]                               | 0 = Fixed frequency (FF0)<br>1 = Operating unit (REF)<br>2 = Field bus (BUS)<br>3 = AI1 (analog set point 1)<br>4 = AI2 (analog set point 2)<br>5 = Motor potentiometer | 2               |              |

**Table 11: All Parameters (continued)**

| PNU                               | ID   | Access Right RUN | Designation                        | Value Range   | Factory Setting  | User Setting |
|-----------------------------------|------|------------------|------------------------------------|---|------------------|--------------|
| <b>Drives Control (continued)</b> |      |                  |                                    |   |                  |              |
| P6.19                             | 502  | —                | Acceleration time (acc2)           | 0.1 – 3000s   | 10.0             |              |
| P6.20                             | 503  | —                | Deceleration time (dec2)           | 0.1 – 3000s   | 10.0             |              |
| P6.21                             | 526  | —                | Transition frequency (acc1 – acc2) | 0.00 – P6.4 Hz  | 0.00             |              |
| P6.22                             | 1334 | —                | Transition frequency (dec1 – dec2) | 0.00 – P6.4 Hz  | 0.00             |              |
| P6.23                             | 1429 | —                | REV inhibited                      | 0 = No<br>1 = Yes   | 0                |              |
| P6.24                             | 509  | —                | Skip frequency 1, lower value      | 0.00 – P6.4 Hz  | 0.00             |              |
| P6.25                             | 510  | —                | Skip frequency 1, upper value      | 0.00 – P6.4 Hz  | 0.00             |              |
| P6.26                             | 511  | —                | Skip frequency 2, lower value      | 0.00 – P6.4 Hz  | 0.00             |              |
| P6.27                             | 731  | —                | Skip frequency 2, upper value      | 0.00 – P6.4 Hz  | 0.00             |              |
| P6.28                             | 513  | —                | Skip frequency 3, lower value      | 0.00 – P6.4 Hz  | 0.00             |              |
| P6.29                             | 514  | —                | Skip frequency 3, upper value      | 0.00 – P6.4 Hz  | 0.00             |              |
| P6.30                             | 759  | —                | Automatic restart, number          | 1 – 10  | 3                |              |
| P6.31                             | 1481 | —                | Hand mode control place            | 1 – 3   | 1                |              |
| P6.32                             | 1482 | —                | Hand mode reference                | 0 – 5   | 3                |              |
| P6.33                             | 1483 | —                | Hand mode keypad lock              | 0 – 1   | 1                |              |
| <b>Motor</b>                      |      |                  |                                    |   |                  |              |
| P7.1                              | 113  | —                | Motor, rated current               | $0.2 \times I_e \dots 2 \times I_e$<br>(→ Motor rating plate) | $I_e$            |              |
| P7.2                              | 107  | —                | Current limit                      | $0.2 \times I_e \dots 2 \times I_e$                           | $1.5 \times I_e$ |              |
| P7.3                              | 112  | —                | Motor, rated speed                 | 300 – 20,000 rpm<br>(→ Motor rating plate)                    | 1720             |              |
| P7.4                              | 120  | —                | Motor, power factor (cos φ)        | 0.30 – 1.00<br>(→ Motor rating plate)                         | 0.85             |              |
| P7.5                              | 110  | —                | Motor, rated operating voltage     | 180 – 500V<br>(→ Motor rating plate)                          | 230<br>480       |              |
| P7.6                              | 111  | —                | Motor, rated frequency             | 30 – 320 Hz<br>(→ Motor rating plate)                         | 60 Hz            |              |



**Table 11: All Parameters (continued)**

| PNU                         | ID   | Access Right RUN | Designation                              | Value Range   | Factory Setting | User Setting |
|-----------------------------|------|------------------|--|---|-----------------|--------------|
| <b>Protective Functions</b> |      |                  |  |   |                 |              |
| P8.1                        | 700  | —                | 4 mA reference value error               | 0 = Deactivated<br>1 = Warning<br>2 = Error, stop according to P6.8     | 1               |              |
| P8.3                        | 703  | —                | Earth-fault monitoring                   | Like P8.1   | 2               |              |
| P8.4                        | 709  | —                | Stall protection                         | Like P8.1   | 0               |              |
| P8.5                        | 713  | —                | Underload protection                     | Like P8.1   | 0               |              |
| P8.6                        | 704  | —                | Motor, temperature protection            | Like P8.1   | 0               |              |
| P8.7                        | 705  | —                | Motor, ambient temperature               | -20 – +100°C  | 40              |              |
| P8.8                        | 706  | —                | Motor, cooling factor at zero frequency  | 0.0 – 150%  | 40              |              |
| P8.9                        | 707  | —                | Motor, thermal time constant             | 1 – 200 min   | 45              |              |
| P8.10                       | 1430 | —                | 4 mA reference value error               | 0.0 – 10.0s   | 0.5             |              |
| P8.11                       | 1473 | —                | Thermistor fault, response               | Like P8.1   | 2               |              |
| P8.12                       | 714  | —                | Underload, load curve at rated frequency | 10.0 – 150%   | 50.0            |              |
| P8.13                       | 715  | —                | Underload, load curve at frequency = 0   | 10.0 – 150%   | 10.0            |              |
| <b>PID Controller</b>       |      |                  |  |   |                 |              |
| P9.1                        | 163  | —                | PID controller                           | 0 = Deactivated<br>1 = to drive control<br>2 = for external application | 0               |              |
| P9.2                        | 118  | —                | PID controllers, P gain                  | 0.0 – 1000.0%   | 100.0           |              |
| P9.3                        | 119  | —                | PID controller, I time                   | 0.00 – 320.00s  | 10.00           |              |
| P9.4                        | 167  | —                | PID controller, Keypad reference         | 0.0 – 100.0%  | 0.0             |              |
| P9.5                        | 332  | —                | PI controller, set point source          | 0 = Keypad (P9.4)<br>1 = Field bus (option)<br>2 = AI1<br>3 = AI2       | 0               |              |

**Table 11: All Parameters (continued)**

| PNU                               | ID   | Access Right RUN | Designation                                    | Value Range                                  | Factory Setting | User Setting |
|-----------------------------------|------|------------------|--|--|-----------------|--------------|
| <b>PID Controller (continued)</b> |      |                  |  |  |                 |              |
| P9.6                              | 334  | —                | PID controller, actual value                   | 0 = Field bus (option)<br>1 = AI1<br>2 = AI2 | 2               |              |
| P9.7                              | 336  | —                | PID controller, actual value limiting, minimum | 0.0 – 100.0%                                 | 0.0             |              |
| P9.8                              | 337  | —                | PID controller, actual value limiting, maximum | 0.0 – 100.0%                                 | 100.0           |              |
| P9.9                              | 340  | —                | PID controller, controller deviation           | 0 = not inverted<br>1 = inverted             | 0               |              |
| P9.10                             | 132  | —                | PID controller, D rate time                    | 0.00 – 10.0s                                 | 0.00            |              |
| P9.11                             | 1431 | —                | PID controller, output filter, delay time      | 0.00 – 10.0s                                 | 0.0             |              |
| P9.12                             | 1016 | —                | Sleep mode, frequency                          | 0.00 – P6.4 Hz                               | 0.00            |              |
| P9.13                             | 1018 | —                | Sleep mode, wake-up frequency                  | 0.0 – 100.0%                                 | 25.0            |              |
| P9.14                             | 1017 | —                | Sleep mode, delay time                         | 0 – 3600s                                    | 30              |              |
| P9.15                             | 1433 | —                | Hysteresis, upper threshold                    | 0.0 – 100.0%                                 | 0.0             |              |
| P9.16                             | 1434 | —                | Hysteresis, lower threshold                    | 0.0 – 100.0%                                 | 0.0             |              |
| P9.17                             | 1435 | —                | PID controller, max. system derivation         | 0.0 – 100.0%                                 | 3.0             |              |
| P9.18                             | 1475 | —                | PID controller, reference value scaling        | 0.1 – 32.7                                   | 1.0             |              |
| P9.19                             | 1476 | —                | PID controller, process value scaling          | 0.1 – 32.7                                   | 1.0             |              |
| <b>Fixed Frequencies</b>          |      |                  |  |  |                 |              |
| P10.1                             | 124  | ✓                | Fixed frequency FF0                            | 0.00 – P6.4 Hz                               | 5.00            |              |
| P10.2                             | 105  | ✓                | Fixed frequency FF1                            | 0.00 – P6.4 Hz                               | 10.00           |              |
| P10.3                             | 106  | ✓                | Fixed frequency FF2                            | 0.00 – P6.4 Hz                               | 15.00           |              |

**Table 11: All Parameters (continued)**

| PNU                                  | ID   | Access Right RUN | Designation                                     | Value Range  | Factory Setting | User Setting |
|--------------------------------------|------|------------------|---|--|-----------------|--------------|
| <b>Fixed Frequencies (continued)</b> |      |                  |   |  |                 |              |
| P10.4                                | 126  | ✓                | Fixed frequency FF3                             | 0.00 – P6.4 Hz   | 20.00           |              |
| P10.5                                | 127  | ✓                | Fixed frequency FF4                             | 0.00 – P6.4 Hz   | 25.00           |              |
| P10.6                                | 128  | ✓                | Fixed frequency FF5                             | 0.00 – P6.4 Hz   | 30.00           |              |
| P10.7                                | 129  | ✓                | Fixed frequency FF6                             | 0.00 – P6.4 Hz   | 40.00           |              |
| P10.8                                | 130  | ✓                | Fixed frequency FF7                             | 0.00 – P6.4 Hz   | 50.00           |              |
| P10.9                                | 1436 | ✓                | Flow control                                    | 0 = Deactivated<br>1 = Program cycle, once<br>2 = Program cycle, continuous<br>3 = Program cycle, step by step<br>4 = Program cycle, continuous and step by step | 0               |              |
| P10.10                               | 1437 | ✓                | Flow control, FWD/REV bit                       | 0 – 255  | 0               |              |
| P10.11                               | 1438 | ✓                | Set time for FF0                                | 0 – 10000s   | 0               |              |
| P10.12                               | 1439 | ✓                | Set time for FF1                                | 0 – 10000s   | 0               |              |
| P10.13                               | 1440 | ✓                | Set time for FF2                                | 0 – 10000s   | 0               |              |
| P10.14                               | 1441 | ✓                | Set time for FF3                                | 0 – 10000s   | 0               |              |
| P10.15                               | 1442 | ✓                | Set time for FF4                                | 0 – 10000s   | 0               |              |
| P10.16                               | 1443 | ✓                | Set time for FF5                                | 0 – 10000s   | 0               |              |
| P10.17                               | 1444 | ✓                | Set time for FF6                                | 0 – 10000s   | 0               |              |
| P10.18                               | 1445 | ✓                | Set time for FF7                                | 0 – 10000s   | 0               |              |
| <b>V/Hz Characteristic Curve</b>     |      |                  |   |  |                 |              |
| P11.1                                | 108  | —                | V/Hz characteristic curve                       | 0 = Linear<br>1 = Squared<br>2 = Configurable  | 0               |              |
| P11.2                                | 602  | —                | Cut-off frequency                               | 30.00 – 320.00 Hz  | 60              |              |
| P11.3                                | 603  | —                | Output voltage                                  | 10.00 – 200.00% of nominal motor voltage (P6.5)  | 100.00          |              |
| P11.4                                | 604  | —                | V/Hz characteristic curve, mean frequency value | 0.00 – P11.2 Hz  | 60              |              |
| P11.5                                | 605  | —                | V/Hz characteristic curve, mean voltage value   | 0.00 – P11.3%  | 100.00          |              |
| P11.6                                | 606  | —                | Output voltage at zero frequency                | 0.00 – 40.00 %   | 0.00            |              |
| P11.7                                | 109  | —                | Torque increase                                 | 0 = Deactivated<br>1 = Enabled   | 0               |              |

**Table 11: All Parameters (continued)**

| PNU  | ID   | Access Right RUN | Designation                                      | Value Range   | Factory Setting | User Setting |
|--|------|------------------|--|---|-----------------|--------------|
| <b>V/Hz Characteristic Curve (continued)</b> |      |                  |  |   |                 |              |
| P11.8  | 600  | —                | Motor control mode                               | 0 = Frequency control (V/Hz)<br>1 = Speed control (vector)  | 0               |              |
| P11.9  | 601  | —                | Pulse frequency                                  | 1.5 – 16.0 kHz  | 6.0             |              |
| P11.10                                       | 522  | —                | Sine-wave filter                                 | 0 = Deactivated<br>1 = Enabled  | 0               |              |
| <b>Braking</b>                               |      |                  |  |   |                 |              |
| P12.1  | 507  | —                | DC braking, current                              | $0.2 \times I_e - 2 \times I_e$   | $I_e$           |              |
| P12.2  | 516  | —                | DC braking, braking time in case of RUN          | 0.00 – 600.00s  | 0.00            |              |
| P12.3  | 515  | —                | DC braking, start frequency                      | 0.00 – 10.00 Hz   | 1.50            |              |
| P12.4  | 508  | —                | DC braking, braking time in case of STOP         | 0.00 – 600.00s  | 0.00            |              |
| P12.5  | 504  | —                | Brake chopper                                    | (only active and visible with braking transistor installed)<br>0 = Deactivated<br>1 = Active in RUN<br>2 = Active in RUN and STOP | 0               |              |
| P12.6  | 1447 | —                | Brake chopper, switching threshold               | (only active and visible with braking transistor installed)<br>0 – 870V   | 0               |              |
| P12.7  | 1448 | —                | External brake, delay time, opening              | 0.00 – 320.00s  | 0.20            |              |
| P12.8  | 1449 | —                | External brake, frequency threshold, opening     | 0.00 – 320.00 Hz  | 1.50            |              |
| P12.9  | 1450 | —                | External brake, frequency threshold, closing     | 0.00 – 320.00 Hz  | 1.50            |              |
| P12.10                                       | 1451 | —                | External brake, frequency threshold REV, closing | 0.00 – 320.00 Hz  | 1.50            |              |
| P12.11                                       | 1452 | —                | External brake, current limit                    | 0.00 – P7.2 A   | 0.00            |              |

**Table 11: All Parameters (continued)**

| PNU                         | ID   | Access Right RUN | Designation                          | Value Range   | Factory Setting  | User Setting |
|-----------------------------|------|------------------|--------------------------------------|---|------------------|--------------|
| <b>Logic Function</b>       |      |                  |                                      |   |                  |              |
| P13.1                       | 1453 | —                | Logic function – select input A      | 0 = Deactivated<br>1 = Ready to start (READY)<br>2 = Operation (RUN)<br>3 = Fault signal (FAULT)<br>4 = Error message (inverted)<br>5 = Warning (ALARM)<br>6 = Reversing (FWD ↔ REV)<br>7 = Reference frequency reached<br>8 = Motor controller active<br>9 = Zero frequency<br>10 = Frequency monitoring 1<br>11 = Frequency monitoring 2<br>12 = PID control<br>13 = Overtemperature-monitoring<br>14 = Overcurrent control active<br>15 = Overvoltage control active<br>16 = Flow control active<br>17 = Flow control, single step completed<br>18 = Flow control, program cycle completed<br>19 = Flow control, pause<br>20 = Counter set point 1 active<br>21 = Counter set point 2 active<br>22 = RUN signal active<br>23 = 4 mA warning<br>24 = Result of logic function<br>25 = PID controller, process value monitoring<br>26 = External brake actuated<br>27 = Current monitoring<br>28 = Field bus signal switched through | 0                |              |
| P13.2                       | 1454 | —                | Logic function – select input B      | see P13.1   | 0                |              |
| P13.3                       | 1455 | —                | Logic function – select link         | 0 = A AND B<br>1 = A OR B<br>2 = A XOR B  | 0                |              |
| <b>Second Parameter Set</b> |      |                  |                                      |   |                  |              |
| P14.1                       | 1347 | —                | Motor [2], rated operational current | $0.2 \times I_e \dots 2 \times I_e$<br>(→ Motor rating plate)   | $I_e$            |              |
| P14.2                       | 1352 | —                | Current limit [2]                    | $0.2 \times I_e \dots 2 \times I_e$   | $1.5 \times I_e$ |              |
| P14.3                       | 1350 | —                | Motor [2], rated speed               | 300 - 20000 rpm<br>(→ Motor rating plate)   | 1720             |              |
| P14.4                       | 1351 | —                | Motor[2], power factor (cos φ)       | 0.30 – 1.00<br>(→ Motor rating plate)   | 0.85             |              |
| P14.5                       | 1348 | —                | Motor[2], rated operating voltage    | 180 – 500 V<br>(→ Motor rating plate)   | 230<br>480       |              |

**Table 11: All Parameters (continued)**

| PNU                                     | ID   | Access Right RUN | Designation                          | Value Range                                     | Factory Setting | User Setting |
|---|------|------------------|--------------------------------------|---|-----------------|--------------|
| <b>Second Parameter Set (continued)</b> |      |                  |                                      |   |                 |              |
| P14.6                                   | 1349 | —                | Motor[2], rated frequency            | 30 – 320 Hz<br>(→ Motor rating plate)           | 60              |              |
| P14.7                                   | 1343 | —                | Minimum frequency [2]                | 0.00 – P6.4 Hz                                  | 0.00            |              |
| P14.8                                   | 1344 | —                | Maximum frequency [2]                | P6.3 – 320.00 Hz                                | 60              |              |
| P14.9                                   | 1345 | —                | Acceleration time [2]                | 0.1 – 3000s                                     | 3.0             |              |
| P14.10                                  | 1346 | —                | Deceleration time [2]                | 0.1 – 3000s                                     | 3.0             |              |
| P14.11                                  | 1355 | —                | V/Hz characteristic curve [2]        | 0 = Linear<br>1 = Quadratic<br>2 = Configurable | 0               |              |
| P14.12                                  | 1354 | —                | Torque boost [2]                     | 0 = Deactivated<br>1 = Enabled                  | 0               |              |
| P14.13                                  | 1353 | —                | Overload protection [2]              | Like P8.1                                       | 0               |              |
| P14.14                                  | 1469 | —                | Motor [2], ambient temperature       | -20 – +100 °C                                   | 40              |              |
| P14.15                                  | 1470 | —                | Cooling factor at zero frequency [2] | 0.0 – 150%                                      | 40.0            |              |
| P14.16                                  | 1471 | —                | Motor temperature time constant [2]  | 1 – 200 min                                     | 45              |              |

**System Parameters****Hardware and Software Information**

|      |     |   |                                 |   |   |  |
|------|-----|---|---------------------------------|---|---|--|
| S1.1 | 833 | — | Software-Package                | — | 0 |  |
| S1.2 | 834 | — | Software version, power section | — | 0 |  |
| S1.3 | 835 | — | Software version, control part  | — | 0 |  |
| S1.4 | 836 | — | Firmware, interface             | — | 0 |  |
| S1.5 | 837 | — | Application, ID                 | — | 0 |  |
| S1.6 | 838 | — | Application, revision           | — | 0 |  |
| S1.7 | 839 | — | System load                     | % | 0 |  |

**Table 11: All Parameters (continued)**

| PNU                   | ID  | Access Right RUN | Designation                   | Value Range   | Factory Setting | User Setting |
|-----------------------|-----|------------------|-------------------------------|---|-----------------|--------------|
| <b>Communications</b> |     |                  |                               |   |                 |              |
| S2.1                  | 808 | —                | Communication status          | Format xx.yyy<br>xx = number of error messages (0 – 64)<br>yyy = number of correct messages (0 – 999)     | 0               |              |
| S2.2                  | 809 | —                | Fault history                 | 0 = field bus deactivated<br>1 = Modbus   | 0               |              |
| S2.3                  | 810 | —                | Address (slave)               | 1 – 255   | 1               |              |
| S2.4                  | 811 | —                | Baud rates                    | 0 = 300<br>1 = 600<br>2 = 1200<br>3 = 2400<br>4 = 4800<br>5 = 9600<br>6 = 19200<br>7 = 38400<br>8 = 57600 | 5               |              |
| S2.5                  | 812 | —                | Number of stop bits           | 0 = 1 Stop bit<br>1 = 2 Stop bits   | 0               |              |
| S2.6                  | 813 | —                | Parity type                   | 0 = None (inaccessible)   | 0               |              |
| S2.7                  | 814 | —                | Communication status, Timeout | 0 = Not used<br>1 = 1s<br>2 = 2s<br>... 255s  | 0               |              |
| S2.8                  | 815 | —                | Reset communication status    | 0 = Not used<br>1 = Reset value of parameter S2.1   | 0               |              |
| <b>Unit Counter</b>   |     |                  |                               |   |                 |              |
| S3.1                  | 827 | —                | MWh counter                   | MWh   | 0.00            |              |
| S3.2                  | 828 | —                | Operation, days               | d   | 0               |              |
| S3.3                  | 829 | —                | Operation, hours              | H   | 0               |              |
| S3.4                  | 840 | —                | RUN, days                     | d   | 0               |              |
| S3.5                  | 841 | —                | RUN, hours                    | H   | 0               |              |
| S3.6                  | 842 | —                | RUN, meter                    |   | 0               |              |

**Table 11: All Parameters (continued)**

| PNU                   | ID   | Access Right RUN | Designation                 | Value Range  | Factory Setting | User Setting |
|-----------------------|------|------------------|-----------------------------|--|-----------------|--------------|
| <b>User Set</b>       |      |                  |                             |  |                 |              |
| S4.1                  | 830  | —                | Display contrast            | 0 – 15   | 7               |              |
| S4.2                  | 831  | —                | Factory setting (WE)        | 0 = Retain current values<br>1 = Clears all values and restores default settings | 0               |              |
| S4.3                  | 832  | —                | Password                    |  | 0               |              |
| <b>Display Values</b> |      |                  |                             |  |                 |              |
| M1.1                  | 1    | —                | Output frequency            | Hz   | 0.00            |              |
| M1.2                  | 25   | —                | Frequency reference value   | Hz   | 0.00            |              |
| M1.3                  | 2    | —                | Motor shaft speed           | rpm (calculated value, rpm)  | 0               |              |
| M1.4                  | 3    | —                | Motor current               | A  | 0.00            |              |
| M1.5                  | 4    | —                | Motor torque                | % (calculated value)   | 0.0             |              |
| M1.6                  | 5    | —                | Motor power                 | % (calculated value)   | 0.0             |              |
| M1.7                  | 6    | —                | Motor voltage               | V  | 0.0             |              |
| M1.8                  | 7    | —                | Intermediate DC bus voltage | V  | 0.0             |              |
| M1.9                  | 8    | —                | Unit temperature            | °C   | 0               |              |
| M1.11                 | 13   | —                | Analog input 1              | %  | 0.0             |              |
| M1.12                 | 14   | —                | Analog input 2              | %  | 0.0             |              |
| M1.13                 | 26   | —                | Analog output 1             | %  | 0.0             |              |
| M1.14                 | 15   | —                | Digital input 1 – 3         | DI1, DI2, DI3 status   | 0               |              |
| M1.15                 | 16   | —                | Digital input 4 – 6         | DI4, DI5, DI6 status   | 0               |              |
| M1.16                 | 17   | —                | Digital output              | RO1, RO2, DO status  | 1               |              |
| M1.17                 | 20   | —                | PID reference value         | %  | 0.0             |              |
| M1.18                 | 21   | —                | PID feedback                | %  | 0.0             |              |
| M1.19                 | 22   | —                | PID error value             | %  | 0.0             |              |
| M1.20                 | 23   | —                | PID output                  | %  | 0.0             |              |
| M1.21                 | 1479 | —                | Pulse counter value         | —  | 0.0             |              |



Parameters marked with "M" (Monitor) are values currently being measured, variables calculated from these measured values, or status values from control signals. They cannot be edited.





Eaton's Electrical Sector is a global leader in power distribution, power quality, control and automation, and monitoring products. When combined with Eaton's full-scale engineering services, these products provide customer-driven PowerChain Management® solutions to serve the power system needs of the data center, industrial, institutional, public sector, utility, commercial, residential, IT, mission critical, alternative energy and OEM markets worldwide.

PowerChain Management solutions help enterprises achieve sustainable and competitive advantages through proactive management of the power system as a strategic, integrated asset throughout its life cycle, resulting in enhanced safety, greater reliability and energy efficiency. For more information, visit [www.eaton.com/electrical](http://www.eaton.com/electrical).

