

High Performance Compact Inverter
FRENIC-Multi

User's Manual

Copyright © 2007 Fuji Electric FA Components & Systems Co., Ltd.

All rights reserved.

No part of this publication may be reproduced or copied without prior written permission from Fuji Electric FA Components & Systems Co., Ltd.

All products and company names mentioned in this manual are trademarks or registered trademarks of their respective holders.

The information contained herein is subject to change without prior notice for improvement.

Preface

This manual provides all the information on the FRENIC-Multi series of inverters including its operating procedure, operation modes, and selection of peripheral equipment. Carefully read this manual for proper use. Incorrect handling of the inverter may prevent the inverter and/or related equipment from operating correctly, shorten their lives, or cause problems.

The table below lists the other materials related to the use of the FRENIC-Multi. Read them in conjunction with this manual as necessary.

Name	Description
Catalog	Product scope, features, specifications, external drawings, and options of the product
Instruction Manual	Acceptance inspection, mounting & wiring of the inverter, operation using the keypad, running the motor for a test, troubleshooting, and maintenance and inspection

The materials are subject to change without notice. Be sure to obtain the latest editions for use.



Japanese Guideline for Suppressing Harmonics by Customers Receiving High Voltage or Special High Voltage

Refer to this manual, Appendix B for details on this guideline.

Safety precautions

Read this manual and the FRENIC-Multi Instruction Manual thoroughly before proceeding with installation, connections (wiring), operation, or maintenance and inspection. Ensure you have sound knowledge of the product and familiarize yourself with all safety information and precautions before proceeding to operate the inverter.

Safety precautions are classified into the following two categories in this manual.

 WARNING	Failure to heed the information indicated by this symbol may lead to dangerous conditions, possibly resulting in death or serious bodily injuries.
 CAUTION	Failure to heed the information indicated by this symbol may lead to dangerous conditions, possibly resulting in minor or light bodily injuries and/or substantial property damage.

Failure to heed the information contained under the CAUTION title can also result in serious consequences. These safety precautions are of utmost importance and must be observed at all times.

 CAUTION
This product is not designed for use in appliances and machinery on which lives depend. Consult your Fuji Electric representative before considering the FRENIC-Multi series of inverters for equipment and machinery related to nuclear power control, aerospace uses, medical uses or transportation. When the product is to be used with any machinery or equipment on which lives depend or with machinery or equipment which could cause serious loss or damage should this product malfunction or fail, ensure that appropriate safety devices and/or equipment are installed.

■ Precautions for Use

In running general-purpose motors	Driving a 460 V general-purpose motor	When driving a 460 V general-purpose motor with an inverter using extremely long wires, damage to the insulation of the motor may occur. Use an output circuit filter (OFL) if necessary after checking with the motor manufacturer. Fuji motors do not require the use of output circuit filters because of their reinforced insulation.
	Torque characteristics and temperature rise	When the inverter is used to run a general-purpose motor, the temperature of the motor becomes higher than when it is operated using a commercial power supply. In the low-speed range, the cooling effect will be weakened, so decrease the output torque of the motor. If constant torque is required in the low-speed range, use a Fuji inverter motor or a motor equipped with an externally powered ventilating fan.
	Vibration	When an inverter-driven motor is mounted to a machine, resonance may be caused by the natural frequencies of the machine system. Note that operation of a 2-pole motor at 60 Hz or higher may cause abnormal vibration. * The use of a rubber coupling or vibration-proof rubber is recommended. * Use the inverter's jump frequency control feature to skip the resonance frequency zone(s).
	Noise	When an inverter is used with a general-purpose motor, the motor noise level is higher than that with a commercial power supply. To reduce noise, raise carrier frequency of the inverter. Operation at 60 Hz or higher can also result in higher level of wind roaring sound.
In running special motors	High-speed motors	If the reference frequency is set to 120 Hz or more to drive a high-speed motor, test-run the combination of the inverter and motor beforehand to check for safe operation.
	Explosion-proof motors	When driving an explosion-proof motor with an inverter, use a combination of a motor and an inverter that has been approved in advance.
	Submersible motors and pumps	These motors have a higher rated current than general-purpose motors. Select an inverter whose rated output current is higher than that of the motor. These motors differ from general-purpose motors in thermal characteristics. Set a low value in the thermal time constant of the motor when setting the electronic thermal overcurrent protection (for motor).
	Brake motors	For motors equipped with parallel-connected brakes, their power supply for brake must be supplied from the inverter's primary circuit. If the power supply for brake is connected to the inverter's output circuit by mistake, the brake will not work. Do not use inverters for driving motors with series-connected brake coils.
	Geared motors	If the power transmission mechanism uses an oil-lubricated gearbox or speed changer/reducer, then continuous motor operation at low speed may cause poor lubrication. Avoid such operation.
	Synchronous motors	It is necessary to take special measures suitable for this motor type. Contact your Fuji Electric representative for details.
	Single-phase motors	Single-phase motors are not suitable for inverter-driven variable speed operation. Use three-phase motors.

Environmental conditions	Installation location	<p>Use the inverter within the ambient temperature range from -10 to +50°C. The heat sink and braking resistor of the inverter may become hot under certain operating conditions, so install the inverter on nonflammable material such as metal.</p> <p>Ensure that the installation location meets the environmental conditions specified in Chapter 8, Section 8.4 "Operating Environment and Storage Environment."</p>
Combination with peripheral devices	Installing an MCCB or RCD/GFCI	<p>Install a recommended molded case circuit breaker (MCCB) or residual-current-operated protective device (RCD)/ground-fault circuit interrupter (GFCI) (with overcurrent protection) in the primary circuit of each inverter to protect the wiring. Ensure that the circuit breaker capacity is equivalent to or lower than the recommended capacity.</p>
	Installing an MC in the secondary circuit	<p>If a magnetic contactor (MC) is installed in the inverter's output (secondary) circuit for switching the motor to commercial power or for any other purpose, ensure that both the inverter and the motor are completely stopped before you turn the MC on or off.</p> <p>Remove a surge killer integrated with the magnetic contactor in the inverter's output (secondary) circuit.</p>
	Installing an MC in the primary circuit	<p>Do not turn the magnetic contactor (MC) in the primary circuit on or off more than once an hour as an inverter failure may result.</p> <p>If frequent starts or stops are required during motor operation, use terminal [FWD]/[REV] signals or the RUN/STOP key.</p>
	Protecting the motor	<p>The electronic thermal feature of the inverter can protect the motor. The operation level and the motor type (general-purpose motor, inverter motor) should be set. For high-speed motors or water-cooled motors, set a small value for the thermal time constant.</p> <p>If you connect the motor thermal relay to the motor with a long wire, a high-frequency current may flow into the wiring stray capacitance. This may cause the thermal relay to trip at a current lower than the set value. If this happens, lower the carrier frequency or use the output circuit filter (OFL).</p>
	Discontinuance of power-factor correcting capacitor	<p>Do not connect power-factor correcting capacitors to the inverter's primary circuit. (Use the DC reactor to improve the inverter power factor.) Do not use power-factor correcting capacitors in the inverter's output (secondary) circuit. An overcurrent trip will occur, disabling motor operation.</p>
	Discontinuance of surge killer	<p>Do not connect a surge killer to the inverter's output (secondary) circuit.</p>
	Reducing noise	<p>Use of a filter and shielded wires is typically recommended to satisfy EMC Directive.</p> <p>Refer to Appendices, App. A "Advantageous Use of Inverters (Notes on electrical noise)" for details.</p>
	Measures against surge currents	<p>If an overvoltage trip occurs while the inverter is stopped or operated under light load, it is assumed that the surge current is generated by open/close of the phase-advancing capacitor in the power system.</p> <p>* Connect a DC reactor to the inverter.</p>
	Megger test	<p>When checking the insulation resistance of the inverter, use a 500 V megger and follow the instructions contained in the FRENIC-Multi Instruction Manual, Chapter 7, Section 7.5 "Insulation Test."</p>

Wiring	Control circuit wiring length	When using remote control, limit the wiring length between the inverter and operator panel to 20 m or less and use twisted pair or shielded wire.
	Wiring length between inverter and motor	If long wiring is used between the inverter and the motor, the inverter may overheat or trip due to overcurrent because a higher harmonics current flows into the stray capacitance between each phase wire. Ensure that the wiring is shorter than 50 m. If this length must be exceeded, lower the carrier frequency or install an output circuit filter (OFL).
	Wire size	Select wires with a sufficient capacity by referring to the current value or recommended wire size.
	Wire type	Do not share one multi-core cable in order to connect several inverters with motors.
	Grounding	Securely ground the inverter using the grounding terminal.
Selecting inverter capacity	Driving general-purpose motor	Select an inverter according to the nominal applied motor ratings listed in the standard specifications table for the inverter. When high starting torque is required or quick acceleration or deceleration is required, select an inverter with one rank larger capacity than the standard. Refer to Chapter 7, Section 7.1 "Selecting Motors and Inverters" for details.
	Driving special motors	Select an inverter that meets the following condition: Inverter rated current > Motor rated current
Transportation and storage	When transporting or storing inverters, follow the procedures and select locations that meet the environmental conditions listed in the FRENIC-Multi Instruction Manual, Chapter 1, Section 1.3 "Transportation" and Section 1.4 "Storage Environment."	

How this manual is organized

This manual contains Chapters 1 through 9, Appendices and Glossary.

Part 1 General Information

Chapter 1 INTRODUCTION TO FRENIC-Multi

This chapter describes the features and control system of the FRENIC-Multi series, and the recommended configuration for the inverter and peripheral equipment.

Chapter 2 PARTS NAMES AND FUNCTIONS

This chapter contains external views of the FRENIC-Multi series and an overview of terminal blocks, including a description of the LED display and keys on the keypad.

Chapter 3 OPERATION USING THE KEYPAD

This chapter describes inverter operation using the keypad. The inverter features three operation modes (Running, Programming and Alarm modes) which enable you to run and stop the motor, monitor running status, set function code data, display running information required for maintenance, and display alarm data.

Part 2 Driving the Motor

Chapter 4 BLOCK DIAGRAMS FOR CONTROL LOGIC

This chapter describes the main block diagrams for the control logic of the FRENIC-Multi series of inverters.

Chapter 5 RUNNING THROUGH RS-485 COMMUNICATION

This chapter describes an overview of inverter operation through the RS-485 communications facility. Refer to the RS-485 Communication User's Manual or RS-485 Communications Card "OPC-E1-RS" Installation Manual for details.

Part 3 Peripheral Equipment and Options

Chapter 6 SELECTING PERIPHERAL EQUIPMENT

This chapter describes how to use a range of peripheral equipment and options, FRENIC-Multi's configuration with them, and requirements and precautions for selecting wires and crimp terminals.

Part 4 Selecting Optimal Inverter Model

Chapter 7 SELECTING OPTIMAL MOTOR AND INVERTER CAPACITIES

This chapter provides you with information about the inverter output torque characteristics, selection procedure, and equations for calculating capacities to help you select optimal motor and inverter models. It also helps you select braking resistors.

Chapter 8 SPECIFICATIONS

This chapter describes specifications of the output ratings, control system, and terminal functions for the FRENIC-Multi series of inverters. It also provides descriptions of the operating and storage environment, external dimensions, examples of basic connection diagrams, and details of the protective functions.

Chapter 9 FUNCTION CODES

This chapter contains overview lists of seven groups of function codes available for the FRENIC-Multi series of inverters and details of each function code.

Appendices

Glossary

Icons

The following icons are used throughout this manual.



This icon indicates information which, if not heeded, can result in the inverter not operating to full efficiency, as well as information concerning incorrect operations and settings which can result in accidents.



This icon indicates information that can prove handy when performing certain settings or operations.



This icon indicates a reference to more detailed information.

CONTENTS

Part 1 General Information

Chapter 1 INTRODUCTION TO FRENIC-Multi

1.1	Features.....	1-1
1.2	Control System	1-11
1.3	Recommended Configuration	1-13

Chapter 2 PARTS NAMES AND FUNCTIONS

2.1	External View and Allocation of Terminal Blocks.....	2-1
2.2	LED Monitor, Keys and LED Indicators on the Keypad	2-2

Chapter 3 OPERATION USING THE KEYPAD

3.1	Overview of Operation Modes	3-1
3.2	Running Mode	3-3
3.2.1	Monitoring the running status	3-3
3.2.2	Setting up frequency and PID commands	3-4
3.2.3	Running/stopping the motor.....	3-9
3.2.4	Jogging Operation	3-9
3.3	Programming Mode	3-10
3.3.1	Setting up basic function codes quickly -- Menu #0 "Quick Setup" --.....	3-12
3.3.2	Setting up function codes -- Menu #1 "Data Setting" --.....	3-16
3.3.3	Checking changed function codes -- Menu #2 "Data Checking" --	3-17
3.3.4	Monitoring the running status -- Menu #3 "Drive Monitoring" --	3-18
3.3.5	Checking I/O signal status -- Menu #4 "I/O Checking" --	3-21
3.3.6	Reading maintenance information -- Menu #5 "Maintenance Information" --	3-26
3.3.7	Reading alarm information -- Menu #6 "Alarm Information" --	3-29
3.4	Alarm Mode.....	3-32
3.4.1	Releasing the alarm and switching to Running mode	3-32
3.4.2	Displaying the alarm history	3-32
3.4.3	Displaying the status of inverter at the time of alarm	3-32
3.4.4	Switching to Programming mode.....	3-32

Part 2 Driving the Motor

Chapter 4 BLOCK DIAGRAMS FOR CONTROL LOGIC

4.1	Symbols Used in Block Diagrams and their Meanings	4-1
4.2	Drive Frequency Command Block	4-2
4.3	Drive Command Block	4-6
4.4	Control Block.....	4-8
4.5	PID Process Control Block	4-12
4.6	PID Dancer Control Block.....	4-16
4.7	FM Output Selector	4-19

Chapter 5 RUNNING THROUGH RS-485 COMMUNICATION

5.1	Overview on RS-485 Communication.....	5-1
5.1.1	RS-485 common specifications (standard and optional).....	5-2
5.1.2	RJ-45 connector pin assignment for standard RS-485 communications port.....	5-3
5.1.3	Pin assignment for optional RS-485 Communications Card.....	5-4
5.1.4	Cable for RS-485 communications port.....	5-4
5.1.5	Communications support devices.....	5-5
5.2	Overview of FRENIC Loader.....	5-6
5.2.1	Specifications.....	5-6
5.2.2	Connection.....	5-7
5.2.3	Function overview.....	5-7
5.2.3.1	Setting of function code.....	5-7
5.2.3.2	Multi-monitor.....	5-8
5.2.3.3	Running status monitor.....	5-9
5.2.3.4	Test-running.....	5-10
5.2.3.5	Real-time trace—Displaying running status of an inverter in waveforms.....	5-11

Part 3 Peripheral Equipment and Options

Chapter 6 SELECTING PERIPHERAL EQUIPMENT

6.1	Configuring the FRENIC-Multi.....	6-1
6.2	Selecting Wires and Crimp Terminals.....	6-2
6.2.1	Recommended wires.....	6-4
6.3	Peripheral Equipment.....	6-8
6.4	Selecting Options.....	6-14
6.4.1	Peripheral equipment options.....	6-14
6.4.2	Options for operation and communications.....	6-23
6.4.3	Meter options.....	6-26

Part 4 Selecting Optimal Inverter Model

Chapter 7 SELECTING OPTIMAL MOTOR AND INVERTER CAPACITIES

7.1	Selecting Motors and Inverters.....	7-1
7.1.1	Motor output torque characteristics.....	7-1
7.1.2	Selection procedure.....	7-4
7.1.3	Equations for selections.....	7-7
7.1.3.1	Load torque during constant speed running.....	7-7
7.1.3.2	Acceleration and deceleration time calculation.....	7-8
7.1.3.3	Heat energy calculation of braking resistor.....	7-11
7.1.3.4	Calculating the RMS rating of the motor.....	7-12
7.2	Selecting a Braking Resistor.....	7-13
7.2.1	Selection procedure.....	7-13
7.2.2	Notes on selection.....	7-13

Chapter 8 SPECIFICATIONS

8.1	Standard Models	8-1
8.1.1	Three-phase 230 V	8-1
8.1.2	Three-phase 460 V	8-2
8.1.3	Single-phase 230 V	8-3
8.2	Common Specifications	8-4
8.3	Terminal Specifications	8-8
8.3.1	Terminal functions	8-8
8.3.2	Terminal arrangement diagram and screw specifications.....	8-19
8.3.2.1	Main circuit terminals	8-19
8.3.2.2	Control circuit terminals.....	8-20
8.4	Operating Environment and Storage Environment	8-21
8.4.1	Operating environment.....	8-21
8.4.2	Storage environment	8-22
8.4.2.1	Temporary storage.....	8-22
8.4.2.2	Long-term storage	8-22
8.5	External Dimensions.....	8-23
8.5.1	Standard models	8-23
8.5.2	Standard keypad	8-26
8.6	Connection Diagrams	8-27
8.6.1	Running the inverter with keypad	8-27
8.6.2	Running the inverter by terminal commands	8-28
8.7	Protective Functions	8-30

Chapter 9 FUNCTION CODES

9.1	Function Code Tables	9-1
9.2	Overview of Function Codes	9-14
9.2.1	F codes (Fundamental functions)	9-14
9.2.2	E codes (Extension terminal functions).....	9-43
9.2.3	C codes (Control functions)	9-70
9.2.4	P codes (Motor 1 parameters)	9-77
9.2.5	H codes (High performance functions)	9-80
9.2.6	A codes (Motor 2 parameters).....	9-102
9.2.7	J codes (Application functions).....	9-104
9.2.8	y codes (Link functions).....	9-119

Appendices

App.A	Advantageous Use of Inverters (Notes on electrical noise).....	A-1
A.1	Effect of inverters on other devices	A-1
A.2	Noise.....	A-2
A.3	Noise prevention.....	A-4
App.B	Effect on Insulation of General-purpose Motors Driven with 460 V Class Inverters.....	A-12
B.1	Generating mechanism of surge voltages	A-12
B.2	Effect of surge voltages	A-13
B.3	Countermeasures against surge voltages	A-13
B.4	Regarding existing equipment	A-14
App.C	Inverter Generating Loss	A-15
App.D	Conversion from SI Units.....	A-16
App.E	Allowable Current of Insulated Wires	A-18
App.F	Replacement Information	A-20
F.1	External dimensions comparison tables.....	A-20
F.2	Terminal arrangements and symbols	A-23
F.3	Function codes.....	A-26

Glossary

Part 1 General Information



Chapter 1 INTRODUCTION TO FRENIC-Multi

Chapter 2 PARTS NAMES AND FUNCTIONS

Chapter 3 OPERATION USING THE KEYPAD

Chapter 1

INTRODUCTION TO FRENIC-Multi

This chapter describes the features and control system of the FRENIC-Multi series and the recommended configuration for the inverter and peripheral equipment.

Contents

1.1	Features	1-1
1.2	Control System.....	1-11
1.3	Recommended Configuration	1-13

1.1 Features

Environment-friendly

■ Complies with European regulations that limit the use of specific hazardous substances (RoHS)

These inverters are gentle on the environment.

Use of 6 hazardous substances is limited. (Products manufactured beginning in the autumn of 2005 will comply with European regulations (except for interior soldering in the power module.))

<Six Hazardous Substances>

Lead, Mercury, Cadmium, Hexavalent Chromium, Polybrominated biphenyl (PBB), Polybrominated diphenyl ether (PBDE)

<About RoHS>

The Directive 2002/95/EC, promulgated by the European Parliament and European Council, limits the use of specific hazardous substances included in electrical and electronic devices.

■ Long-life design

The design life of each internal component with limited life has been extended to 10 years. This helps to extend the maintenance cycle for your equipment.

Limited Life Component	Service Life
Main circuit capacitors	10 years
Electrolytic capacitors on printed circuit boards	10 years
Cooling fan	10 years

Conditions: Ambient temperature is 40°C (104°F) and load factor is 80% of the inverter's rated current.

■ Noise is reduced by the built-in EMC filter

Use of a built-in EMC filter that reduces noise generated by the inverter makes it possible to reduce the effect on peripheral equipment.

Expanded capacity range and abundant model variation

■ Standard Series

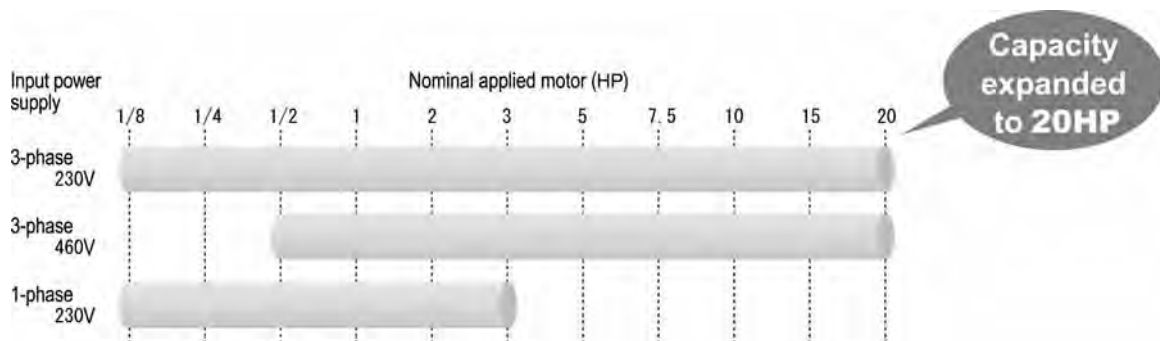

Figure 1.1

■ **Semi-standard Series**

- Models with built-in EMC filter
- Models with built-in PG interface card
- Models with built-in RS-485 communications card
- Models for synchronous motors



Figure 1.2

The highest standards of control and performance in its class

■ **Shortened setting time in slip compensation control**

Through "slip compensation control" + "voltage tuning," speed control accuracy at low speeds is improved. This minimizes variations in speed control accuracy at times when the load varies, and since the time at creep speeds is shortened, single cycle tact times can be shortened.

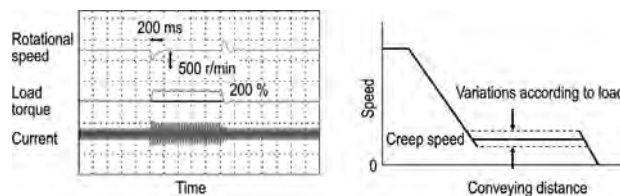

Figure 1.3

■ **Equipped with the highest level CPU for its class**

The highest level CPU of any inverter is used. Computation and processing capacity is doubled over the previous inverter, improving speed control accuracy.

CPU speed comparison



Figure 1.4

■ **Compatible with PG feedback control**

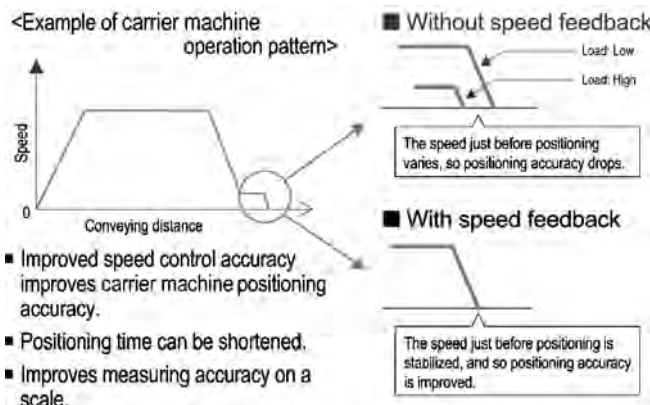

Figure 1.5

■ Tripless deceleration by automatic deceleration control

The inverter controls the energy level generated and the deceleration time, and so deceleration stop can be accomplished without tripping due to overvoltage.

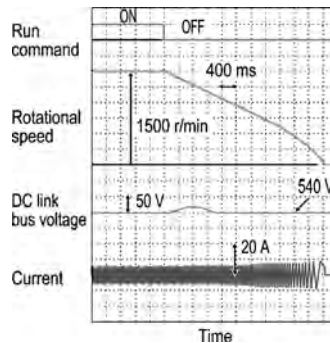

Figure 1.6

Optimum for the operations specific to vertical and horizontal conveyance

■ Hit-and-stop control is realized more easily

Impacts are detected mechanically and not only can the inverter's operation pattern be set on coast-to-stop or deceleration stop, but switching from torque limitation to current limitation and generating a holding torque (hit-and-stop control) can be selected, making it easy to adjust brake application and release timing.

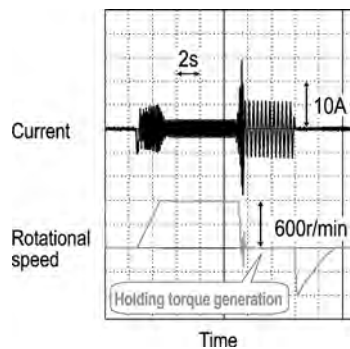

Figure 1.7

■ Inclusion of a brake signal makes it even more convenient

At brake release time

After the motor operates, torque generation is detected and signals are output.

At brake application time

Brake application that matches the timing can be done, and so mechanical brake wear is reduced.

■ **Limit operations can be selected to match your equipment**

Inverters are equipped with two limit operations, "torque limitation" and "current limitation," so either can be selected to match the equipment you are using the inverter with.

Torque limitation

In order to protect mechanical systems, this function accurately limits the torque generated by the motor. (Instantaneous torque cannot be limited.)

Current limitation

This function limits the current flowing to the motor to protect the motor thermally or to provide rough load limitation. (Instantaneous current cannot be limited. Auto tuning is not required.)

Simple and thorough maintenance

■ **The life information on each of the inverter's limited life components is displayed**

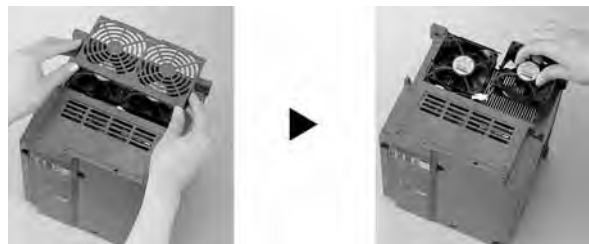

Figure 1.8

■ **Simple cooling fan replacement**

Construction is simple, enabling quick removal of the top cover and making it easy to replace the cooling fan. (7.5 HP or higher models)

Cooling fan replacement procedure



The cover on top of the inverter can be quickly removed.

Simply disconnect the power connector and replace the cooling fan.

Figure 1.9

■ **Information that contributes to equipment maintenance is displayed**

In addition to inverter maintenance information, data that also take equipment maintenance into consideration are displayed.

Item	Purpose
Motor cumulative running time (hr)	The actual cumulative running time of the equipment (motor) the inverter is being used with is calculated. <Example of use> If the inverter is used to control a fan, this information is an indication of the timing for replacing the belt that is used on the pulleys.
Number of starts (times)	The number of times the inverter starts and stops can be counted. <Example of use> The number of equipment starts and stops is recorded, and so this information can be used as a guideline for parts replacement timing in equipment in which starting and stopping puts a heavy load on the machinery.

- **The alarm history records the latest four incidents**

Detailed information can be checked for the four most recent alarms.

Simple operation, simple wiring

- **A removable keypad is standard equipment**

The keypad can be easily removed and reset, making remote operation possible. If the back cover packed with the inverter is installed and a LAN cable is used, the keypad can be easily mounted on the equipment's control panel.



Figure 1.10

- **A removable interface board is used**

The interface board is used as a terminal block for control signals. Since it is removable, wiring operations are simple.



Figure 1.11

All types and variations of interface board are available as options (available soon). Optional interface boards have the same dimensions as the standard interface board supplied with the inverter, so it is possible to meet optional specifications using the same installation space as with standard specification models.

■ **A multi-function keypad which enables a wide variety of operations is available**

A multi-function keypad is available as an option. This keypad features a large 7-segment LED with five digits and large backlit liquid crystal panel. Its view-ability is high, and guidance is displayed on the liquid crystal panel, therefore operations can be conducted simply. (A copy function is included.)



Figure 1.12

■ **Inverter support loader software is available (On sale soon)**

Windows compatible loader software is available to simplify the setting and management of function codes.

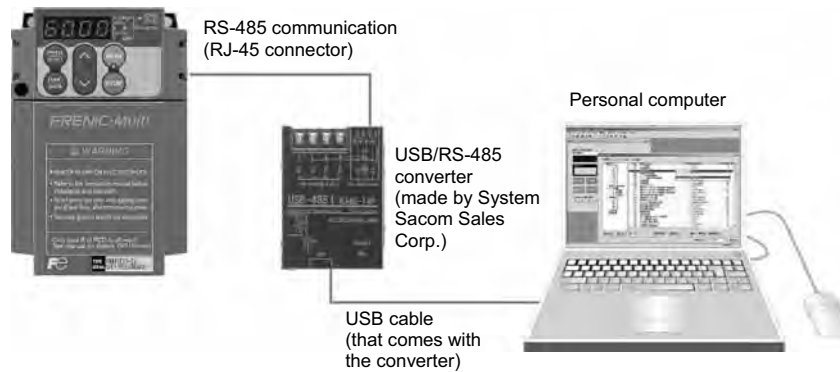

Figure 1.13

■ **Simulated failure enables peripheral device operation checks**

The inverter has the function for outputting dummy alarm signals, enabling simple checking of sequence operations of peripheral devices from the control panel where the inverter is used.

Consideration of peripheral equipment, and a full range of protective functions

■ **Side-by-side mounting saves space**

If your control panel is designed to use multiple inverters, these inverters make it possible to save space through their horizontal side-by-side installation. (5 HP or smaller models)



Figure 1.14

■ **Resistors for suppressing inrush current are built in, making it possible to reduce the capacity of peripheral equipment**

When FRENIC-Multi Series (including FRENIC-Mini Series, FRENIC-Eco Series and 11 Series) is used, the built-in resistor suppresses the inrush current generated when the motor starts. Therefore, it is possible to select peripheral equipment with lower capacity when designing your system than the equipment needed for direct connection to the motor.

■ **Outside panel cooling is also made possible using**

the mounting adapter for external cooling (option). The mounting adapter for external cooling (option) can be installed easily as an outside panel cooling system. This function is standard on 7.5 HP or higher models.

You can use an inverter equipped with functions like these

■ **New system for more energy-efficient operation**

Previous energy saving operation functions worked only to control the motor's loss to keep it at a minimum in accordance with the load condition. In the newly developed FRENIC-Multi Series, the focus has been switched away from the motor alone to both the motor and the inverter as electrical products. As a result, we incorporated a new control system (optimum and minimum power control) that minimizes the power consumed by the inverter itself (inverter loss) and the loss of the motor.

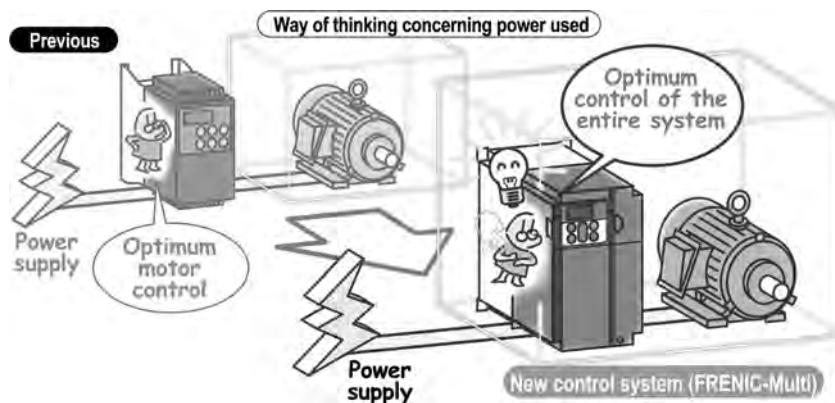

Figure 1.15

■ **Smooth starts through the auto search**

In the case where a fan is not being run by the inverter but is turning free, the fan's speed is checked, regardless of its rotational direction, and operation of the fan is picked up to start the fan smoothly. This function is convenient in such cases as when switching instantaneously from commercial power supply to the inverter.

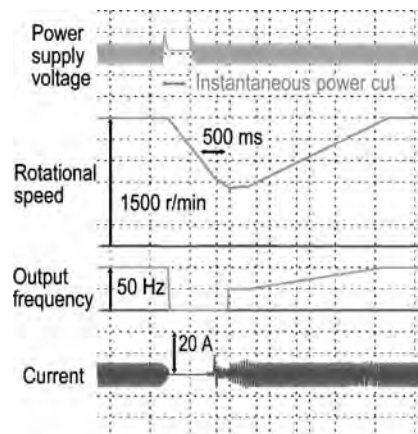

Figure 1.16

■ Equipped with a full range of PID control functions

Differential alarm and absolute value alarm outputs have been added for PID regulator which carry out process controls such as temperature, pressure and flowrate control. In addition, an anti-reset windup function to prevent PID control overshoot and other PID control functions which can be adjusted easily through PID output limiter, integral hold/reset signals are provided. The PID output limiter and integral hold/reset signals can also be used in cases where the inverter is used for dancer control.

■ Operating signal trouble is avoided by the command loss detection function

If frequency signals connected to the inverter (0 to 10 V, 4 to 20 mA, Multi-speed signals, communications, etc.) are interrupted, the missing frequency commands are detected as a "command loss." Further, the frequency that is output when command loss occurs can be set in advance, so operation can be continued even in cases where the frequency signal lines are cut due to mechanical vibrations of the equipment, etc.

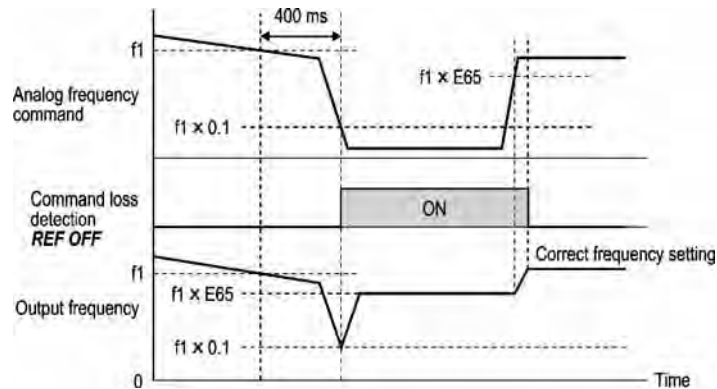

Figure 1.17

■ An overload stop function protects equipment from over-operation

If the load on equipment suddenly becomes great while controlled by the inverter, the inverter can be switched to deceleration stop or to coast-to-stop operation to prevent damage to the equipment.

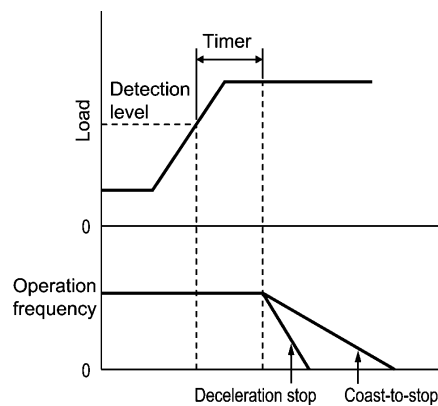

Figure 1.18

■ Continuous equipment operation with overload avoidance control

If the fans or pulleys are entangled with foreign material so as to increase the load and cause a sudden temperature rise in the inverter or if the ambient temperature abnormally rises, then the inverter becomes overloaded so that it reduces the motor speed to lessen the load for continuing operation.

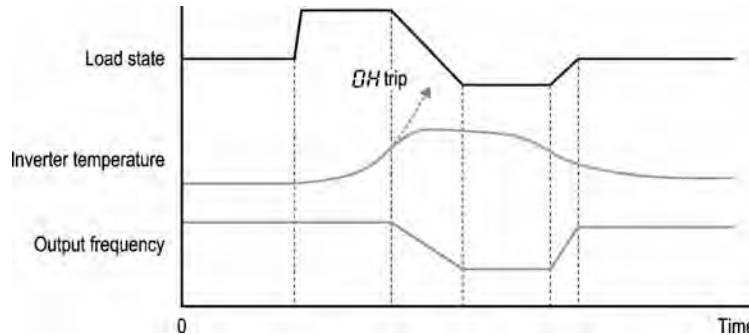

Figure 1.19

Fully compatible with network operation

■ RS-485 communications (connector) is standard

A connector (RJ-45) compatible with RS-485 communication is provided as standard (1 port, also used for keypad communication), so the inverter can be connected easily using an off-the-shelf LAN cable (10BASE-T/100BASE-TX).



Figure 1.20

■ **Complies with optional networks using option cards (Available soon)**

Installation of special interface cards (option) makes it possible to connect to the following networks.

- DeviceNet
- PROFIBUS-DP
- CC-Link

■ **Wiring is easy with the RS-485 communications card (optional)**

The RS-485 communications card is available as an option. It has a pair of RJ-45 connectors that acts as a transfer port for a multidrop network configuration, independently of the communications port (RJ-45) provided as standard on the inverter.

Important points

- (1) A pair of RJ-45 connectors, eliminating the provision of a separate multidrop adaptor.
- (2) Built-in terminating resistor, eliminating the provision of a separate terminating resistor.

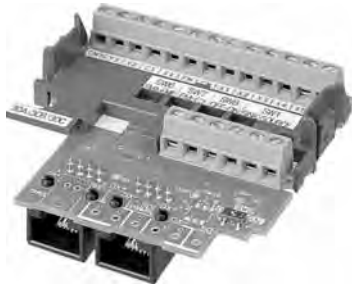

Figure 1.21 RS-485 Communications Card (option)

Example of configuration with peripheral equipment

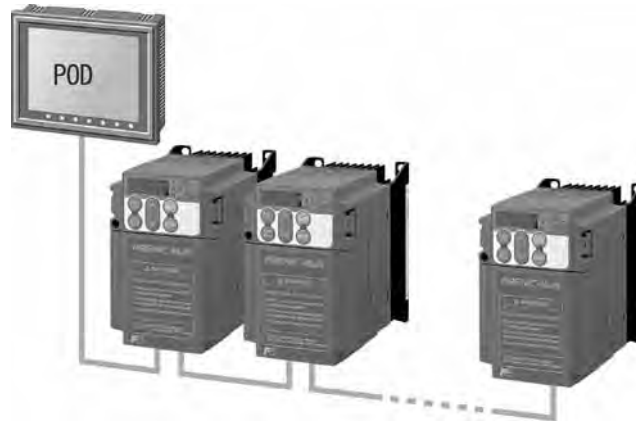
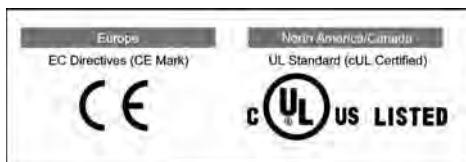

Figure 1.22 Inverters Totally Controlled by POD

Global standard compliance



- Complies with standards
- Sink/Source switchable
- Wide voltage range
- The multi-function keypad displays multiple languages (Japanese, English, German, French, Spanish, Italian, Chinese, and Korean).

* There are two types of multi-function keypad.

1.2 Control System

This section gives you a general overview of inverter control systems and features specific to the FRENIC-Multi series of inverters.

As shown in Figure 1.24, the converter section converts the input commercial power to DC power by means of a full-wave rectifier, which charges the DC link bus capacitor (reservoir capacitor). The inverter portion modulates the electric energy charged in the DC link bus capacitor by Pulse Width Modulation (PWM) according to the control circuit signals and feeds the output to the motor. (The PWMed frequency is called the "Carrier Frequency.")

The voltage applied to the motor has a waveform modulated by the carrier frequency from the dynamic torque vector flux controller that estimates the optimal PWM signal monitoring the inverter output current feedback, as shown on the left-hand side ("PWM voltage waveform") of Figure 1.23. The voltage consists of alternating cycles of positive and negative pulse trains synchronizing with the inverter's output frequency.

The current running through the motor, on the other hand, has a fairly smooth alternating current (AC) waveform shown on the right-hand side ("Current waveform") of Figure 1.23, thanks to the inductance of the motor coil. The control block section controls the PWM so as to bring this current waveform as close to a sinusoidal waveform as possible.

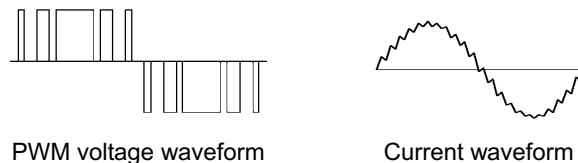

Figure 1.23 Output Voltage and Current Waveform of the Inverter

For the reference frequency given in the control block, the accelerator/decelerator processor calculates the acceleration/deceleration rate required by run/stop control of the motor and transfers the calculated results to the voltage calculator directly or via the dynamic torque vector flux controller, whose output drives the PWM block to switch the power gates.

The FRENIC-Multi series features the dynamic torque vector controller with the flux estimator, which is always correcting the magnetic flux phase while monitoring the inverter output current as the feedback. This feature allows the inverter to always apply the drive power with an optimal voltage and current and consequently respond to quick load variation or speed change.

The feature also estimates the generated torque of the motor from the estimated flux data and output current to the motor to improve the motor efficiency for matching the current operation situation

The control block section, which is the very brain of the inverter, allows you to customize the inverter's driving patterns throughout the function code data settings.

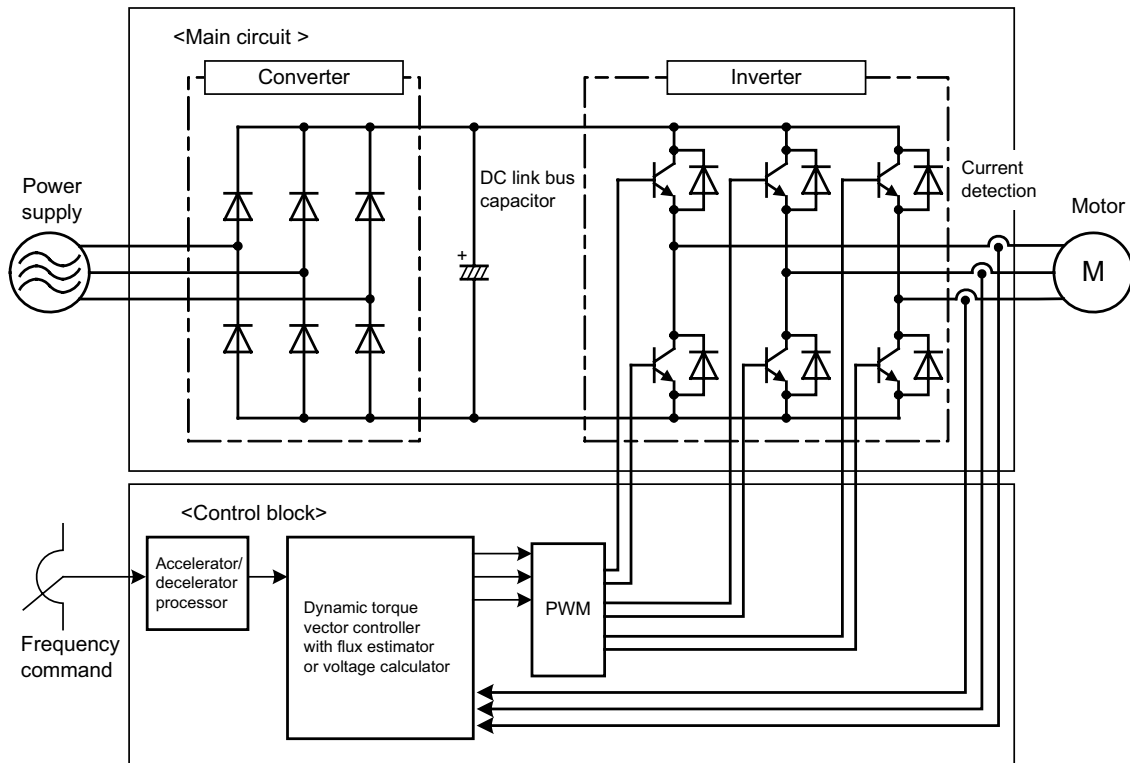

Figure 1.24 Schematic Overview Block Diagram of FRENIC-Multi

1.3 Recommended Configuration

To control a motor with an inverter correctly, you should consider the rated capacity of both the motor and the inverter and ensure that the combination matches the specifications of the machine or system to be used.

After selecting the rated capacities, select appropriate peripheral equipment for the inverter, then connect them to the inverter.

Figure 1.25 shows the recommended configuration for an inverter and peripheral equipment.

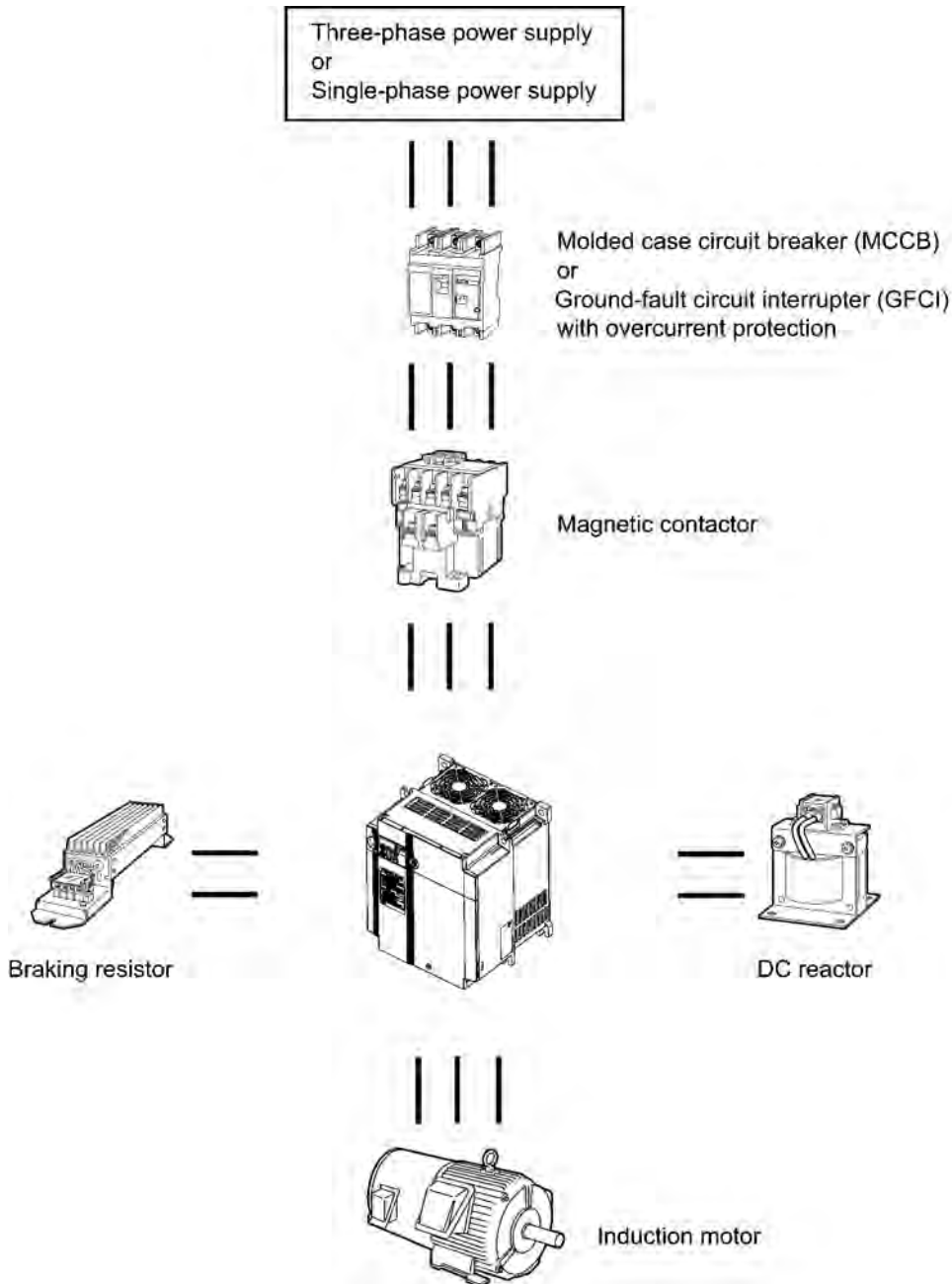

Figure 1.25 Recommended Configuration Diagram

Chapter 2

PARTS NAMES AND FUNCTIONS

This chapter contains external views of the FRENIC-Multi series and an overview of terminal blocks, including a description of the LED monitor, keys and LED indicators on the keypad.

Contents

2.1	External View and Allocation of Terminal Blocks.....	2-1
2.2	LED Monitor, Keys and LED Indicators on the Keypad	2-2

2.1 External View and Allocation of Terminal Blocks

Figure 2.1 shows the external views of the FRENIC-Multi.

(1) External views

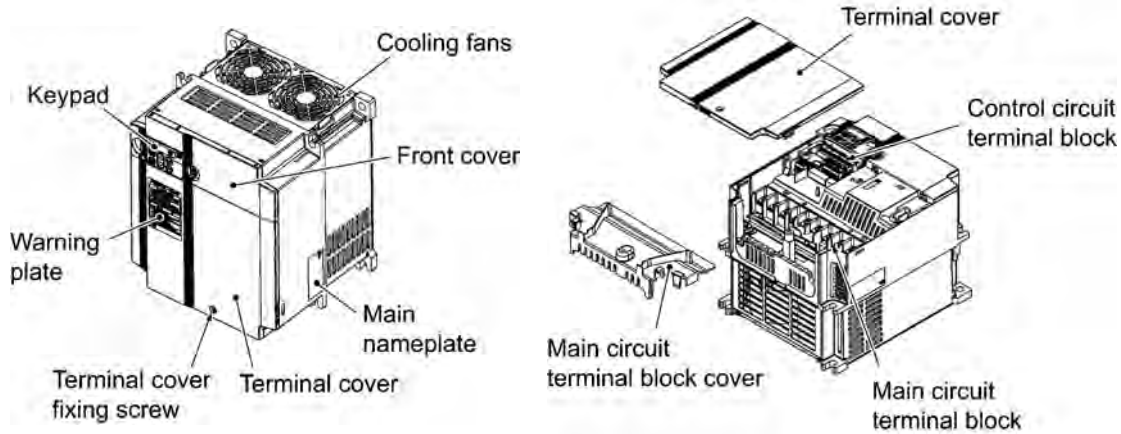

Figure 2.1 FRN020E1S-2U

(2) Terminal block location

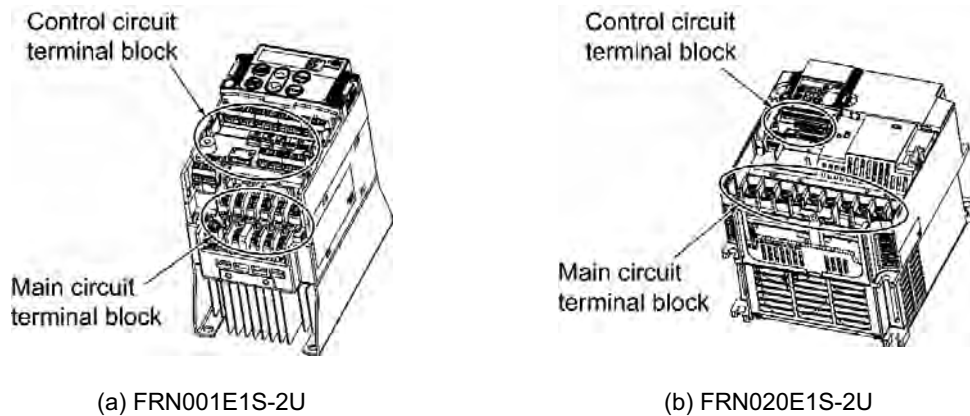



Figure 2.2 Terminal Blocks

-  Refer to Chapter 8 "SPECIFICATIONS" for details on terminal functions, arrangement and connection and to Chapter 6, Section 6.2.1 "Recommended wires" when selecting wires.
-  For details on the keys and their functions, refer to Section 2.2 "LED Monitor, Keys and LED Indicators on the Keypad." For details on keying operation and function code setting, refer to Chapter 3 "OPERATION USING THE KEYPAD."

2.2 LED Monitor, Keys and LED Indicators on the Keypad

As shown at the right, the keypad consists of a four-digit LED monitor, six keys, and five LED indicators.

The keypad allows you to run and stop the motor, monitor running status, and switch to the menu mode. In the menu mode, you can set the function code data, monitor I/O signal states, maintenance information, and alarm information.

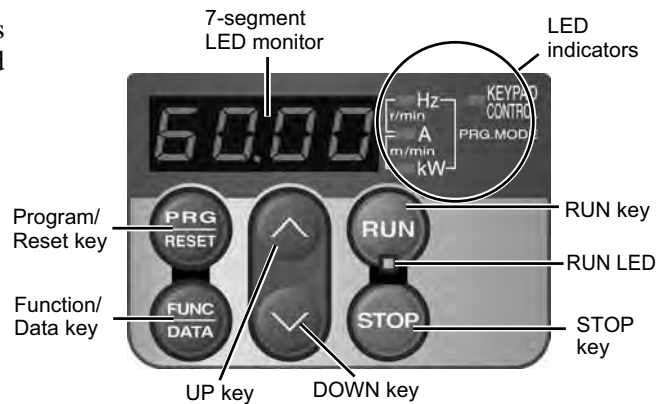

Figure 2.3 Keypad

Table 2.1 Overview of Keypad Functions

Item	LED Monitor, Keys, and LED Indicators	Functions
LED Monitor		<p>Four-digit, 7-segment LED monitor which displays the followings according to the operation modes.</p> <ul style="list-style-type: none"> ■ In Running mode: Running status information (e.g., output frequency, current, and voltage) ■ In Programming mode: Menus, function codes and their data ■ In Alarm mode: Alarm code, which identifies the alarm factor if the protective function is activated.
Operation Keys		<p>Program/Reset key which switches the operation modes of the inverter.</p> <ul style="list-style-type: none"> ■ In Running mode: Pressing this key switches the inverter to Programming mode. ■ In Programming mode: Pressing this key switches the inverter to Running mode. ■ In Alarm mode: Pressing this key after removing the alarm factor will switch the inverter to Running mode.
		<p>Function/Data key which switches the operation you want to do in each mode as follows:</p> <ul style="list-style-type: none"> ■ In Running mode: Pressing this key switches the information to be displayed concerning the status of the inverter (output frequency (Hz), output current (A), output voltage (V), etc.). ■ In Programming mode: Pressing this key displays the function code and sets the data entered with and . ■ In Alarm mode: Pressing this key displays the details of the problem indicated by the alarm code that has come up on the LED monitor.
		RUN key. Press this key to run the motor.
		STOP key. Press this key to stop the motor.
		UP and DOWN keys. Press these keys to select the setting items and change the function code data displayed on the LED monitor.
LED Indicators	RUN LED	Lights when any run command to the inverter is active.
	KEYPAD CONTROL LED	Lights when the inverter is ready to run with a run command entered by the key. (F02 = 0, 2, or 3) In Programming and Alarm modes, you cannot run the inverter even if the indicator lights.
	Unit and mode expression by the three LED indicators	<p>The three LED indicators identify the unit of numeral displayed on the LED monitor in Running mode by combination of lit and unlit states of them.</p> <p>Unit: kW, A, Hz, r/min and m/min</p> <p>Refer to Chapter 3, Section 3.2.1 "Monitoring the running status" for details.</p> <p>While the inverter is in Programming mode, the LEDs of Hz and kW light.</p> <ul style="list-style-type: none"> ■ Hz □ A ■ kW

■ LED monitor

In Running mode, the LED monitor displays running status information (output frequency, current or voltage); in Programming mode, it displays menus, function codes and their data; and in Alarm mode, it displays an alarm code which identifies the alarm factor if the protective function is activated.

If one of LED4 through LED1 is blinking, it means that the cursor is at this digit, allowing you to change it.

If the decimal point of LED1 is blinking, it means that the currently displayed data is a value of the PID process command, not the frequency data usually displayed.

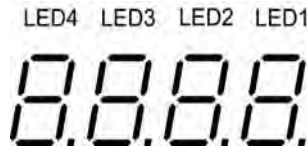

Figure 2.4 7-Segment LED Monitor

Table 2.2 Alphanumeric Characters on the LED Monitor

Character	7-segment	Character	7-segment	Character	7-segment	Character	7-segment
0	0	9	9	i	,	r	r
1	1	A	A	J	J	S	S
2	2	b	b	K	K	T	T
3	3	C	C	L	L	u	u
4	4	d	d	M	M	v	v
5	5	E	E	n	n	W	W
6	6	F	F	o	o	X	X
7	7	G	G	P	P	y	y
8	8	H	H	q	q	Z	Z
Special characters and symbols (numbers with decimal point, minus and underscore)							
0. - 9.	0. - 9.	-	-	_	-		

■ Simultaneous keying

Simultaneous keying means pressing two keys at the same time. The FRENIC-Multi supports simultaneous keying as listed below. The simultaneous keying operation is expressed by a "+" letter between the keys throughout this manual.

(For example, the expression "STOP + ^ keys" stands for pressing the ^ key while holding down the STOP key.)

Table 2.3 Simultaneous Keying

Operation mode	Simultaneous keying	Used to:
Programming mode	STOP + ^ keys	Change certain function code data. (Refer to codes F00, H03, H45, and H97 in Chapter 9 "FUNCTION CODES.")
	STOP + v keys	
Alarm mode	STOP + PRC keys	Switch to Programming mode without resetting alarms currently occurred.

Chapter 3

OPERATION USING THE KEYPAD

This chapter describes inverter operation using the keypad. The inverter features three operation modes (Running, Programming and Alarm modes) which enable you to run and stop the motor, monitor running status, configure function code data, display running information required for maintenance, and display alarm data.

The keypad is available in two types: standard keypad and optional multi-function keypad. For the instructions on how to operate the multi-function keypad, refer to the "Multi-function Keypad Instruction Manual."

Contents

3.1	Overview of Operation Modes.....	3-1
3.2	Running Mode	3-3
3.2.1	Monitoring the running status	3-3
3.2.2	Setting up frequency and PID commands	3-4
3.2.3	Running/stopping the motor.....	3-9
3.2.4	Jogging Operation	3-9
3.3	Programming Mode	3-10
3.3.1	Setting up basic function codes quickly -- Menu #0 "Quick Setup" --.....	3-12
3.3.2	Setting up function codes -- Menu #1 "Data Setting" --.....	3-16
3.3.3	Checking changed function codes -- Menu #2 "Data Checking" --	3-17
3.3.4	Monitoring the running status -- Menu #3 "Drive Monitoring" --	3-18
3.3.5	Checking I/O signal status -- Menu #4 "I/O Checking" --	3-21
3.3.6	Reading maintenance information -- Menu #5 "Maintenance Information" --	3-26
3.3.7	Reading alarm information -- Menu #6 "Alarm Information" --.....	3-29
3.4	Alarm Mode	3-32
3.4.1	Releasing the alarm and switching to Running mode	3-32
3.4.2	Displaying the alarm history	3-32
3.4.3	Displaying the status of inverter at the time of alarm	3-32
3.4.4	Switching to Programming mode.....	3-32

3.1 Overview of Operation Modes

FRENIC-Multi features the following three operation modes:

- **Running mode** : This mode allows you to enter run/stop commands in regular operation. You can also monitor the running status in real time.
- **Programming mode** : This mode allows you to configure function code data and check a variety of information relating to the inverter status and maintenance.
- **Alarm mode** : If an alarm condition arises, the inverter automatically enters Alarm mode. In this mode, you can view the corresponding alarm code* and its related information on the LED monitor.

* Alarm code: Indicates the cause of the alarm condition that has triggered a protective function. For details, refer to Chapter 8, Section 8.7 "Protective Functions."

Figure 3.1 shows the status transition of the inverter between these three operation modes. If the inverter is turned ON, it automatically enters Running mode, making it possible to start or stop the motor.

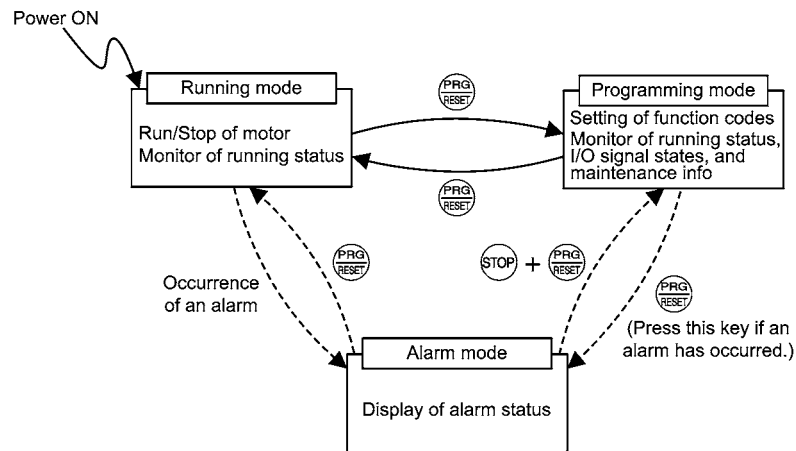
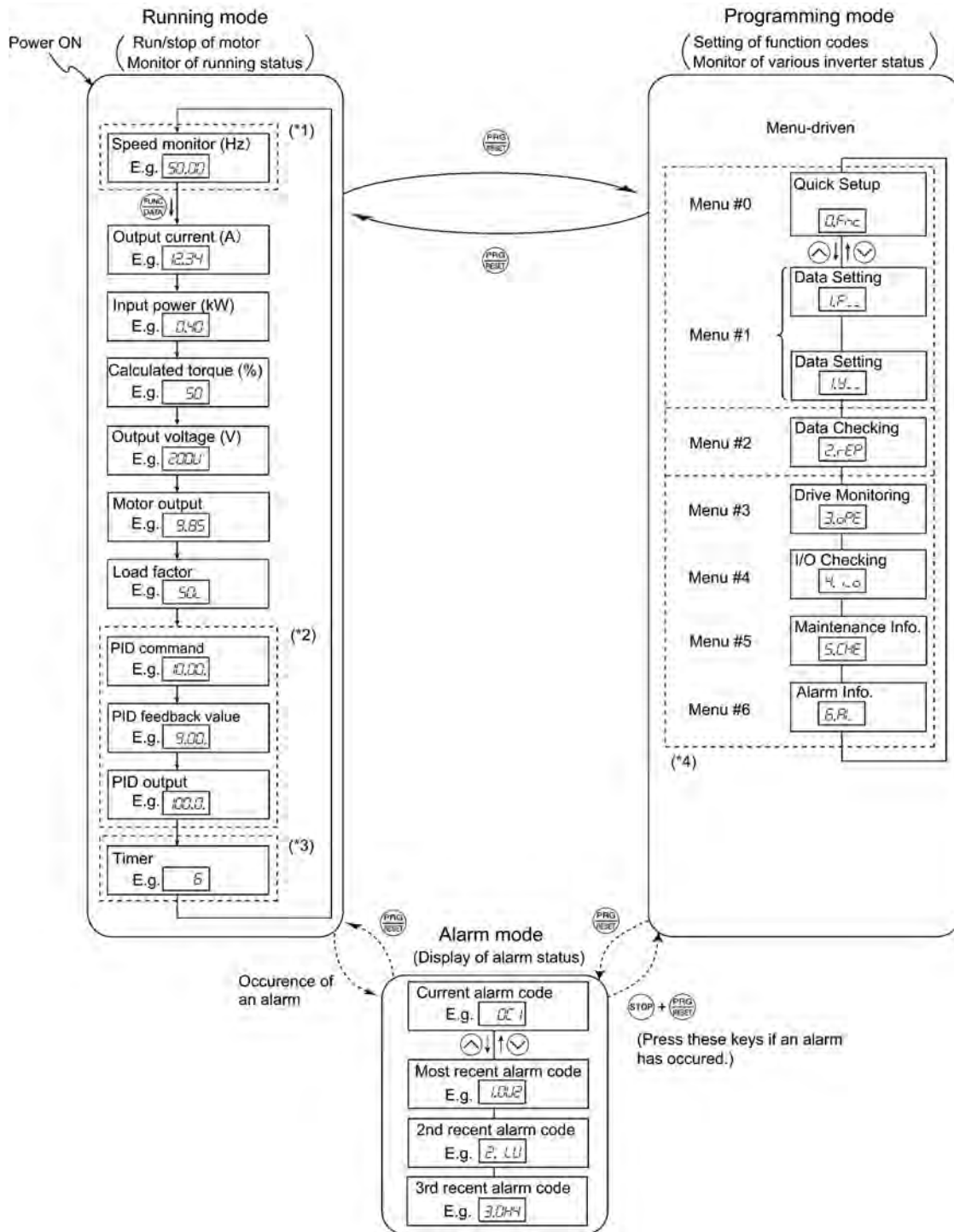

Figure 3.1 Status Transition between Operation Modes

Figure 3.2 illustrates the transition of the LED monitor screen during Running mode, the transition between menu items in Programming mode, and the transition between alarm codes at different occurrences in Alarm mode.



- (*1) The speed monitor allows you to select the desired one from the seven speed monitor items by using function code E48.
- (*2) Applicable only when PID control is active (J01 = 1, 2 or 3).
- (*3) The Timer screen appears only when the timer operation is enabled with function code C21.
- (*4) Applicable only when the full-menu mode is selected (E52 = 2).

Figure 3.2 Transition between Basic Screens in Individual Operation Mode

3.2 Running Mode

When the inverter is turned on, it automatically enters Running mode in which you can:

- (1) Monitor the running status (e.g., output frequency and output current),
- (2) Configure the reference frequency and other settings,
- (3) Run/stop the motor, and
- (4) Jog (inch) the motor.

3.2.1 Monitoring the running status



In Running mode, the eleven items listed below can be monitored. Immediately after the inverter is turned on, the monitor item specified by function code E43 is displayed. Press the  key to switch between monitor items. For details of switching the monitor item by using the  key, refer to "Monitor of running status" in the Running mode in Figure 3.2.

Table 3.1 Monitoring Items

Monitor items	Display sample on the LED monitor *1	LED indicator ■: on, □: off	Unit	Meaning of displayed value	Function code data for E43
Speed monitor	Function code E48 specifies what to be displayed on the LED monitor and LED indicators.				0
Output frequency (before slip compensation)	50.00	■Hz □A □kW	Hz	Frequency actually being output	(E48 = 0)
Output frequency (after slip compensation)	50.00	■Hz □A □kW	Hz	Frequency actually being output	(E48 = 1)
Reference frequency	50.00	■Hz □A □kW	Hz	Reference frequency being set	(E48 = 2)
Motor speed	1500	■Hz ■A □kW	r/min	Output frequency (Hz) × $\frac{120}{P01}$ For motor 2, read P01 as A15.	(E48 = 3)
Load shaft speed	300.0	■Hz ■A □kW	r/min	Output frequency (Hz) × E50	(E48 = 4)
Line speed	300.0	□Hz ■A ■kW	m/min	Output frequency (Hz) × E50	(E48 = 5)
Constant feeding rate time	50	□Hz □A □kW	min	$\frac{E50}{\text{Output frequency (Hz)} \times E39}$	(E48 = 6)
Output current	12.34	□Hz ■A □kW	A	Current output from the inverter in RMS	3
Output voltage *2	200.0	□Hz □A □kW	V	Voltage output from the inverter in RMS	4
Calculated torque	50	□Hz □A □kW	%	Motor output torque in % (Calculated value)	8
Input power	10.25	□Hz □A ■kW	kW	Input power to the inverter	9
PID command *3, *4	10.00	□Hz □A □kW	—	PID command/feedback amount transformed to that of virtual physical value of the object to be controlled (e.g. temperature) Refer to function codes E40 and E41 for details.	10
PID feedback amount *3, *5	9.00	□Hz □A □kW	—		12
Timer (Timer operation) *3	50	□Hz □A □kW	min	Remaining time of timer operation	13
PID output *3, *4	100.0	□Hz □A □kW	%	PID output in % as the maximum frequency (F03) being at 100% For motor 2, read F03 as A01.	14
Load factor *6	50	□Hz □A □kW	%	Load factor of the motor in % as the rated output being at 100%	15
Motor output *7	9.85	□Hz □A ■kW	kW	Motor output in kW	16

-
- *1 A value exceeding 9999 cannot be displayed on the 4-digit LED monitor screen, so "E 3" appear instead.
 - *2 When the LED monitor displays an output voltage, the 7-segment letter \angle in the lowest digit stands for the unit of the voltage "V."
 - *3 These PID-related items appear only when the inverter PID-controls the motor according to a PID command specified by function code J01 (=1, 2 or 3).
The Timer item appears only when the timer operation is enabled with function code C21. (Refer to Chapter 9, Section 9.2.3 "C codes (Control Functions)".)
When the PID control or timer operation is disabled, "----" appear.
 - *4 When the LED monitor displays a PID command or its output amount, the dot (decimal point) attached to the lowest digit of the 7-segment letter blinks.
 - *5 When the LED monitor displays a PID feedback amount, the dot (decimal point) attached to the lowest digit of the 7-segment letter lights.
 - *6 When the LED monitor displays a load factor, the 7-segment letter \angle in the lowest digit stands for "%."
 - *7 When the LED monitor displays the motor output, the unit LED indicator "kW" blinks.

3.2.2 Setting up frequency and PID commands

You can set up the desired frequency and PID commands by using \wedge and \vee keys on the keypad. It is also possible to set up the frequency command as load shaft speed, motor speed or speed (%) by setting function code E48.

■ Setting up a frequency command

Using \wedge and \vee keys (Factory default)

- (1) Set function code F01 to "0: \wedge / \vee keys on keypad." This can be done only when the inverter is in Running mode.
- (2) Press the \wedge / \vee key to display the current reference frequency. The lowest digit will blink.
- (3) If you need to change the frequency command, press the \wedge / \vee key again. The new setting will be automatically saved into the inverter's internal memory and retained even when the power is off. When the power is turned on next time, the setting will be used as an initial reference frequency.



- If you have set function code F01 to "0: \wedge / \vee keys on keypad" but have selected a frequency command source other than frequency command 1 (i.e., frequency command 2, frequency command via communication, or multi-frequency command), then the \wedge and \vee keys are disabled to change the current frequency command even in Running mode. Pressing either of these keys just displays the current reference frequency.
- When you start specifying the reference frequency or any other parameter with the \wedge / \vee key, the least significant digit on the display blinks; that is, the cursor lies in the least significant digit. Holding down the \wedge / \vee key changes data in the least significant digit and generates a carry, while the cursor remains in the least significant digit.
- After the least significant digit blinks by pressing the \wedge / \vee key, holding down the  key for more than 1 second moves the cursor from the least significant digit to the most significant digit. Further holding it down moves the cursor to the next lower digit. This cursor movement allows you to easily move the cursor to the desired digit and change the data in higher digits.
- By setting function code C30 to "0: \wedge / \vee keys on keypad" and selecting frequency command 2, you can also specify or change the frequency command in the same manner using the \wedge / \vee key.

You can set a reference frequency not only with the frequency (Hz) but also with other menu items (motor speed, load shaft speed, line speed and constant feeding rate time) depending on the setting of function code E48 (= 3, 4, 5 or 6) as listed in Table 3.1.

■ Settings under PID process control

To enable the PID process control, you need to set function code J01 to "1" or "2."

Under the PID control, the items that can be specified or checked with \wedge and \vee keys are different from those under regular frequency control, depending upon the current LED monitor setting. If the LED monitor is set to the speed monitor (E43 = 0), you can access manual speed commands (frequency command) with \wedge and \vee keys; if it is set to any other, you can access the PID process command with those keys.

 Refer to Chapter 4, Section 4.5, "PID Process Control Block."

Setting the PID process command with \wedge and \vee keys

- (1) Set function code J02 to "0": \wedge / \vee keys on keypad."
- (2) Set the LED monitor to something other than the speed monitor (E43=0) when the inverter is in Running mode. When the keypad is in Programming or Alarm mode, you cannot modify the PID process command with the \wedge / \vee key. To enable the PID process command to be modified with the \wedge / \vee key, first switch to Running mode.
- (3) Press the \wedge / \vee key to display the PID process command. The lowest digit and its decimal point blinks on the LED monitor.
- (4) To change the PID process command, press the \wedge / \vee key again. The PID process command you have specified will be automatically saved into the inverter's internal memory. It is retained even if you temporarily switch to another PID process command source and then go back to the via-keypad PID process command. Also, it is retained in the memory even while the inverter is powered off, and will be used as the initial PID process command next time the inverter is powered on.

-  Tip
- Even if multi-frequency is selected as a PID process command (**SS4** or **SS8** = ON), you still can set the process command using the keypad.
 - When function code J02 is set to any value other than "0," pressing the \wedge / \vee key displays, on the 7-segment LED monitor, the PID process command currently selected, while you cannot change the setting.
 - On the 7-segment LED monitor, the decimal point of the lowest digit is used to characterize what is displayed. The decimal point of the lowest digit blinks when a PID process command is displayed; the decimal point lights when a PID feedback amount is displayed.

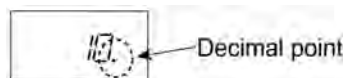

Table 3.2 PID Process Command Manually Set with \wedge / \vee Key and Requirements

PID control (Mode selection) J01	PID control (Remote command SV) J02	LED Monitor E43	Multi-frequency SS4 , SS8	With \wedge / \vee key
1 or 2	0	Other than 0	ON or OFF	PID process command <u>by keypad</u>
	Other than 0			PID process command <u>currently selected</u>

Setting up the frequency command with \wedge and \vee keys under PID process control

When function code F01 is set to "0" (\wedge / \vee keys on keypad) and frequency command 1 is selected as a manual speed command (when disabling the frequency setting command via communications link or multi-frequency command), switching the LED monitor to the speed monitor in Running mode enables you to modify the frequency command with the \wedge / \vee keys.

In Programming or Alarm mode, the \wedge / \vee keys are disabled to modify the frequency command. You need to switch to Running mode.

Table 3.3 lists the combinations of the commands and the figure illustrates how the manual speed command ① entered via the keypad is translated to the final frequency command ②.

The setting procedure is the same as that for setting of a usual frequency command.

Table 3.3 Manual Speed (Frequency) Command Specified with \wedge / \vee Keys and Requirements

PID control (Mode selection) J01	LED monitor E43	Frequency command 1 F01	Multi-frequency SS2	Multi-frequency SS1	Communications link operation LE	Cancel PID control Hz/PID	Pressing \wedge / \vee keys controls:	
1 or 2	0	0	OFF	OFF	OFF	OFF (PID enabled)	PID output (as final frequency command)	
						ON (PID disabled)	Manual speed (frequency) command set by keypad	
		Other than the above					OFF (PID enabled)	PID output (as final frequency command)
							ON (PID disabled)	Manual speed (frequency) command currently selected

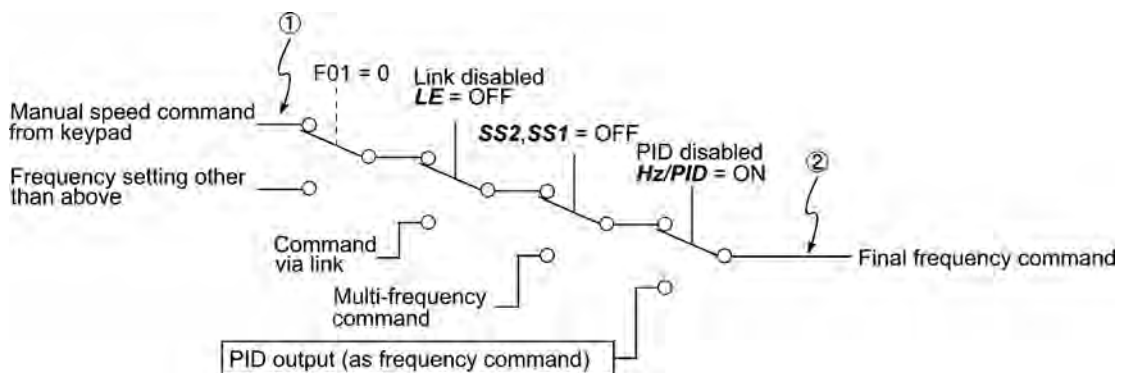

■ Settings under PID dancer control

To enable the PID dancer control, you need to set function code J01 to "3."

Under the PID control, the items that can be specified or checked with \wedge and \vee keys are different from those under the regular frequency control, depending upon the current LED monitor setting. If the LED monitor is set to the speed monitor (E43 = 0), the item accessible is the primary frequency command; if it is set to any other data, it is the PID dancer position command.

 Refer to Chapter 4, Section 4.6, "PID Dancer Control Block."

Setting the PID dancer position command with the \wedge and \vee keys

- (1) Set function code J02 to "0": \wedge / \vee keys on keypad."
- (2) Set the LED monitor to something other than the speed monitor (E43=0) when the inverter is in Running mode. When the keypad is in Programming or Alarm mode, you cannot modify the PID command with the \wedge / \vee key. To enable the PID dancer position command to be modified with the \wedge / \vee key, first switch to Running mode.
- (3) Press the \wedge / \vee key to display the PID dancer position command. The lowest digit blinks on the LED monitor.
- (4) To change the command, press the \wedge / \vee key again. The command you have specified will be automatically saved into the inverter's internal memory as function code J57 data. It is retained even if you temporarily switch to another PID command source and then go back to the via-keypad PID command. Furthermore, you can directly configure the command with function code J57.



- Even if multi-frequency is selected as a PID command (**SS4** or **SS8** = ON), you still can set the PID dancer position command using the keypad.
- When function code J02 is set to any value other than "0," pressing the \wedge / \vee key displays, on the 7-segment LED monitor, the PID command currently selected, while you cannot change the setting.
- On the 7-segment LED monitor, the decimal point of the lowest digit is used to characterize what is displayed. The decimal point of the lowest digit blinks when a PID command is displayed; the decimal point lights when a PID feedback amount is displayed.

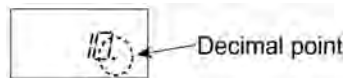

Table 3.4 PID Command Manually Set with \wedge / \vee Key and Requirements

PID control (Mode selection) J01	PID control (Remote command SV) J02	LED monitor E43	Multi-frequency SS4 , SS8	With \wedge / \vee key
3	0	Other than 0	ON or OFF	PID command <u>by keypad</u>
	Other than 0			PID command <u>currently selected</u>

Setting up the primary frequency command with \wedge and \vee keys under PID dancer control

When function code F01 is set to "0" (\wedge / \vee keys on keypad) and frequency command 1 is selected as a primary frequency command (when disabling the frequency setting command via communications link and multi-frequency command), switching the LED monitor in Running mode enables you to modify the frequency command with the \wedge / \vee keys.

In Programming or Alarm mode, the \wedge / \vee keys are disabled to modify the frequency command. You need to switch to Running mode.

Table 3.5 lists the combinations of the commands and the figure illustrates how the primary frequency command ① entered via the keypad is translated to the final frequency command ②.



The setting procedure is the same as that for setting of a usual frequency command.

Table 3.5 Primary Frequency Command Specified with \wedge / \vee Keys and Requirements

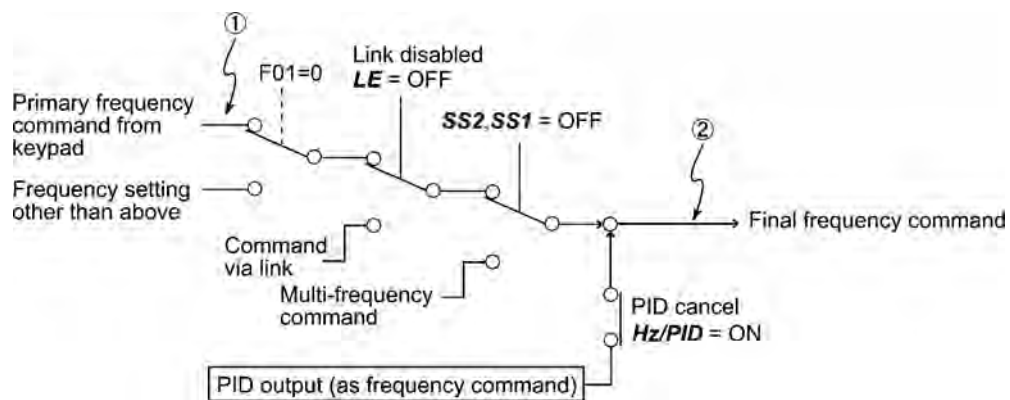
PID control (Mode selection) J01	LED monitor E43	Frequency command 1 F01	Multi-frequency <i>SS2</i>	Multi-frequency <i>SS1</i>	Communications link operation <i>LE</i>	Cancel PID control <i>Hz/PID</i>	Pressing \wedge / \vee keys controls:	
3	0	0	OFF	OFF	OFF	OFF (PID enabled)	Final frequency command modified by PID output	
						ON (PID disabled)	Keypad primary command (Frequency)	
		Other than the above					OFF (PID enabled)	Final frequency command modified by PID output
							ON (PID disabled)	Current primary command (Frequency)



3.2.3 Running/stopping the motor

By factory default, pressing the  key starts running the motor in the forward direction and pressing the  key decelerates the motor to stop. The  key is enabled only in Running mode.

The motor rotational direction can be selected by changing the setting of function code F02.

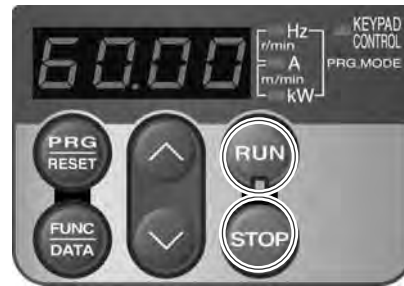

■ Operational relationship between function code F02 (Operation method) and key



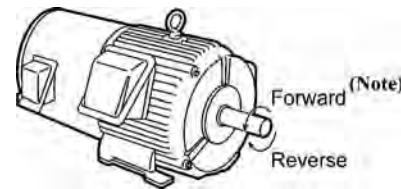

Table 3.6 lists the relationship between function code F02 settings and the  key, which determines the motor rotational direction.

Table 3.6 Motor Rotational Direction Specified by F02

Data for F02	Pressing the  key runs the motor:
0	In the direction commanded by terminal [FWD] or [REV]
1	 key disabled (The motor is driven by terminal [FWD] or [REV] command.)
2	In the forward direction
3	In the reverse direction





(Note) The rotational direction of IEC-compliant motors is opposite to that of the motor shown here.



 For the details on operations with function code F02, refer to Chapter 9 "FUNCTION CODES."

3.2.4 Jogging Operation

This section provides the procedure for jogging the motor.

- (1) Making the inverter ready to jog with the steps below. The LED monitor should display \overline{UOL} . Enter Running mode (see page 3-2) and press the  +  keys simultaneously.

The LED monitor displays the jogging frequency for approximately one second and then returns to \overline{UOL} again.

-  • Function codes C20 and H54 specify the jogging frequency and acceleration/deceleration time, respectively. Use these function codes exclusively for the jogging operation with your needs.
- Using the input terminal command "Ready for jogging" **JOG** switches between the normal operation state and ready-to-jog state.
- Switching between the normal operation state and read-to-jog state with the  +  keys is possible only when the inverter is stopped.

- (2) Jogging the motor.

Hold down the  key during which the motor continues jogging. To decelerate to stop the motor, release the key.

- (3) Exiting the ready-to-jog state and returning to the normal operation state.

- Press the  +  keys simultaneously.

 For details, refer to the descriptions of function codes E01 to E05 in Chapter 9, Section 9.2.2 "E codes (Terminal functions)."

3.3 Programming Mode

The Programming mode provides you with these functions--setting and checking function code data, monitoring maintenance information and checking input/output (I/O) signal status. The functions can be easily selected with the menu-driven system. Table 3.7 lists menus available in Programming mode. The leftmost digit (numerals) of each letter string on the LED monitor indicates the corresponding menu number and the remaining three digits indicate the menu contents.

When the inverter enters Programming mode from the second time on, the menu selected last in Programming mode will be displayed.

Table 3.7 Menus Available in Programming Mode

Menu #	Menu	LED monitor shows:	Main functions	Refer to:	
0	"Quick Setup"	<i>Q.FnC</i>	Displays only basic function codes to customize the inverter operation.	Section 3.3.1	
1	"Data Setting"	<i>F--</i>	F codes (Fundamental functions)	Selecting each of these function codes enables its data to be displayed/changed.	Section 3.3.2
		<i>E--</i>	E codes (Extension terminal functions)		
		<i>C--</i>	C codes (Control functions)		
		<i>P--</i>	P codes (Motor 1 parameters)		
		<i>H--</i>	H codes (High performance functions)		
		<i>A--</i>	A codes (Motor 2 parameters)		
		<i>U--</i>	J codes (Application functions)		
		<i>Y--</i>	y codes (Link functions)		
		<i>O--</i>	o codes (Optional function)		
2	"Data Checking"	<i>2.rEP</i>	Displays only function codes that have been changed from their factory defaults. You can refer to or change those function code data.	Section 3.3.3	
3	"Drive Monitoring"	<i>3.oPE</i>	Displays the running information required for maintenance or test running.	Section 3.3.4	
4	"I/O Checking"	<i>4.I.O</i>	Displays external interface information.	Section 3.3.5	
5	"Maintenance Information"	<i>5.CHE</i>	Displays maintenance information including cumulative run time.	Section 3.3.6	
6	"Alarm Information"	<i>6.AL</i>	Displays the latest four alarm codes. You can refer to the running information at the time when the alarm occurred.	Section 3.3.7	

(Note 1) Mounting a multi-function keypad adds the data copying function to the menu, enabling reading, writing, and verifying of function code data.

(Note 2) The o codes are displayed only when the corresponding option is mounted. For details, refer to the Instruction Manual for the corresponding option.

Figure 3.3 illustrates the menu-driven function code system in Programming mode.

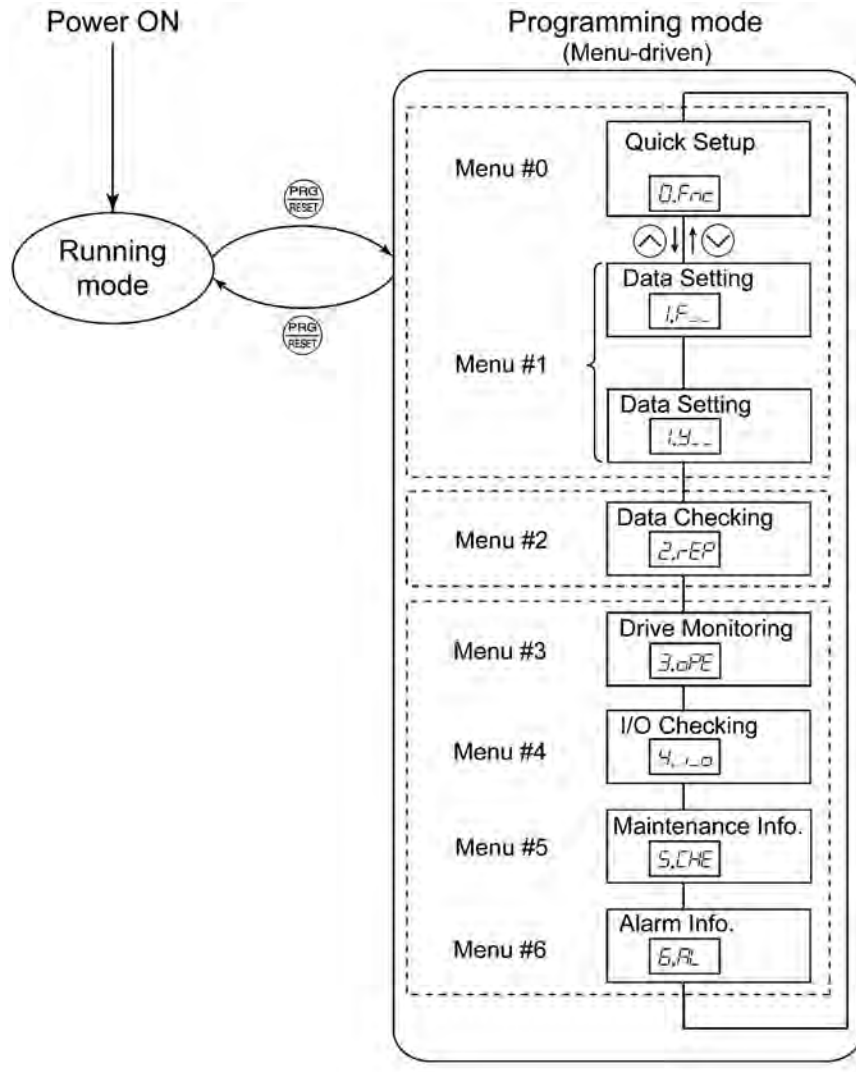

Figure 3.3 Menu Transition in Programming Mode

■ **Selecting menus to display**



The menu-driven system allows you to cycle through menus. To cycle through necessary menus only for simple operation, use function code E52 that provides a choice of three display modes as listed below.

The factory default (E52 = 0) is to display only two menus--Menu #0 "Quick Setup" and Menu #1 "Data Setting," allowing no switching to any other menu.

Table 3.8 Keypad Display Mode Selection – Function Code E52

Data for E52	Mode	Menus selectable
0	Function code data editing mode (factory default)	Menu #0 "Quick Setup" Menu #1 "Data Setting"
1	Function code data check mode	Menu #2 "Data Checking"
2	Full-menu mode	Menus #0 through #6



Pressing the  key will cycle through the menu. With the  key, you can select the desired menu item. Once the entire menu has been cycled through, the display will return to the first menu item.

3.3.1 Setting up basic function codes quickly **-- Menu #0 "Quick Setup" --**

Menu #0 "Quick Setup" in Programming mode allows you to quickly display and set up a basic set of function codes specified in Chapter 9, Section 9.1, "Function Code Tables."

To use Menu #0 "Quick Setup," you need to set function code E52 to "0" (Function code data editing mode) or "2" (Full-menu mode).

The predefined set of function codes that are subject to quick setup are held in the inverter.

Listed below are the function codes (including those not subject to quick setup) available on the FRENIC-Multi. A function code is displayed on the LED monitor on the keypad in the following format:

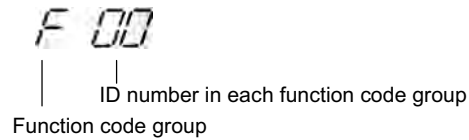

Table 3.9 Function Codes Available on FRENIC-Multi

Function Code Group	Function Codes	Function	Description
F codes	F00 to F51	Fundamental functions	Functions concerning basic motor running
E codes	E01 to E99	Extension terminal functions	Functions concerning the assignment of control circuit terminals Functions concerning the display of the LED monitor
C codes	C01 to C53	Control functions	Functions associated with frequency settings
P codes	P01 to P99	Motor 1 parameters	Functions for setting up characteristics parameters (such as capacity) of the motor
H codes	H03 to H98	High performance functions	Highly added-value functions Functions for sophisticated control
A codes	A01 to A46	Motor 2 parameters	Functions for setting up characteristics parameters (such as capacity) of the motor
J codes	J01 to J86	Application functions	Functions for applications such as PID control
y codes	y01 to y99	Link functions	Functions for controlling communication
o codes	o27 to o59	Optional functions	Functions for options (Note)

(Note) The o codes are displayed only when the corresponding option is mounted. For details of the o codes, refer to the Instruction Manual for the corresponding option.



For the list of function codes subject to quick setup and their descriptions, refer to Chapter 9, Section 9.1 "Function Code Tables."

■ **Function codes requiring simultaneous keying**

To modify the data for function code F00 (Data Protection), H03 (Data Initialization), H45 (Mock Alarm), or H97 (Clear Alarm Data), simultaneous keying is needed, involving the + keys or + keys.

■ **Changing, validating, and saving function code data when the inverter is running**

Some function code data can be changed while the inverter is running, whereas others cannot. Further, depending on the function code, modifications may or may not validate immediately. For details, refer to the "Change when running" column in Chapter 9, Section 9.1 "Function Code Tables."



For details of function codes, refer to Chapter 9, Section 9.1 "Function Code Tables."

Figure 3.4 shows the menu transition in Menu #0 "Quick Setup."

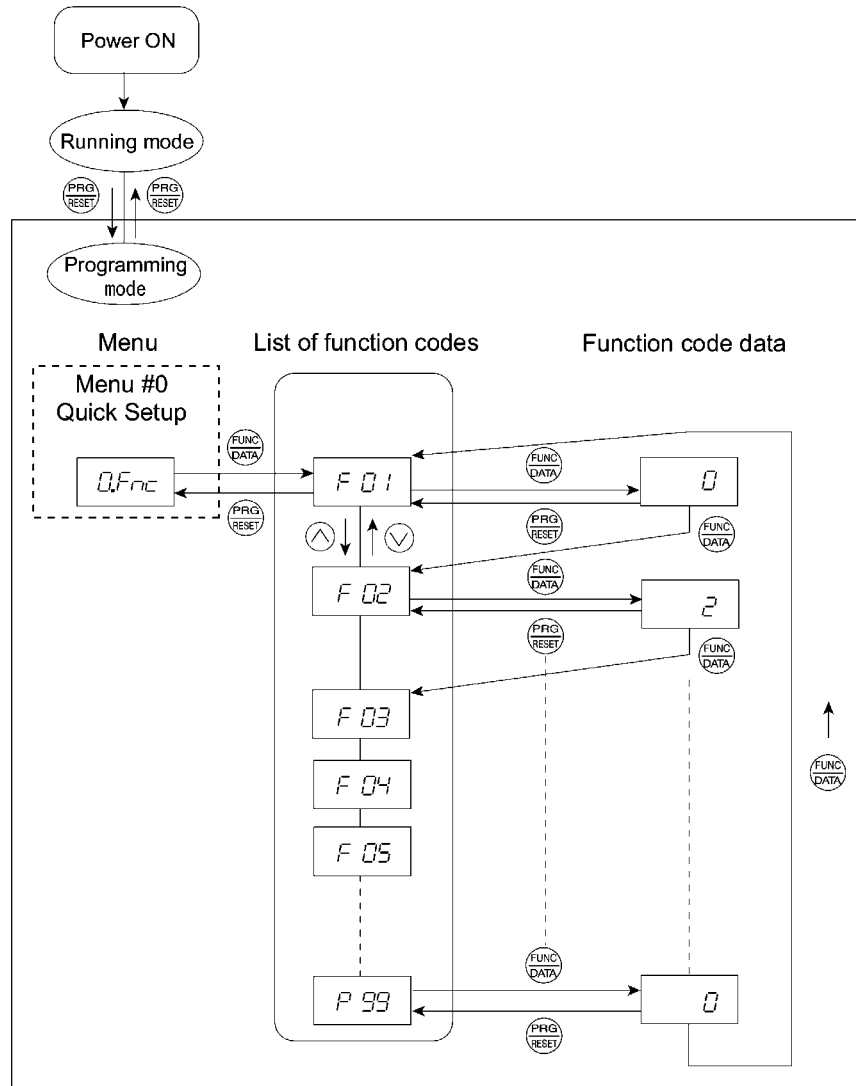

Figure 3.4 Menu Transition in Menu #0 "Quick Setup"

















Through a multi-function keypad, you can add or delete function codes that are subject to Quick Setup. For details, refer to the "Multi-function Keypad Instruction Manual."

Once you have added or deleted function codes for Quick Setup through a multi-function keypad, they will remain valid even after you switch to a standard keypad. To restore the function code settings subject to Quick Setup to their factory defaults, initialize the whole data using function code H03 (data = 1).

Basic key operation

This section gives a description of the basic key operation, following the example of the function code data changing procedure shown in Figure 3.5.

This example shows you how to change function code F01 data from the factory default "Ⓐ/Ⓢ keys on keypad (F01 = 0)" to "Current input to terminal [C1] (C1 function) (4 to 20 mA DC) (F01 = 2)."

- (1) Turn the inverter on. It automatically enters Running mode. In that mode, press the  key to switch to Programming mode. The function selection menu appears. (In this example, *0.Fnc* is displayed.)
- (2) If anything other than *0.Fnc* is displayed, use the  and  keys to display *0.Fnc*.
- (3) Press the  key to proceed to a list of function codes.
- (4) Use the  and  keys to display the desired function code (*F 01* in this example), then press the  key.
The data of this function code appears. (In this example, data *0* of *F 01* appears.)
- (5) Change the function code data using the  and  keys. (In this example, press the  key two times to change data *0* to *2*.)
- (6) Press the  key to establish the function code data.
The *SAVE* appears and the data will be saved in the memory inside the inverter. The display will return to the function code list, then move to the next function code. (In this example, *F 02*.)
Pressing the  key instead of the  key cancels the change made to the data. The data reverts to the previous value, the display returns to the function code list, and the original function code reappears.
- (7) Press the  key to return to the menu from the function code list.



Tip Cursor movement

You can move the cursor when changing function code data by holding down the  key for 1 second or longer in the same way as with the frequency settings. This action is called "Cursor movement."

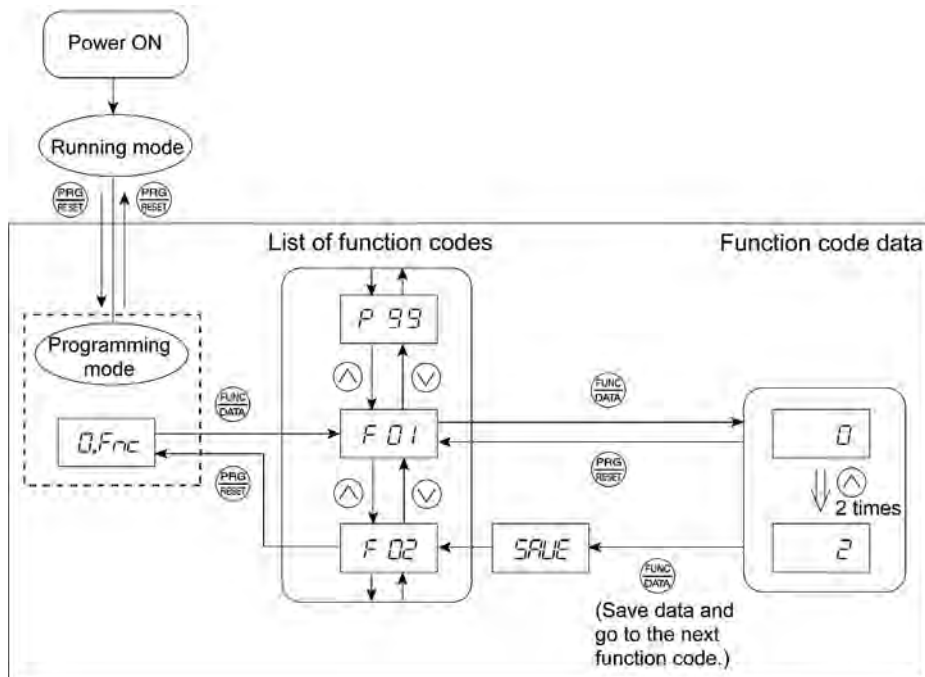

Figure 3.5 Example of Function Code Data Changing Procedure

3.3.2 Setting up function codes -- Menu #1 "Data Setting" --

Menu #1 "Data Setting" in Programming mode allows you to set up function codes for making the inverter functions match your needs.

To set function codes in this menu, it is necessary to set function code E52 to "0" (Function code data editing mode) or "2" (Full-menu mode).

Basic key operation

For details of the basic key operation, refer to Menu #0 "Quick Setup" in Section 3.3.1.

3.3.3 Checking changed function codes -- Menu #2 "Data Checking" --

Menu #2 "Data Checking" in Programming mode allows you to check function codes that have been changed. Only the function codes whose data has been changed from the factory defaults are displayed on the LED monitor. You can refer to the function code data and change it again if necessary. Figure 3.6 shows the menu transition in Menu #2 "Data Checking."

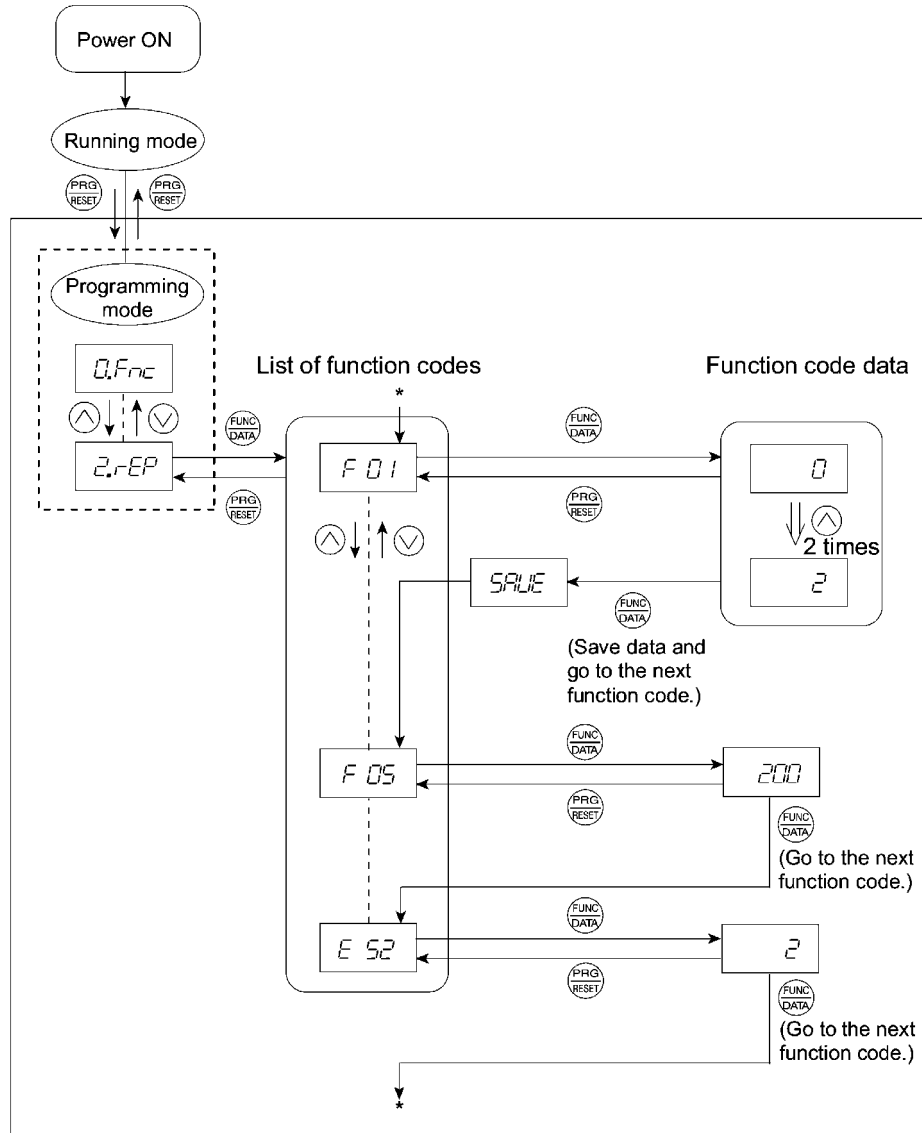

Figure 3.6 Menu Transition in Menu #2 "Data Checking" (Changing F01, F05 and E52 data only)

Basic key operation

For details of the basic key operation, refer to Menu #0 "Quick Setup" in Section 3.3.1.

Tip To check function codes in Menu #2 "Data Checking," it is necessary to set function code E52 to "1" (Function code data check mode) or "2" (Full-menu mode).

For details, refer to "■ Selecting menus to display" on page 3-12.

3.3.4 Monitoring the running status -- Menu #3 "Drive Monitoring" --

Menu #3 "Drive Monitoring" is used to monitor the running status during maintenance and trial running. The display items for "Drive Monitoring" are listed in Table 3.10. Figure 3.7 shows the menu transition in Menu #3 "Drive Monitoring."

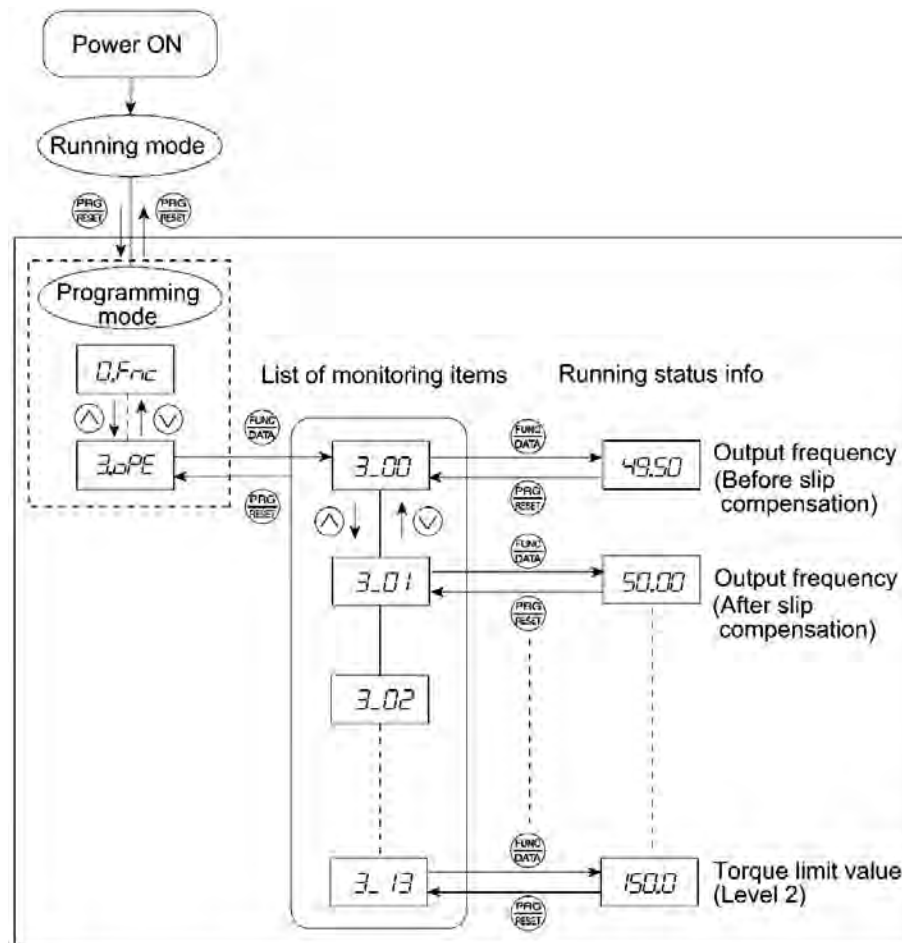

Figure 3.7 Menu Transition in Menu #3 "Drive Monitoring"

Basic key operation

To monitor the running status on the drive monitor, set function code E52 to "2" (Full-menu mode) beforehand.

- (1) Turn the inverter on. It automatically enters Running mode. In that mode, press the PRG/RESET key to switch to Programming mode. The function selection menu appears.
- (2) Use the ▲ and ▼ keys to display "Drive Monitoring" (3.0PE).
- (3) Press the FUNC/DATA key to proceed to a list of monitoring items (e.g. 3.00).
- (4) Use the ▲ and ▼ keys to display the desired monitoring item, then press the FUNC/DATA key. The running status information for the selected item appears.
- (5) Press the PRG/RESET key to return to a list of monitoring items. Press the PRG/RESET key again to return to the menu.

Table 3.10 Drive Monitor Display Items

LED monitor shows:	Item	Unit	Description
3.00	Output frequency	Hz	Output frequency before slip compensation
3.01	Output frequency	Hz	Output frequency after slip compensation
3.02	Output current	A	Output current
3.03	Output voltage	V	Output voltage
3.04	Calculated torque	%	Calculated output torque of the motor in %
3.05	Reference frequency	Hz	Frequency specified by a frequency command
3.06	Rotational direction	N/A	Rotational direction being outputted F: forward, r: reverse, ----: stop
3.07	Running status	N/A	Running status in hexadecimal format Refer to " ■ Displaying running status " on the next page.
3.08	Motor speed	r/min	Display value = (Output frequency Hz) × $\frac{120}{\text{(Function code P01)}}$ For motor 2, read P01 as A15.
3.09	Load shaft speed or Line speed	r/min m/min	Display value = (Output frequency Hz) × (Function code E50) The 7-segment letters E J appear for 10000 (r/min) or more. If E J appear, decrease function code E50 data so that the LED monitor displays 9999 or below, referring to the above equation.
3.10	PID command	N/A	Virtual physical value (e.g., temperature or pressure) of the object to be controlled, which is converted from the PID command using function code E40 and E41 data (PID display coefficients A and B) Display value = (PID command) × (Coefficient A - B) + B If PID control is disabled, "----" appears.
3.11	PID feedback amount	N/A	Virtual physical value (e.g., temperature or pressure) of the object to be controlled, which is converted from the PID command using function code E40 and E41 data (PID display coefficients A and B) Display value = (PID feedback amount) × (Coefficient A - B) + B If PID control is disabled, "----" appears.
3.12	Torque limit value (Level 1)	%	Driving torque limit value (based on motor rated torque)
3.13	Torque limit value (Level 2)	%	Braking torque limit value (based on motor rated torque)

■ Displaying running status

To display the running status in hexadecimal format, each state has been assigned to bits 0 to 15 as listed in Table 3.11. Table 3.12 shows the relationship between each of the status assignments and the LED monitor display. Table 3.13 gives the conversion table from 4-bit binary to hexadecimal.

Table 3.11 Running Status Bit Assignment

Bit	Notation	Content	Bit	Notation	Content
15	BUSY	"1" when function code data is being written.	7	VL	"1" under voltage limiting control.
14	WR	Always "0."	6	TL	"1" under torque limiting control.
13		Always "0."	5	NUV	"1" when the DC link bus voltage is higher than the undervoltage level.
12	RL	"1" when communication is enabled (when ready for run and frequency commands via communications link).	4	BRK	"1" during braking.
11	ALM	"1" when an alarm has occurred.	3	INT	"1" when the inverter output is shut down.
10	DEC	"1" during deceleration.	2	EXT	"1" during DC braking.
9	ACC	"1" during acceleration.	1	REV	"1" during running in the reverse direction.
8	IL	"1" under current limiting control.	0	FWD	"1" during running in the forward direction.

Table 3.12 Running Status Display

LED No.	LED4				LED3				LED2				LED1			
Bit	15	14	13	12	11	10	9	8	7	6	5	4	3	2	1	0
Notation	BUSY	WR	RL	ALM	DEC	ACC	IL	VL	TL	NUV	BRK	INT	EXT	REV	FWD	
Example	Binary	1	0	0	0	0	0	1	1	0	0	1	0	0	0	1
	Hexadecimal on the LED monitor															

■ Hexadecimal expression

A 4-bit binary number can be expressed in hexadecimal format (1 hexadecimal digit). Table 3.13 shows the correspondence between the two notations. The hexadecimals are shown as they appear on the LED monitor.

Table 3.13 Binary and Hexadecimal Conversion

Binary				Hexadecimal	Binary				Hexadecimal
0	0	0	0	0	1	0	0	0	0
0	0	0	1	1	1	0	0	1	1
0	0	1	0	2	1	0	1	0	2
0	0	1	1	3	1	0	1	1	3
0	1	0	0	4	1	1	0	0	4
0	1	0	1	5	1	1	0	1	5
0	1	1	0	6	1	1	1	0	6
0	1	1	1	7	1	1	1	1	7

3.3.5 Checking I/O signal status -- Menu #4 "I/O Checking" --

Using Menu #4 "I/O Checking" displays the I/O status of external signals including digital and analog I/O signals without using a measuring instrument. Table 3.14 lists check items available. The menu transition in Menu #4 "I/O Checking" is shown in Figure 3.8.

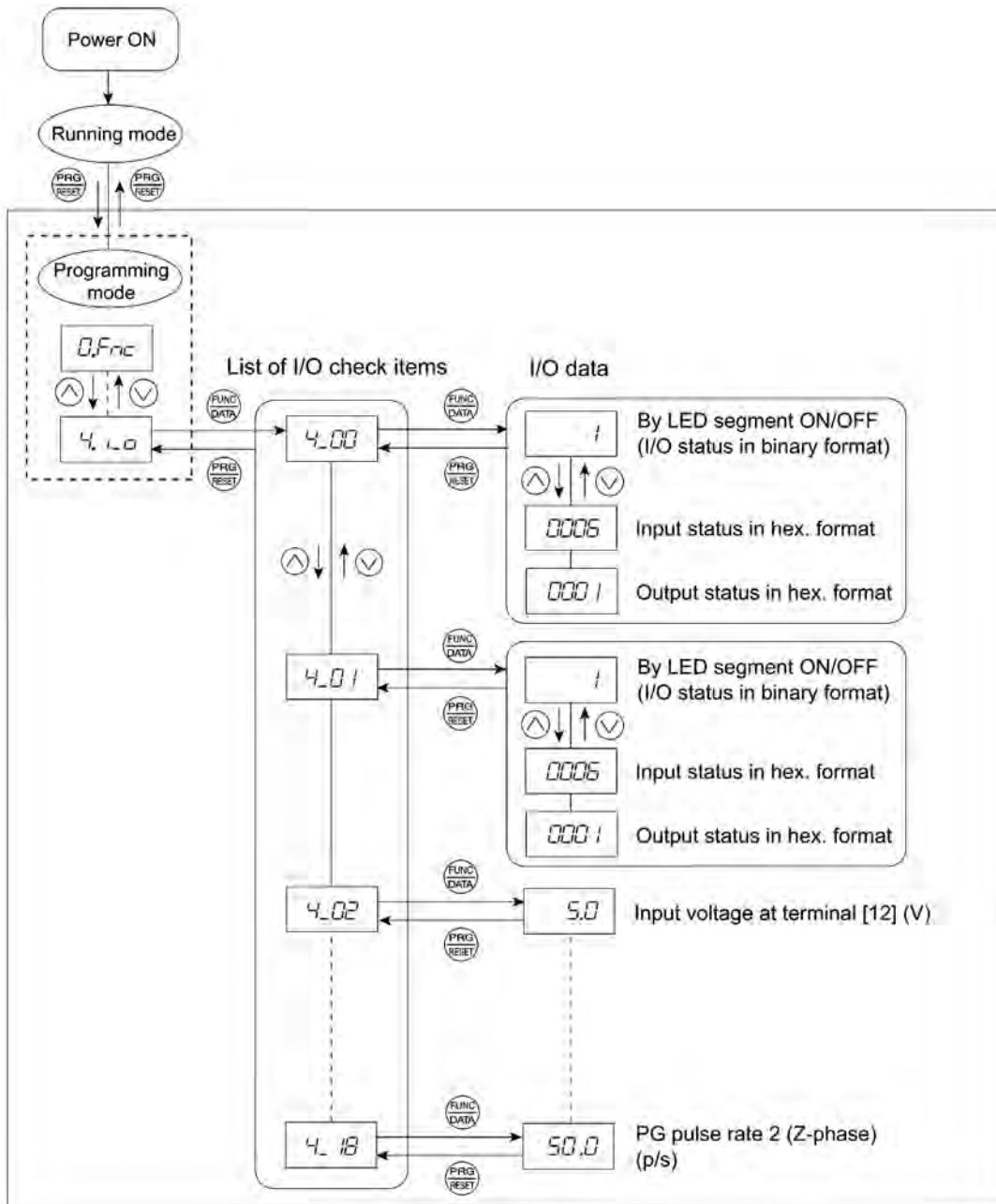

Figure 3.8 Menu Transition in Menu #4 "I/O Checking"

Basic key operation

To check the status of the I/O signals, set function code E52 to "2" (Full-menu mode) beforehand.











- (1) Turn the inverter on. It automatically enters Running mode. In that mode, press the  key to switch to Programming mode. The function selection menu appears.
- (2) Use the  and  keys to display "I/O Checking" (4_1_0).
- (3) Press the  key to proceed to a list of I/O check items (e.g. 4_00).
- (4) Use the  and  keys to display the desired I/O check item, then press the  key. The corresponding I/O check data appears. For the item 4_00 or 4_01, using the  and  keys switches the display method between the segment display (for external signal information in Table 3.15) and hexadecimal display (for I/O signal status in Table 3.16).
- (5) Press the  key to return to a list of I/O check items. Press the  key again to return to the menu.

Table 3.14 I/O Check Items

LED monitor shows:	Item	Description
4_00	I/O signals on the control circuit terminals	Shows the ON/OFF state of the digital I/O terminals. Refer to " ■ Displaying control I/O signal terminals " on the next page for details.
4_01	I/O signals on the control circuit terminals under communications control	Shows the ON/OFF state of the digital I/O terminals that received a command via RS-485 and optional communications. Refer to " ■ Displaying control I/O signal terminals " and " ■ Displaying control I/O signal terminals under communications control " on the following pages for details.
4_02	Input voltage on terminal [12]	Shows the input voltage on terminal [12] in volts (V).
4_03	Input current on terminal [C1]	Shows the input current on terminal [C1] in milliamperes (mA).
4_04	Output voltage to analog meters [FM]	Shows the output voltage on terminal [FM] in volts (V).
4_05	Pulse rate of [FM]	Shows the output pulse rate on terminal [FM] in pulses per second (p/s).
4_07	Input voltage on terminal [C1]	Shows the input voltage on terminal [C1] (V2 function assigned) in volts (V).
4_10	Option control circuit terminal (I/O)	Shows the ON/OFF state of the digital I/O terminals on the optional DI/O interface card. Refer to " ■ Displaying control I/O signal terminals on optional DI/O interface card " on page 3-25 for details.
4_15	PG pulse rate 1 (A/B phase)	Shows the A/B phase pulse rate (p/s) in quad frequency when the PG interface is installed. Displayed value = Pulse rate (p/s) ÷ 1000
4_16	PG pulse rate 1 (Z phase)	Shows the pulse rate (p/s) in Z phase when the PG interface is installed.
4_17	PG pulse rate 2 (A/B phase)	Shows the A/B phase pulse rate (p/s) of the second PG in quad frequency when two PG interfaces are installed. Displayed value = Pulse rate (p/s) ÷ 1000
4_18	PG pulse rate 2 (Z phase)	Shows the second PG pulse rate (p/s) in Z phase when two PG interfaces are installed.

■ Displaying control I/O signal terminals

The status of control I/O signal terminal may be displayed with ON/OFF of the LED segment or in hexadecimal display.

- Display I/O signal status with ON/OFF of each LED segment

As shown in Table 3.15 and the figure below, each of segments "a" to "g" on LED1 lights when the corresponding digital input terminal circuit ([FWD], [REV], [X1], [X2], [X3], [X4] or [X5]) is closed; it goes off when it is open. Segment "a" and "b" on LED3 light when the circuit between output terminal [Y1] or [Y2] and terminal [CMY], and do not light when the circuit is open. Segment "a" on LED4 is for terminals [30A/B/C]. Segment "a" on LED4 lights when the circuit between terminals [30C] and [30A] is short-circuited (ON) and does not light when it is open.

 **Tip** If all terminal input signals are OFF (open), segment "g" on all of LED1 to LED4 will blink ("-----").

Table 3.15 Segment Display for External Signal Information



Segment	LED4	LED3	LED2	LED1
a	30A/B/C	Y1-CMY	—	FWD
b	—	Y2-CMY	—	REV
c	—	—	—	X1
d	—	—	—	X2
e	—	—	—	X3
f	—	—	(XF)*	X4
g	—	—	(XR)*	X5
dp	—	—	(RST)*	—

—: No corresponding control circuit terminal exists

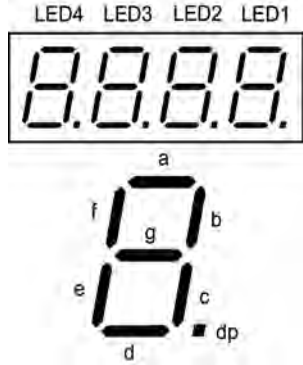
* (XF), (XR), and (RST) are assigned for communication. Refer to "**■ Displaying control I/O signal terminals under communications control**" on the next page.

- Displaying I/O signal status in hexadecimal format

Each I/O terminal is assigned to bit 15 through bit 0 as shown in Table 3.16. An unassigned bit is interpreted as "0." Allocated bit data is displayed on the LED monitor in 4 hexadecimal digits (LED4 to LED1 each).

With the FRENIC-Multi, digital input terminals [FWD] and [REV] are assigned to bit 0 and bit 1, respectively. Terminals [X1] through [X5] are assigned to bits 2 through 6. The bit is set to "1" when the corresponding input terminal is short-circuited (ON), and is set to "0" when it is open (OFF). For example, when [FWD] and [X1] are on (short-circuited) and all the others are off (open), 0005 is displayed on LED4 to LED1.

Digital output terminal [Y1] and [Y2] are assigned to bits 0 and 1. Each bit is set to "1" when the terminal is short-circuited with [CMY], and "0" when it is open.

The status of the relay contact output terminal [30A/B/C] is assigned to bit 8. It is set to "1" when the circuit between output terminals [30A] and [30C] is closed, and "0" when the circuit between [30A] and [30C] is open.

For example, if [Y1] is on, [Y2] is off, and the circuit between [30A] and [30C] is closed, then "0005" is displayed on the LED4 to LED1.

Table 3.16 presents an example of bit assignment and corresponding hexadecimal display on the 7-segment LED.

Table 3.16 Segment Display for I/O Signal Status in Hexadecimal Format

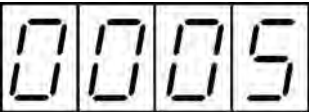
LED No.	LED4				LED3				LED2				LED1			
Bit	15	14	13	12	11	10	9	8	7	6	5	4	3	2	1	0
Input terminal	(RST)*	(XR)*	(XF)*	-	-	-	-	-	-	X5	X4	X3	X2	X1	REV	FWD
Output terminal	-	-	-	-	-	-	-	30 A/B/C	-	-	-	-	-	-	Y2	Y1
Example	Binary	0	0	0	0	0	0	0	0	0	0	0	0	1	0	1
	Hexadecimal on the LED monitor	 LED4 LED3 LED2 LED1														

- No corresponding control circuit terminal exists.

* (XF), (XR), and (RST) are assigned for communication. Refer to "**■ Displaying control I/O signal terminals under communications control**" below.

■ Displaying control I/O signal terminals under communications control

Under communications control, input commands (function code S06) sent via RS-485 or other optional communications can be displayed in two ways: "with ON/OFF of each LED segment" and "in hexadecimal format." The content to be displayed is basically the same as that for the control I/O signal terminal status display; however, (XF), (XR), and (RST) are added as inputs. Note that under communications control, the I/O display is in normal logic (using the original signals not inverted).

 Refer to the RS-485 Communication User's Manual for details on input commands sent through RS-485 communications and the instruction manual of communication-related options as well.

■ Displaying control I/O signal terminals on optional DI/O interface card

The LED monitor can also show the signal status of the terminals on the optional DI/O interface card, just like the control circuit terminals.

Table 3.17 lists the assignment between LED segments and DI/O signals.

Table 3.17 Segment Display for External Signal Information



Segment	LED4	LED3	LED2	LED1
a	—	DO0	DI8	DI0
b	—	DO1	DI9	DI1
c	—	DO2	DI10	DI2
d	—	DO3	DI11	DI3
e	—	DO4	DI12	DI4
f	—	DO5	—	DI5
g	—	DO6	—	DI6
dp	—	DO7	—	DI7

LED No.	LED4				LED3				LED2				LED1			
	15	14	13	12	11	10	9	8	7	6	5	4	3	2	1	0
Input terminal	-	-	-	DI12	DI11	DI10	DI9	DI8	DI7	DI6	DI5	DI4	DI3	DI2	DI1	DI0
Output terminal	-	-	-	-	-	-	-	-	DO7	DO6	DO5	DO4	DO3	DO2	DO1	DO0

3.3.6 Reading maintenance information

-- Menu #5 "Maintenance Information" --

Menu #5 "Maintenance Information" contains information necessary for performing maintenance on the inverter. Table 3.18 lists the maintenance information display items and Figure 3.9 shows the menu transition in Menu #5 "Maintenance information."

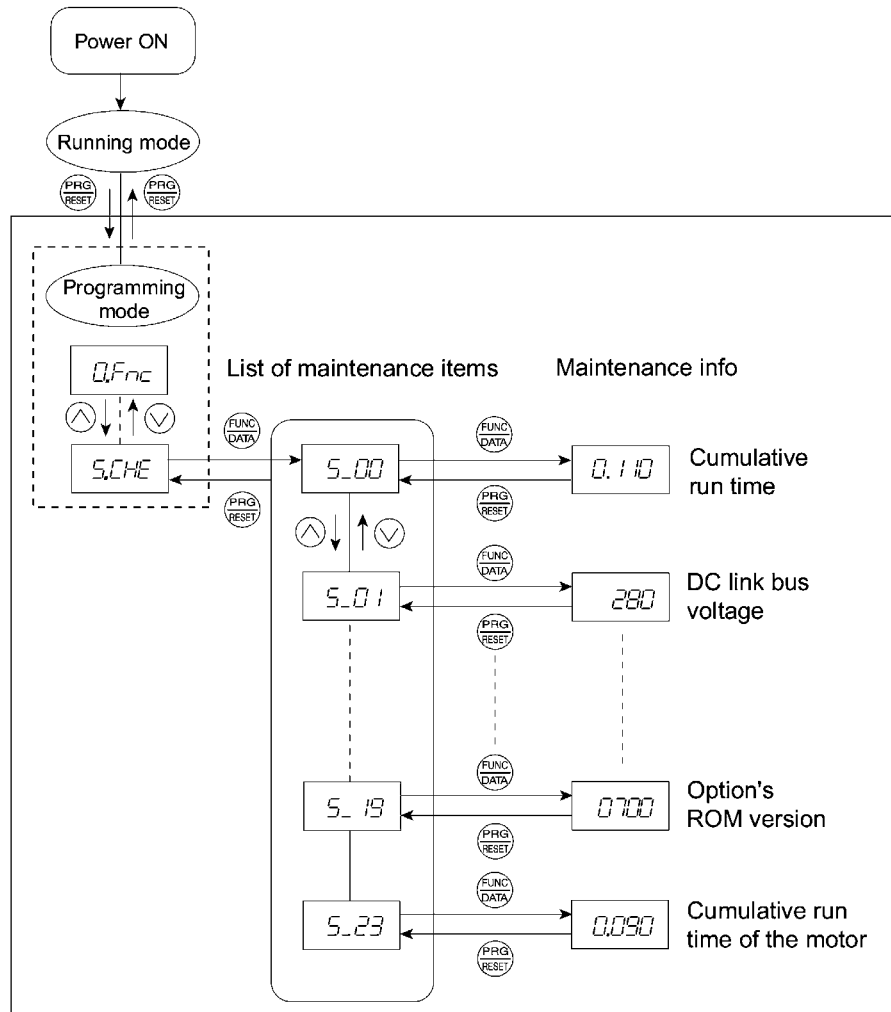

Figure 3.9 Menu Transition in Menu #5 "Maintenance Information"

Basic key operation

To view the maintenance information, set function code E52 to "2" (Full-menu mode) beforehand.

- (1) Turn the inverter on. It automatically enters Running mode. In that mode, press the key to switch to Programming mode. The function selection menu appears.
- (2) Use the and keys to display "Maintenance Information" (*S.CHE*).
- (3) Press the key to proceed to a list of maintenance item codes (e.g. *5.00*).
- (4) Use the and keys to display the desired maintenance item, then press the key. The data of the corresponding maintenance item appears.
- (5) Press the key to return to a list of maintenance items. Press the key again to return to the menu.

Table 3.18 Display Items for Maintenance Information

LED Monitor shows:	Item	Description
5.00	Cumulative run time	Shows the content of the cumulative power-ON time counter of the inverter. Unit: thousands of hours. (Display range: 0.001 to 9.999, 10.00 to 65.53) When the total ON-time is less than 10000 hours (display: 0.001 to 9.999), data is shown in units of one hour (0.001). When the total time is 10000 hours or more (display: 10.00 to 65.53), it is shown in units of 10 hours (0.01). When the total time exceeds 65535 hours, the counter will be reset to 0 and the count will start again.
5.01	DC link bus voltage	Shows the DC link bus voltage of the inverter main circuit. Unit: V (volts)
5.03	Max. temperature of heat sink	Shows the maximum temperature of the heat sink for every hour. Unit: °C (Temperatures below 20°C (68°F) are displayed as 20°C.)
5.04	Max. effective output current	Shows the maximum current in RMS for every hour. Unit: A (amperes)
5.05	Capacitance of the DC link bus capacitor	Shows the current capacitance of the DC link bus capacitor (reservoir capacitor) in %, based on the capacitance when shipping as 100%. Refer to the FRENIC-Multi Instruction Manual, Chapter 7 "MAINTENANCE AND INSPECTION" for details. Unit: %
5.06	Cumulative run time of electrolytic capacitors on the printed circuit boards	Shows the content of the cumulative run time counter of the electrolytic capacitors mounted on the printed circuit boards. Unit: thousands of hours. (Display range: 0.001 to 99.99) Shown in units of 10 hours. When the total time exceeds 99990 hours, the count stops and the display remains at 99.99.
5.07	Cumulative run time of the cooling fan	Shows the content of the cumulative run time counter of the cooling fan. This counter does not work when the cooling fan ON/OFF control (function code H06) is enabled but the fan does not run. Unit: thousands of hours. (Display range: 0.001 to 99.99) Shown in units of 10 hours. When the total time exceeds 99990 hours, the count stops and the display remains at 99.99.
5.08	Number of startups	Shows the content of the cumulative counter of times the inverter is started up (i.e., the number of run commands issued). 1.000 indicates 1000 times. When any number from 0.001 to 9.999 is displayed, the counter increases by 0.001 per startup, and when any number from 10.00 to 65.53 is counted, the counter increases by 0.01 every 10 startups. When the counted number exceeds 65535, the counter will be reset to 0 and the count will start again.
5.09	Input watt-hour	Shows the input watt-hour of the inverter. Unit: 100 kWh (Display range: 0.001 to 9999) Depending on the value of integrated input watt-hour, the decimal point on the LED monitor shifts to show it within the LED monitor's resolution (e.g. the resolution varies between 0.001, 0.01, 0.1 or 1). To reset the integrated input watt-hour and its data, set function code E51 to "0.000." When the input watt-hour exceeds 1000000 kWh, it returns to "0."

Table 3.18 Display Items for Maintenance Information (continued)

LED Monitor shows:	Item	Description
5_10	Input watt-hour data	Shows the value expressed by "input watt-hour (kWh) × E51 (whose data range is 0.000 to 9999)." Unit: None. (Display range: 0.001 to 9999. The data cannot exceed 9999. (It will be fixed at 9999 once the calculated value exceeds 9999.)) Depending on the value of integrated input watt-hour data, the decimal point on the LED monitor shifts to show it within the LED monitors' resolution. To reset the integrated input watt-hour data, set function code E51 to "0.000."
5_11	Number of RS-485 errors (standard)	Shows the total number of errors that have occurred in <i>standard</i> RS-485 communication (via the RJ-45 connector as standard) since the power is turned on. Once the number of errors exceeds 9999, the count returns to 0.
5_12	Content of RS-485 communications error (standard)	Shows the most recent error that has occurred in <i>standard</i> RS-485 communication in decimal format. For error contents, refer to the RS-485 Communication User's Manual.
5_13	Number of option errors	Shows the total number of optional communications card errors since the power is turned on. Once the number of errors exceeds 9999, the count returns to 0.
5_14	Inverter's ROM version	Shows the inverter's ROM version as a 4-digit code.
5_15	Keypad's ROM version	Shows the keypad's ROM version as a 4-digit code.
5_17	Number of RS-485 errors (option)	Shows the total number of errors that have occurred in <i>optional</i> RS-485 communication since the power is turned on. Once the number of errors exceeds 9999, the count returns to 0.
5_18	Content of RS-485 communications error (option)	Shows the most recent error that has occurred in <i>optional</i> RS-485 communication in decimal format. For error contents, refer to the RS-485 Communication User's Manual.
5_19	Option's ROM version	Shows the option's ROM version as a 4-digit code.
5_23	Cumulative motor run time	Shows the content of the cumulative power-ON time counter of the motor. The display method is the same as for "Cumulative run time" (5_00) above.

3.3.7 Reading alarm information -- Menu #6 "Alarm Information" --

Menu #6 "Alarm Information" shows the causes of the past 4 alarms in alarm code. Further, it is also possible to display alarm information that indicates the status of the inverter when the alarm occurred. Figure 3.10 shows the menu transition in Menu #6 "Alarm Information" and Table 3.19 lists the details of the alarm information.

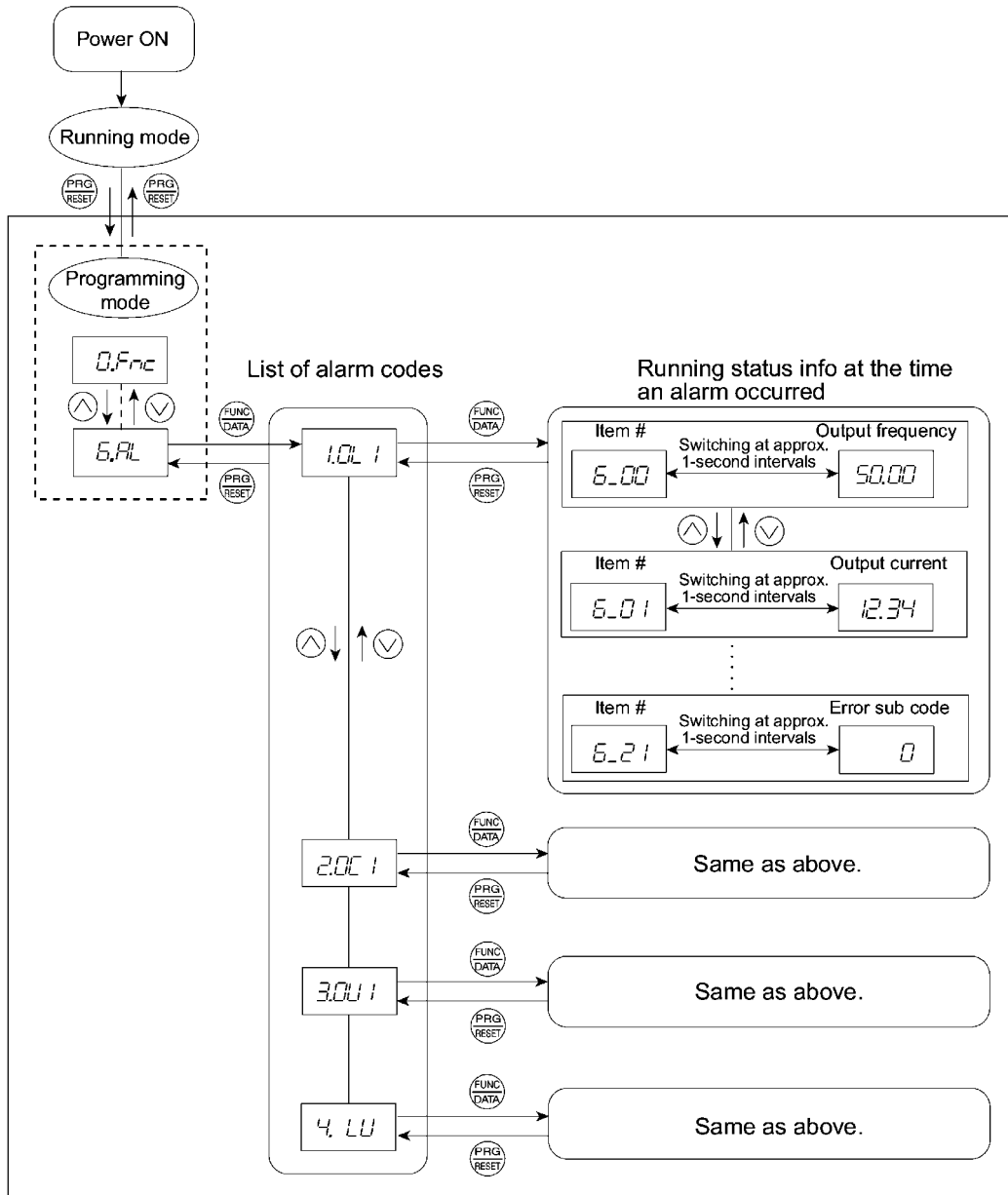

Figure 3.10 "Alarm Information" Menu Transition

Basic key operation

To view the alarm information, set function code E52 to "2" (Full-menu mode) beforehand.











- (1) Turn the inverter on. It automatically enters Running mode. In that mode, press the  key to switch to Programming mode. The function selection menu appears.
- (2) Use the  and  keys to display "Alarm Information" (E.FL).
- (3) Press the  key to proceed to a list of alarm codes (e.g. *1.1L 1*).
In the list of alarm codes, the alarm information for the last 4 alarms is saved as an alarm history.
- (4) Each time the  or  key is pressed, the last 4 alarms are displayed in order from the most recent one as *1, 2, 3* and *4*.
- (5) While the alarm code is displayed, press the  key to have the corresponding alarm item number (e.g. *E_00*) and data (e.g. Output frequency) displayed alternately in intervals of approximately 1 second. You can also have the item number (e.g. *E_0 1*) and data (e.g. Output current) for any other item displayed using the  and  keys.
- (6) Press the  key to return to a list of alarm codes. Press the  key again to return to the menu.

Table 3.19 Alarm Information Displayed

LED monitor shows: (item No.)	Item displayed	Description
<i>E_00</i>	Output frequency	Output frequency
<i>E_01</i>	Output current	Output current
<i>E_02</i>	Output voltage	Output voltage
<i>E_03</i>	Calculated torque	Calculated motor output torque
<i>E_04</i>	Reference frequency	Frequency specified by frequency command
<i>E_05</i>	Rotational direction	This shows the rotational direction being output. F: forward; r: reverse; - - - -: stop
<i>E_06</i>	Running status	This shows the running status in hexadecimal. Refer to " ■ Displaying running status " in Section 3.3.4.
<i>E_07</i>	Cumulative run time	Shows the content of the cumulative power-ON time counter of the inverter. Unit: thousands of hours. (Display range: 0.001 to 9.999, 10.00 to 65.53) When the total ON-time is less than 10000 hours (display: 0.001 to 9.999), data is shown in units of one hour (0.01). When the total time is 10000 hours or more (display: 10.00 to 65.53), it is shown in units of 10 hours (0.01). When the total time exceeds 65535 hours, the counter will be reset to 0 and the count will start again.
<i>E_08</i>	No. of startups	Shows the content of the cumulative counter of times the inverter is started up (i.e., the number of run commands issued). 1.000 indicates 1000 times. When any number from 0.001 to 9.999 is displayed, the counter increases by 0.001 per startup, and when any number from 10.00 to 65.53 is counted, the counter increases by 0.01 every 10 startups. When the counted number exceeds 65535, the counter will be reset to 0 and the count will start again.
<i>E_09</i>	DC link bus voltage	Shows the DC link bus voltage of the inverter main circuit. Unit: V (volts)

Table 3.19 Alarm Information Displayed (continued)

LED monitor shows: (item No.)	Item displayed	Description
E_11	Max. temperature of heat sink	Shows the temperature of the heat sink. Unit: °C
E_12	Terminal I/O signal status (displayed with the ON/OFF of LED segments)	Shows the ON/OFF status of the digital I/O terminals. Refer to " ■ Displaying control I/O signal terminals " in Section 3.3.5 "Checking I/O signal status" for details.
E_13	Terminal input signal status (in hexadecimal format)	
E_14	Terminal output signal status (in hexadecimal format)	
E_15	No. of consecutive occurrences	This is the number of times the same alarm occurs consecutively.
E_16	Multiple alarm 1	Simultaneously occurring alarm codes (1) ("----" is displayed if no alarms have occurred.)
E_17	Multiple alarm 2	Simultaneously occurring alarm codes (2) ("----" is displayed if no alarms have occurred.)
E_18	Terminal I/O signal status under communications control (displayed with the ON/OFF of LED segments)	Shows the ON/OFF status of the digital I/O terminals under RS-485 communications control. Refer to " ■ Displaying control I/O signal terminals under communications control " in Section 3.3.5 "Checking I/O signal status" for details.
E_19	Terminal input signal status under communications control (in hexadecimal format)	
E_20	Terminal output signal status under communications control (in hexadecimal format)	
E_21	Error sub code	Secondary error code for the alarm.





When the same alarm occurs repeatedly in succession, the alarm information for the first occurrences will be preserved and the information for other occurrences in-between will be discarded. The number of consecutive occurrences will be preserved as the first alarm information.

3.4 Alarm Mode

If an abnormal condition arises, the protective function is invoked and issues an alarm, then the inverter automatically enters Alarm mode. At the same time, an alarm code appears on the LED monitor.

3.4.1 Releasing the alarm and switching to Running mode



Remove the cause of the alarm and press the  key to release the alarm and return to Running mode. The alarm can be removed using the  key only when the alarm code is displayed.

3.4.2 Displaying the alarm history



It is possible to display the most recent 3 alarm codes in addition to the one currently displayed. Previous alarm codes can be displayed by pressing the  key while the current alarm code is displayed.

3.4.3 Displaying the status of inverter at the time of alarm

When the alarm code is displayed, you may check various running status information (output frequency and output current, etc.) by pressing the  key. The item number and data for each running information will be displayed alternately.

Further, you can view various pieces of information on the running status of the inverter using the  /  key. The information displayed is the same as for Menu #6 "Alarm Information" in Programming mode. Refer to Table 3.19 in Section 3.3.7, "Reading alarm information."

Pressing the  key while the running status information is displayed returns the display to the alarm codes.

 **Note** When the running status information is displayed after removal of the alarm cause, pressing the  key twice returns to the alarm code display and releases the inverter from the alarm state. This means that the motor starts running if a run command has been received by this time.

3.4.4 Switching to Programming mode



You can also switch to Programming mode by pressing  +  keys simultaneously with the alarm displayed, and modify the function code data.

Figure 3.11 summarizes the possible transitions between different menu items.

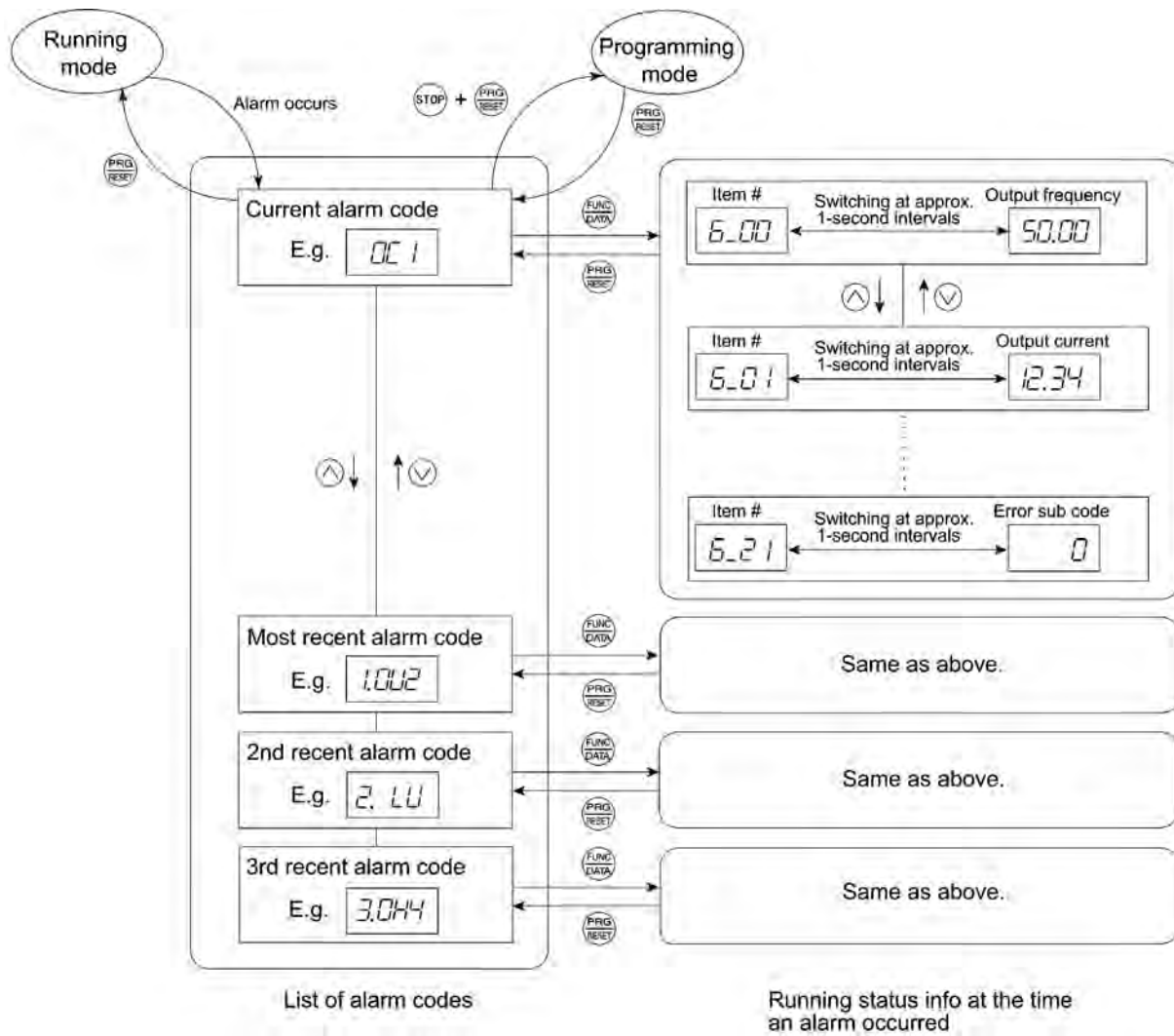

Figure 3.11 Menu Transition in Alarm Mode

Part 2 Driving the Motor



Chapter 4 BLOCK DIAGRAMS FOR CONTROL LOGIC

Chapter 5 RUNNING THROUGH RS-485 COMMUNICATION

Chapter 4

BLOCK DIAGRAMS FOR CONTROL LOGIC

This chapter describes the main block diagrams for the control logic of the FRENIC-Multi series of inverters.

Contents

4.1	Symbols Used in Block Diagrams and their Meanings.....	4-1
4.2	Drive Frequency Command Block.....	4-2
4.3	Drive Command Block	4-6
4.4	Control Block.....	4-8
4.5	PID Process Control Block	4-12
4.6	PID Dancer Control Block.....	4-16
4.7	FM Output Selector.....	4-19

FRENIC-Multi series of inverters is equipped with a number of function codes to match a variety of motor operations required in your system. Refer to Chapter 9 "FUNCTION CODES" for details of the function codes.

The function codes have functional relationship each other. Several special function codes also work with execution priority each other depending on their functions or data settings.







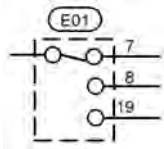

This chapter explains the main block diagrams for control logic in the inverter. You are requested to fully understand the inverter's control logic together with the function codes in order to set the function code data correctly.

The block diagrams contained in this chapter show only function codes having mutual relationship. For the function codes that work independently and for detailed explanation of each function code, refer to Chapter 9 "FUNCTION CODES."

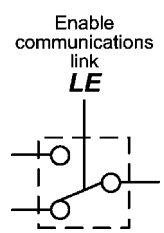
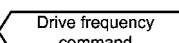
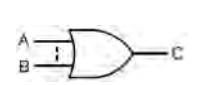
4.1 Symbols Used in Block Diagrams and their Meanings

Table 4.1 lists symbols commonly used in block diagrams and their meanings with some examples.

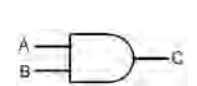
Table 4.1 Symbols and Meanings

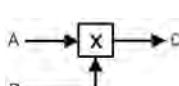
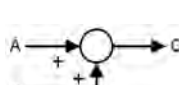
Symbol	Meaning	Symbol	Meaning
[FWD], [Y1] etc.	Digital inputs/outputs to/from the inverter's control circuit terminal block.		Function code.
<i>FWD</i> , <i>REV</i> etc.	Terminal commands assigned to digital inputs/outputs.		Switch controlled by a function code. Numbers assigned to the terminals express the function code data.
	Low-pass filter: Features appropriate characteristics by changing the time constant through the function code data.		Switch controlled by a terminal command. In the example shown on the left, the enable communications link command <i>LE</i> assigned to one of the digital input terminals from [X1] to [X5] controls the switch.
	Internal control signal for inverter logic.		OR logic: In normal logic, if any input is ON, then C = ON. Only if all inputs are OFF, then C = OFF.
	High limiter: Limits the upper value by a constant or data set to a function code.		NOR (Not-OR) logic: In normal logic, if any input is OFF, then C = ON. If all inputs are ON, C = OFF.
	Low limiter: Limits the lower value by a constant or data set to a function code.		AND logic: In normal logic, only if A = ON and B = ON, then C = ON. Otherwise, C = OFF.
	Zero limiter: Prevents data from dropping to a negative value.		NOT logic: In normal logic, if A = ON, then B = OFF, and vice versa.
	Gain multiplier for reference frequencies given by current and/or voltage input or for analog output signals. $C = A \times B$		
	Adder for 2 signals or values. $C = A + B$ If B is negative then $C = A - B$ (acting as a subtractor).		

4.2 Drive Frequency Command Block

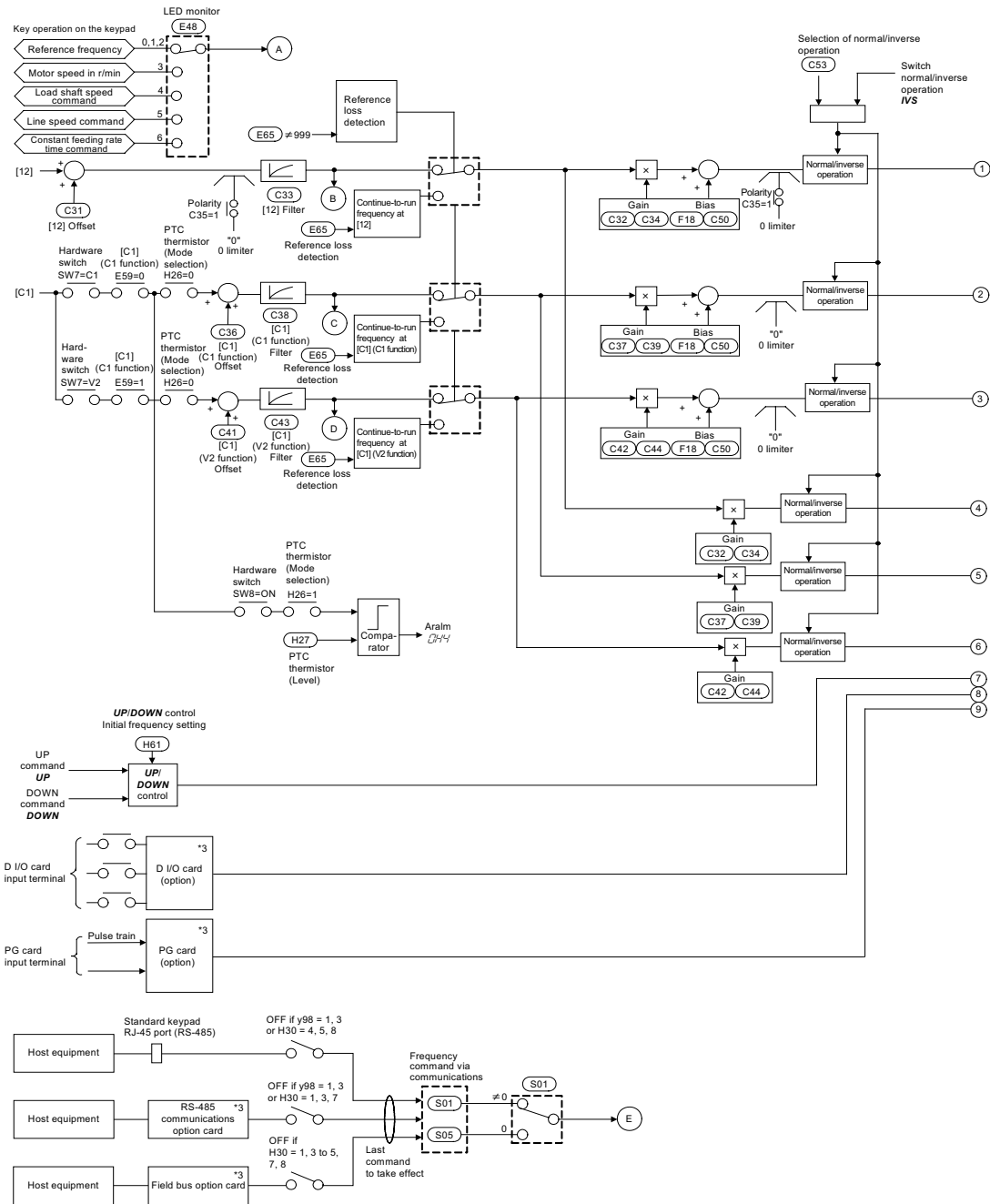

Figure 4.1.1 Drive Frequency Command Block -- Input Stage

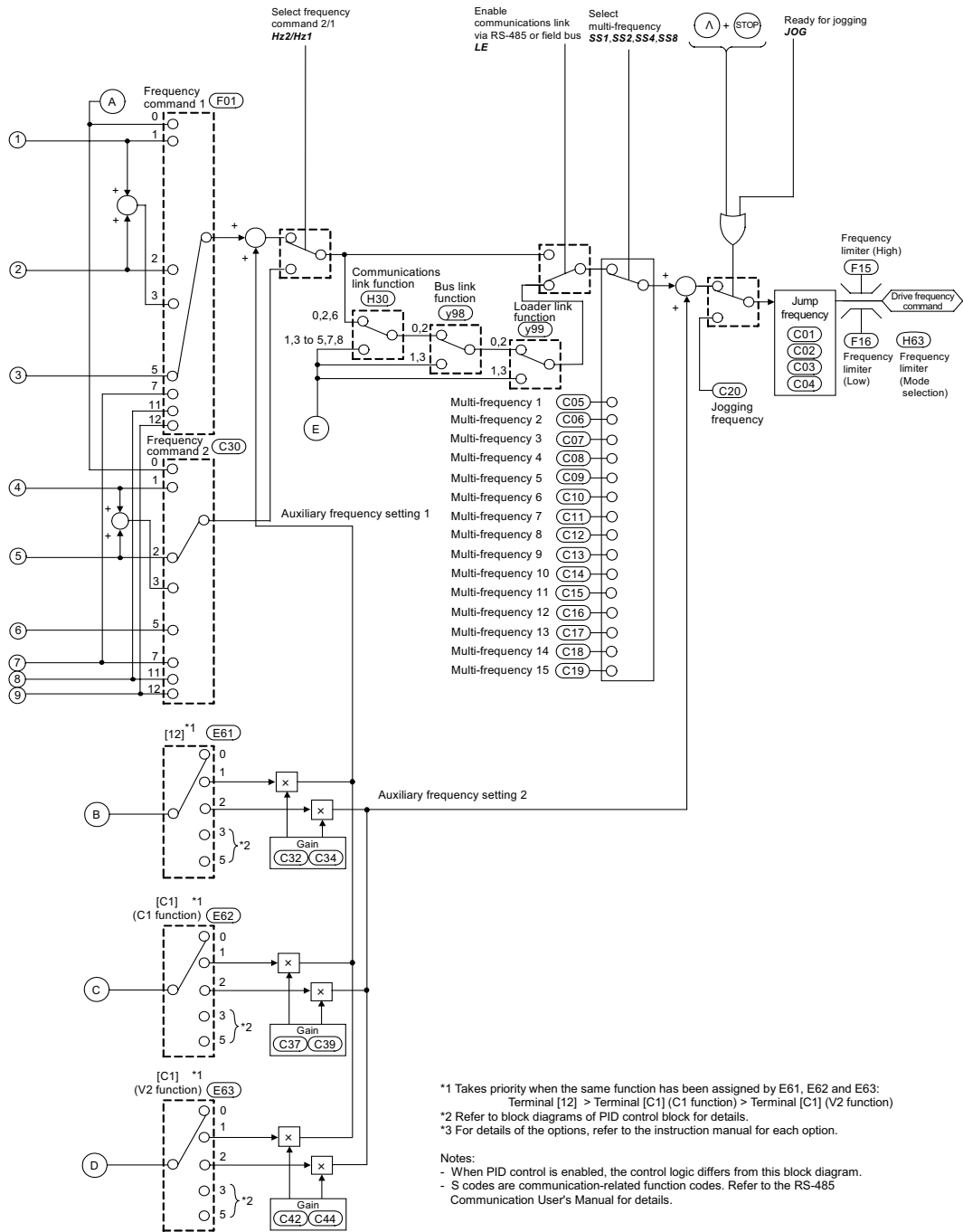

Figure 4.1.2 Drive Frequency Command Block -- Output Stage



This page is intentionally left blank.

Figures 4.1.1 and 4.1.2 show the processes that generate the internal drive frequency command through the various frequency command and switching steps by means of function codes. When the PID control is active (J01 = 1 to 3), the logic differs from that of this block diagram. Refer to Section 4.5 "PID Process Control Block" and Section 4.6 "PID Dancer Control Block."

Additional and supplemental information is given below.

- Frequency command sourcing by the $\hat{\wedge}$ / $\hat{\vee}$ keys operation on the keypad covers various command expression formats such as a load rotational speed and a line speed by specifying data of function code E48.
- The input terminal natively covers the -10 to $+10$ VDC analog frequency command. The function code C35 allows this terminal to be used as a unipolar input 0 to $+10$ VDC or a bipolar input -10 to $+10$ VDC. For the unipolar input, inserting the "0" limiter in the following process stage of the terminal input [12], modification of the reference frequency by the bias and gain, assures the reference frequency not to always be switched to the negative frequency command -- causing the reverse rotation of the motor.
- Setting slide switches SW7 and SW8 on the interface printed circuit board (interface PCB) and data of function codes E59 and H26 characterizes the analog input terminal [C1] for the current input (C1 function covering $+4$ to $+20$ mA DC), the voltage input (V2 function covering 0 to $+10$ VDC) or the PTC. If no input such as frequency command is applied to the terminal, the inverter makes of it as "0."
- Although the [C1] terminal can be switched to either the current input (C1 function) or the voltage input (V2 function), suitable adjustment of the analog input such as the offset, filter and gain should be processed by exclusively provided function codes.
- The command loss detection is only applicable to analog inputs of the terminals [12], [C1] (C1 function) and [C1] (V2 function). For the command loss detection, the continue-to-run frequency automatically switched to the reference frequency determined by what active frequency command is lost, however, the switched reference command may fluctuate due to the switching timing or the switched situation. For details, refer to the description of function code E65.
- Case that data setup for both the gain and bias will take effect concurrently is only available for the frequency command source 1 (F01). For the frequency command source 2 (C30) and auxiliary frequency command sources 1 and 2 (E61 to E63), only setup of the gain will take effect.
- Switching between normal and inverse operation is only effective for the reference frequency from the analog frequency command input signal (terminal [12], [C1] (C1 function) or [C1] (V2 function)). Note that the frequency command source set up by using the $\hat{\wedge}$ / $\hat{\vee}$ key is only valid for normal operation.
- Frequency commands by S01 and S05 for the communications link facility take different command formats as follows.
 - S01: the setting range is -32768 to $+32767$, where the maximum output frequency is obtained at ± 20000
 - S05: the setting range is 0.00 to 655.35 Hz in increments of 0.01 Hz
 - Basically, priority level for the command in S01 is higher than that in S05. If a value other than "0" is set in S01, the data set in S01 will take effect. If S01 is set at "0", data in S05 will take effect.
 - Refer to the RS-485 Communication User's Manual for details.
- The frequency limiter (Low) (F16) helps user select the inverter operation for either the output frequency is held at data of the frequency limiter (lower), or the inverter decelerates to stop the motor with reference frequency data of "0", by specifying the lower limiter (select) (H63.)

4.3 Drive Command Block

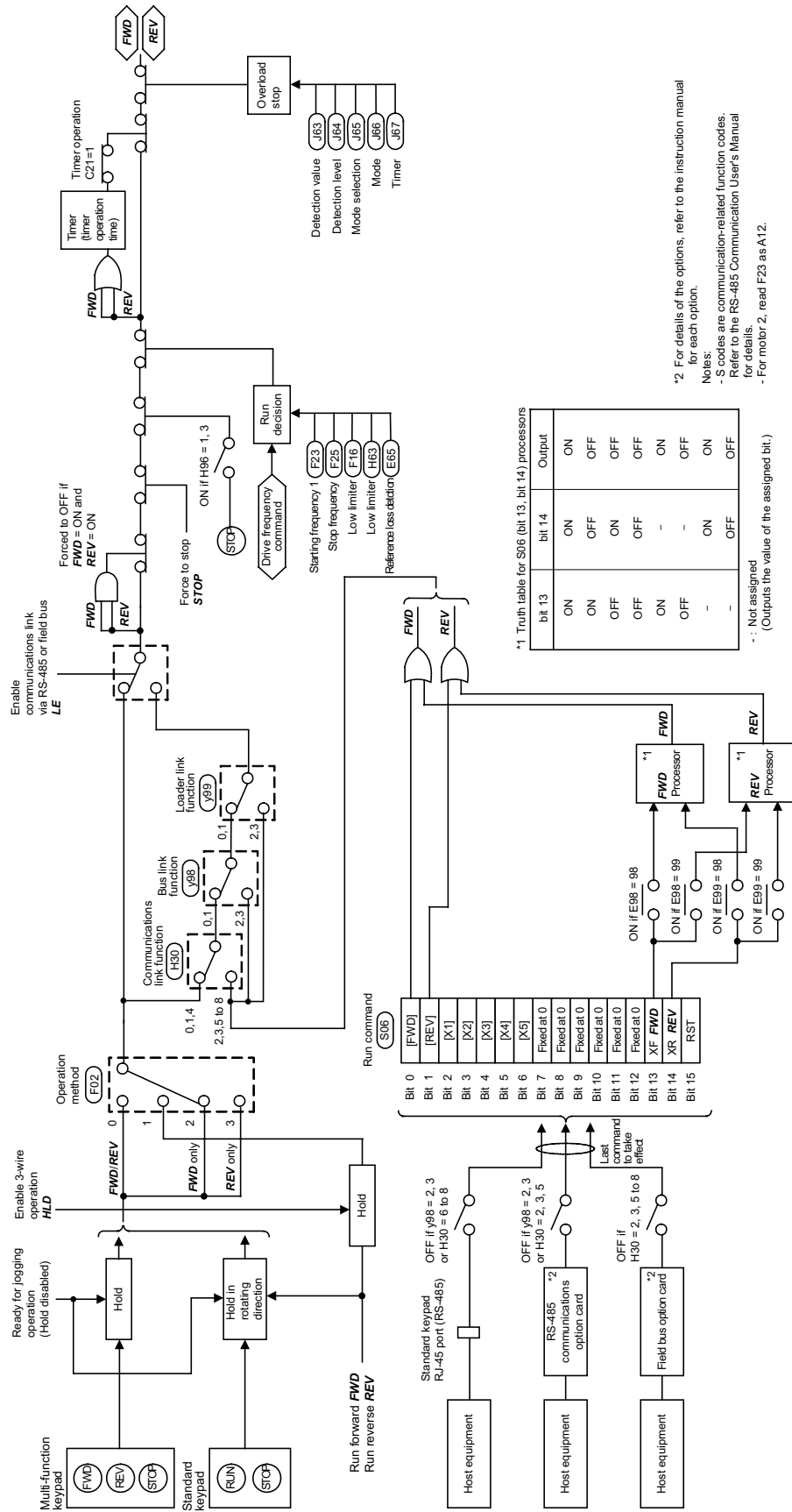











Figure 4.2 Drive Command Block
4-6

Figure 4.2 shows the processes that generate the final drive commands (**FWD**: Drive the motor in the forward direction and **REV**: Drive the motor in reverse direction) through the various run commands and switching steps by means of function codes.

Additional and supplemental information is given below.

- For the inverter operation given by the  /  key on the standard keypad, the generator holds the run command ON upon depression of the  key, decides the motor rotation direction according to the run forward command **FWD** or the run reverse command **REV**, and releases the hold state upon depression of the  key.

For the inverter operation given by the  /  /  key on the multi-function keypad, the generator holds the command ON upon depression of the  /  key, and releases the hold state upon depression of the  key.



- The 3-wire operation terminal command **HLD** holds the run forward terminal command **FWD** and the run reverse terminal command **REV**. This allows you to run the inverter in "3-Wire Operation." Refer to the function code E01 in Chapter 9 "FUNCTION CODES" for details.

If you do not assign the 3-wire operation command **HLD** to any digital input terminals, the "2-Wire Operation" using the commands **FWD** and **REV** will take effect.

- S06 (2-byte data of bit 15 through bit 0, programmable bitwise), the operation command via the communications link, includes:
 - Bit 0: assigned to **FWD**
 - Bit 1: assigned to **REV**
 - Bit 13 (XF) and bit 14 (XR): Programmable bits equivalent to the terminal inputs [FWD] and [REV]

In the block diagram, all of these are denoted as operation commands. The data setting for function code E98 to select the function of terminal [FWD] and E99 of [REV] determine which bit value should be selected as the run command. If bits 13 and 14 have the same setting to select the function of **FWD** or **REV**, the output of bit 13-14 processor logic will follow the truth table listed in Figure 4.2.

If either one of bits 13 and 14 is ON (= 1 as a logic value), the OR logic output will make the enable communications link command **LE** turn on. This is the same as with bit 0 and 1.

- If run commands **FWD** and **REV** are concurrently turned on, then logic forcibly makes the internal run commands **FWD** and **REV** turn off.
- If you set data, 1 or 3, up to the function code H96 (STOP key priority/Start Check) to make the  key priority effective, then depressing the  key forcibly turns off the internal run commands **FWD** and **REV**. In this case, the generator automatically replaces deceleration characteristics of the inverter for that of the linear deceleration regardless of the setting of H07 (Acceleration/deceleration pattern).
- If the reference frequency is lower than the starting frequency (F23) or the stop frequency (F25), then the internal run commands will be finally turned off according to the output of run decision logic, and the inverter decelerates to stop the motor.

The inverter is also equipped with the feature that if the frequency command specifies a reference frequency lower than that of specified by the lower limiter (F16 and H63), the logic turn the run command OFF automatically.

Further more, When the command loss detection is activated due to entering the abnormal frequency command, if E65 = 0 the inverter turns the run command OFF.

- For the timer driven operation, once inputting a run command, the timer starts countdown, the inverter automatically turns OFF the internal run command after the time elapsed, and releases the hold function in the keypad at same time.
- When the overload stop facility is enabled and an overload is detected, the inverter turns the run command OFF depending on data of the function code J65. To restart the inverter operation, once turn the run command OFF, and it ON again.

4.4 Control Block

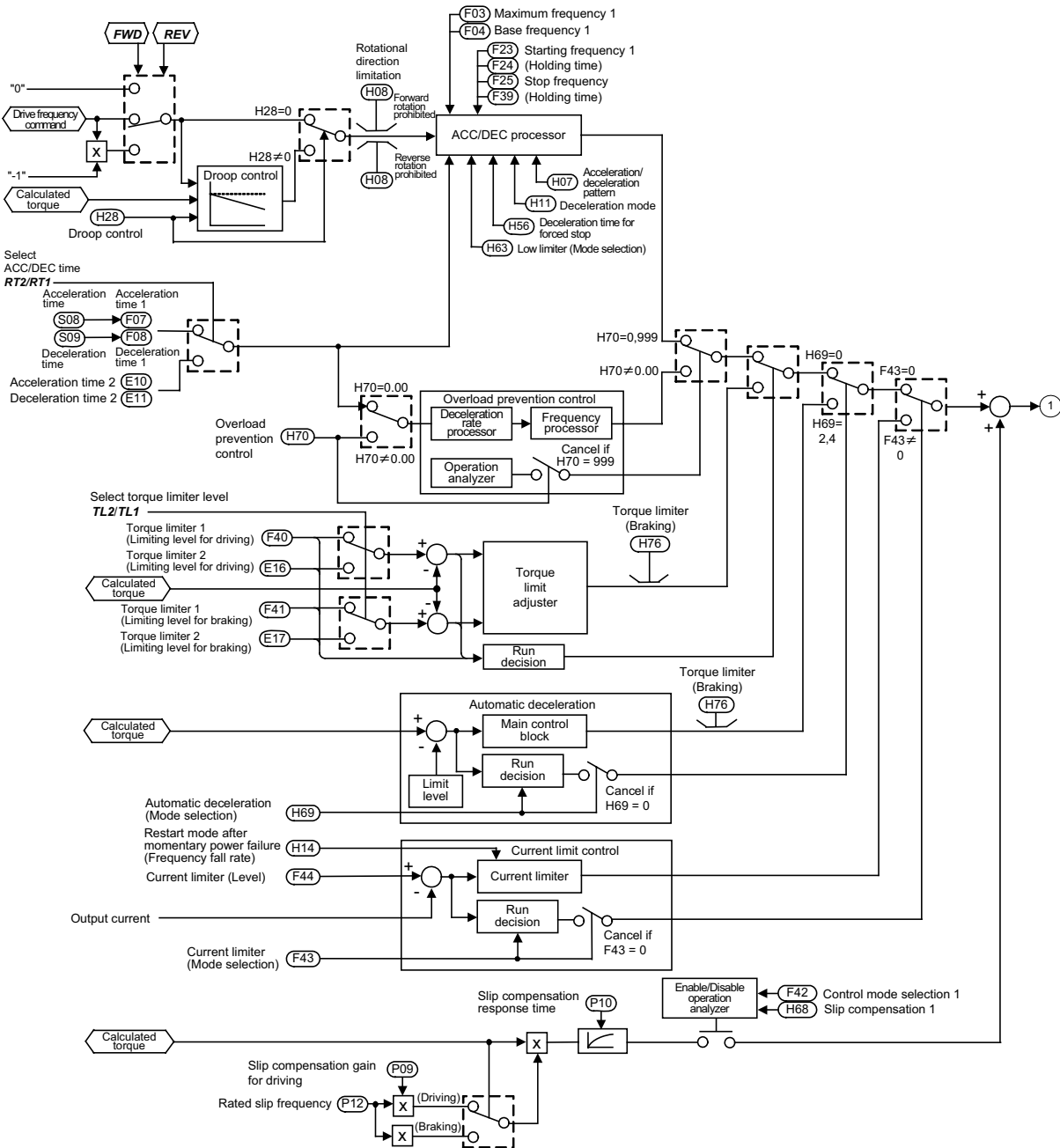
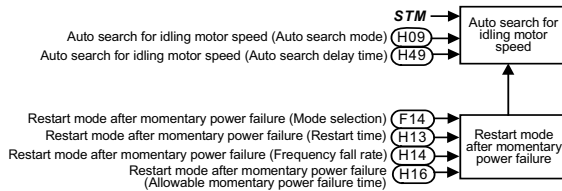
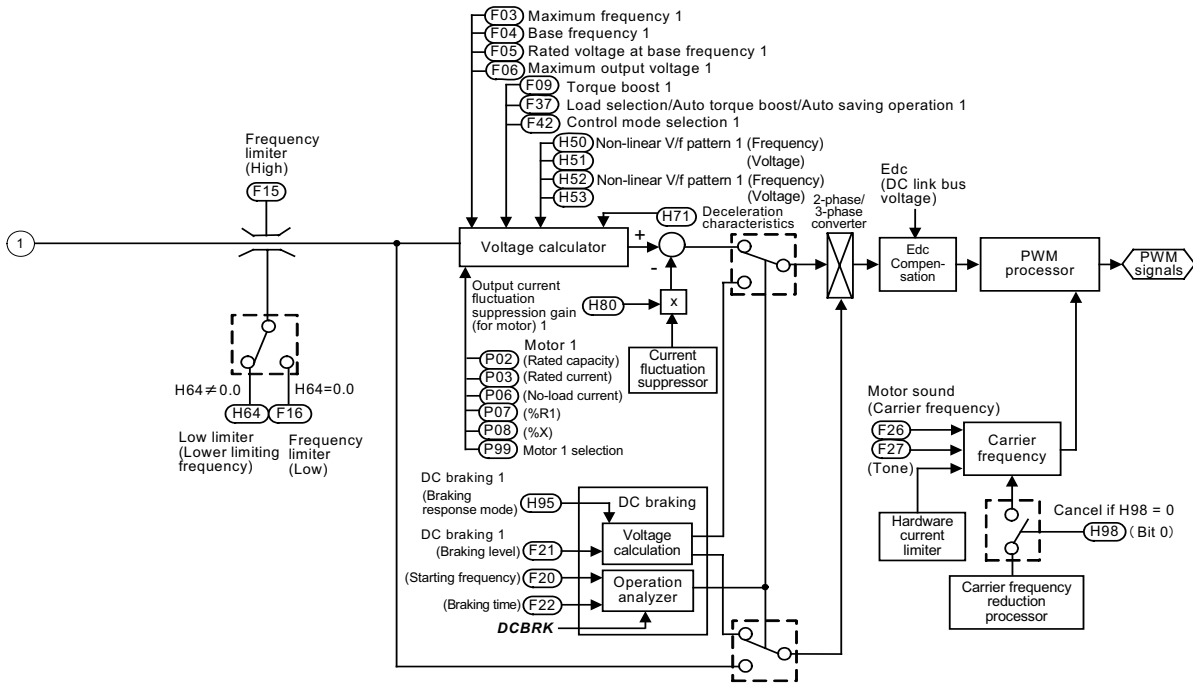
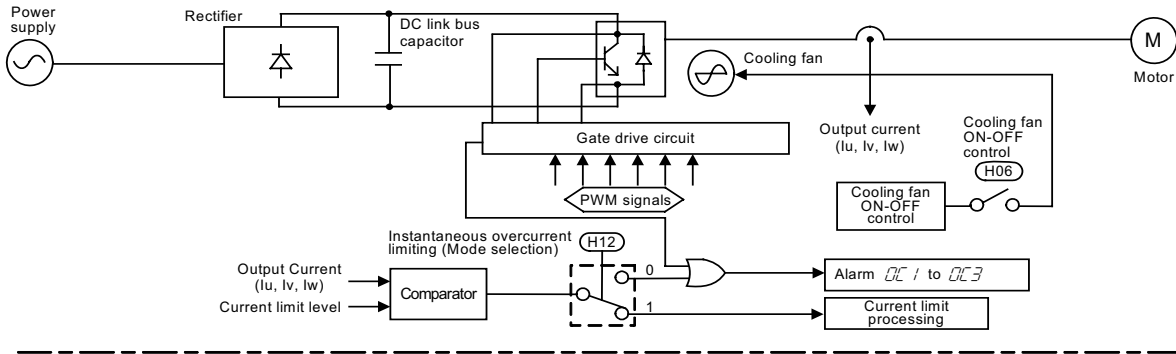

Figure 4.3.1 Control Block -- Input Stage



Note:
Function codes in the above control block are for motor 1. For motor 2, read the function codes for motor 1 as the function codes for motor 2, referring to the table below.

Function code for motor 1	F03	F04	F05	F06	F09	F20	F21	F22	F37	F42
Function code for motor 2	A01	A02	A03	A04	A05	A09	A10	A11	A13	A14

Function code for motor 1	H68	H80	P02	P03	P06	P07	P09	P10	P12	P99
Function code for motor 2	A40	A41	A16	A17	A20	A21	A23	A24	A26	A39

Figure 4.3.2 Control Block -- Output Stage



This page is intentionally left blank.

Figures 4.3.1 and 4.3.2 show schematic block diagrams -- input and output stages respectively that explain the processes in which the inverter drives the motor according to the final run command *FWD* or *REV* and the drive frequency command sent from the drive frequency command block or the PID control block.

Additional and supplemental information is given below.

- The logic shown in the upper left part of the block diagram processes the final reference frequency so that it is inverted ($\times(-1)$) for reverse rotation of the motor or is replaced with 0 (zero) for stopping the motor.
- If the droop control (H28) is enabled, the droop characteristics owing a load torque will take effect.
- The rotation direction limiter (H08) limits polarity (forward or reverse) of the final frequency command (reference) and helps the inverter take effect of anti-forward rotation or anti-reverse rotation function.
- The acceleration/deceleration processor determines the output frequency of the inverter by referring to data of related function codes. If the output frequency exceeds the upper limit given by the frequency limiter (High) (F15), the controller automatically limits the output frequency at the upper limit.
- If the overload prevention control is enabled, the logic automatically switches the output frequency to the enabled side of overload suppression control and controls the output frequency accordingly.
- Upon activating of the torque limiter the inverter automatically switch its output frequency to ones of the torque limiter and continues to run. The terminal command *TL2/TL1* switches the level of torque limiting. For the braking torque, it limits the frequency control amount according to data of the function code H76.
- Upon activating of regeneration power suppression, the inverter automatically switches its output frequency to ones of the regeneration power suppression mode and continues to run, while lengthening the deceleration time consequently more than specified one. For the braking torque, it limits the frequency control amount according to data of the function code H76 as well as the torque limiting.
- Upon activating of the current limiter, the inverter switches automatically its output frequency to ones of the current limiter, and continues to run.
- Define the slip compensation involving the rated slip of the motor (P12), the slip compensation gain for driving (P09) and braking (P11), separately for driving and braking, and also the response to the slip compensation as a response time to the slip compensation (P10).
- The voltage calculator determines the output voltage of the inverter. The calculator adjusts the output voltage to control the motor output torque.
- If the DC braking control is enabled, the logic switches the voltage and frequency control components to the ones determined by the DC braking block to feed the proper DC current to the motor for the DC braking.

4.5 PID Process Control Block

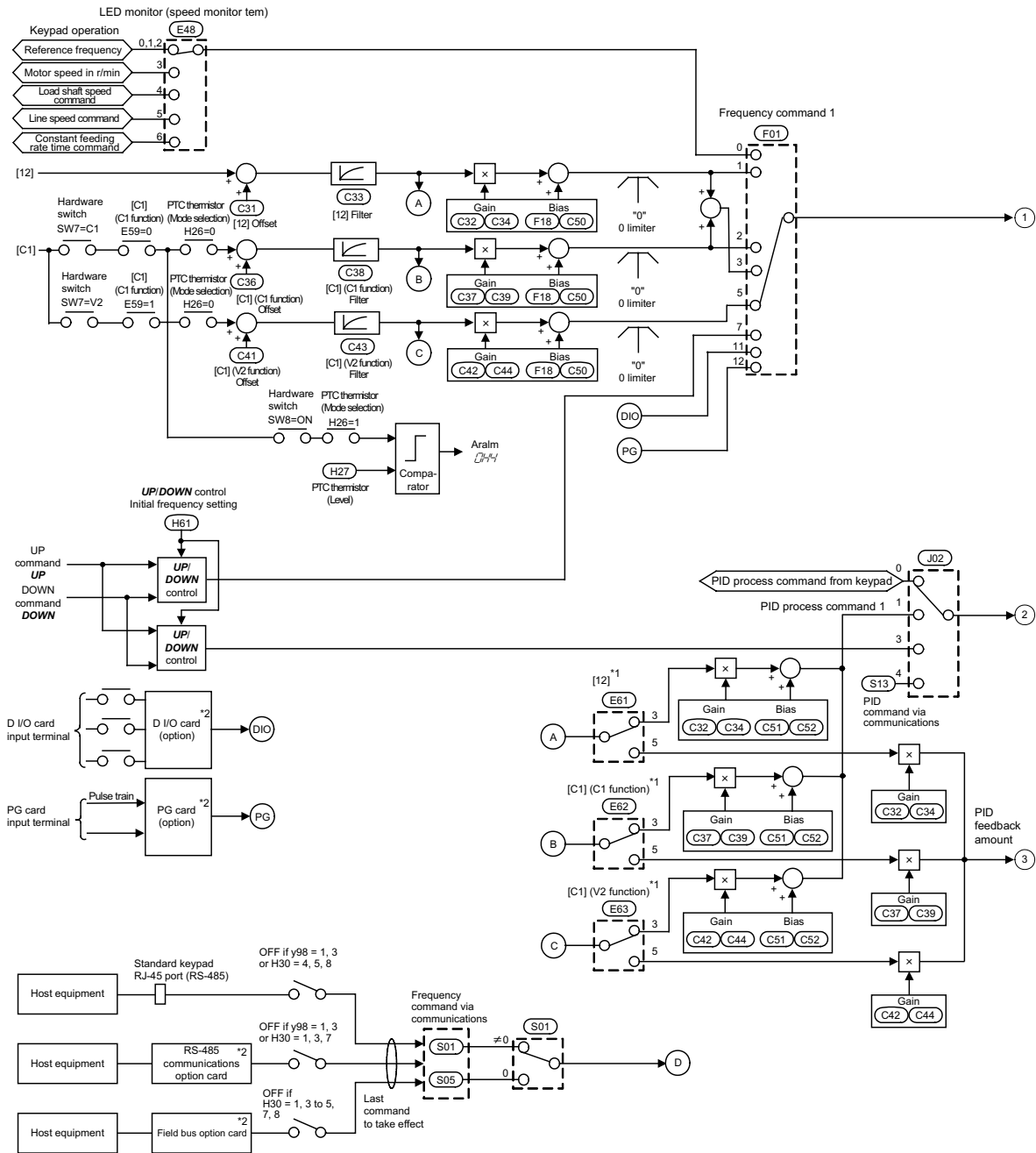

Figure 4.4.1 PID Process Control Block -- Input Stage

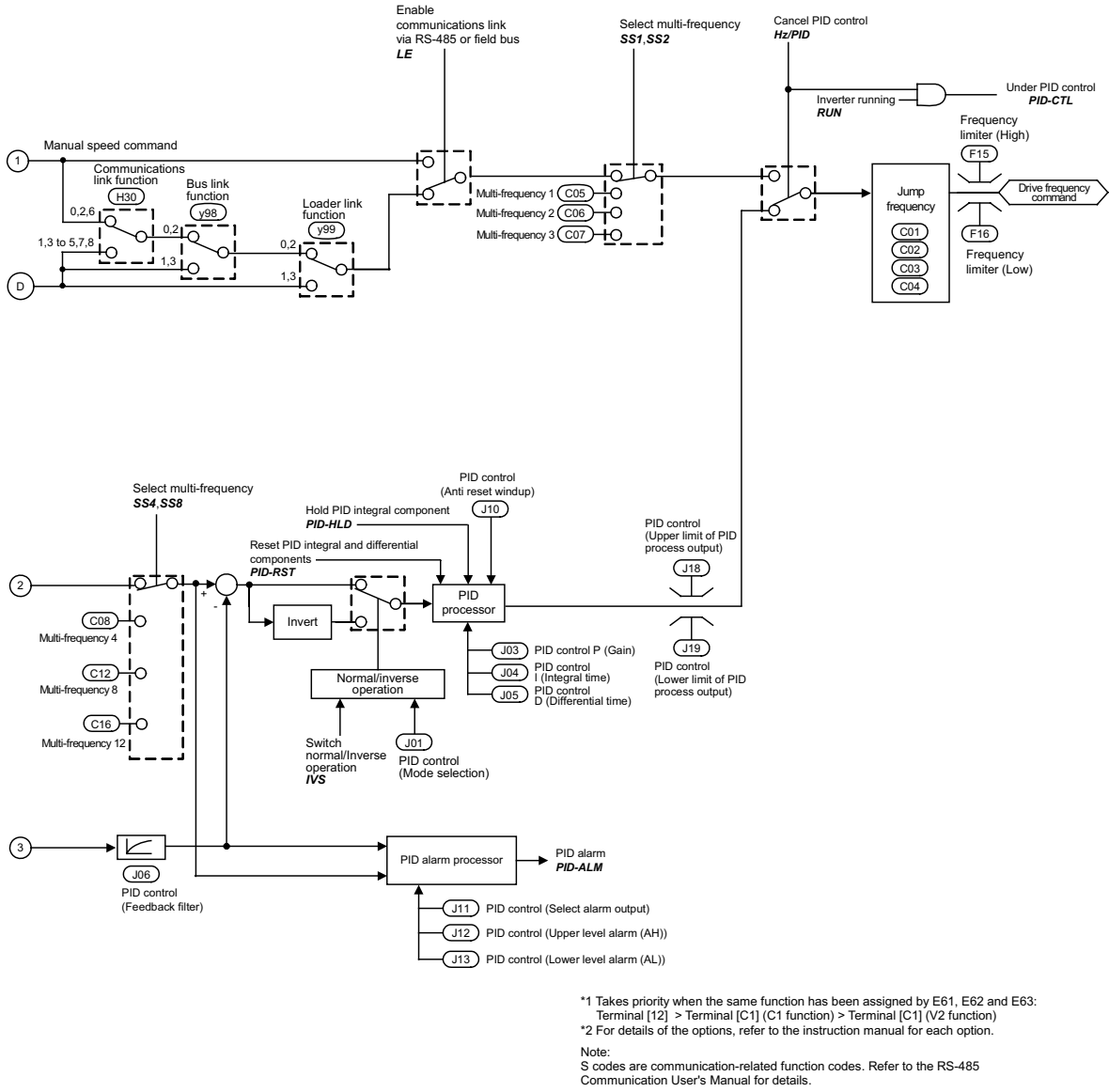

Figure 4.4.2 PID Process Control Block -- Output Stage

This page is intentionally left blank.

Figures 4.4.1 and 4.4.2 show block diagrams of the PID control block -- input and output stages respectively, when the PID process control is enabled (J01= 1 or 2). The logic shown generates the <drive frequency command> according to the PID process command source and PID feedback source, PID conditioner, and the selected frequency command source for a manual speed command.

Additional and supplemental information is given below.

- This logic disables settings of the frequency command 2 (C30) and auxiliary frequency command 1 and 2 (E60 to E62) as manual frequency commands, and the command loss detection, switching between the normal or inverse operation.
- The multi-frequency commands 1, 2, and 3 are only applicable to the manual speed command.
- Refer to Section 4.2 "Drive Frequency Command Block" for explanations of common items.
- For selecting analog input (terminal [12], [C1] (C1 function), or [C1] (V2 function)) as the PID process command source, you need to set data up for function codes E61 to E62 and J02.
- The multi-frequency command 4 (C08), 8 (C12) and 12 (C16) are only applicable to PID process command.
- To switch the operation between normal and inverse, the logic inverts the polarity of difference between the PID command and its feedback (turning the *INV* command on/off, or setting data J01 at 1 or 2).

4.6 PID Dancer Control Block

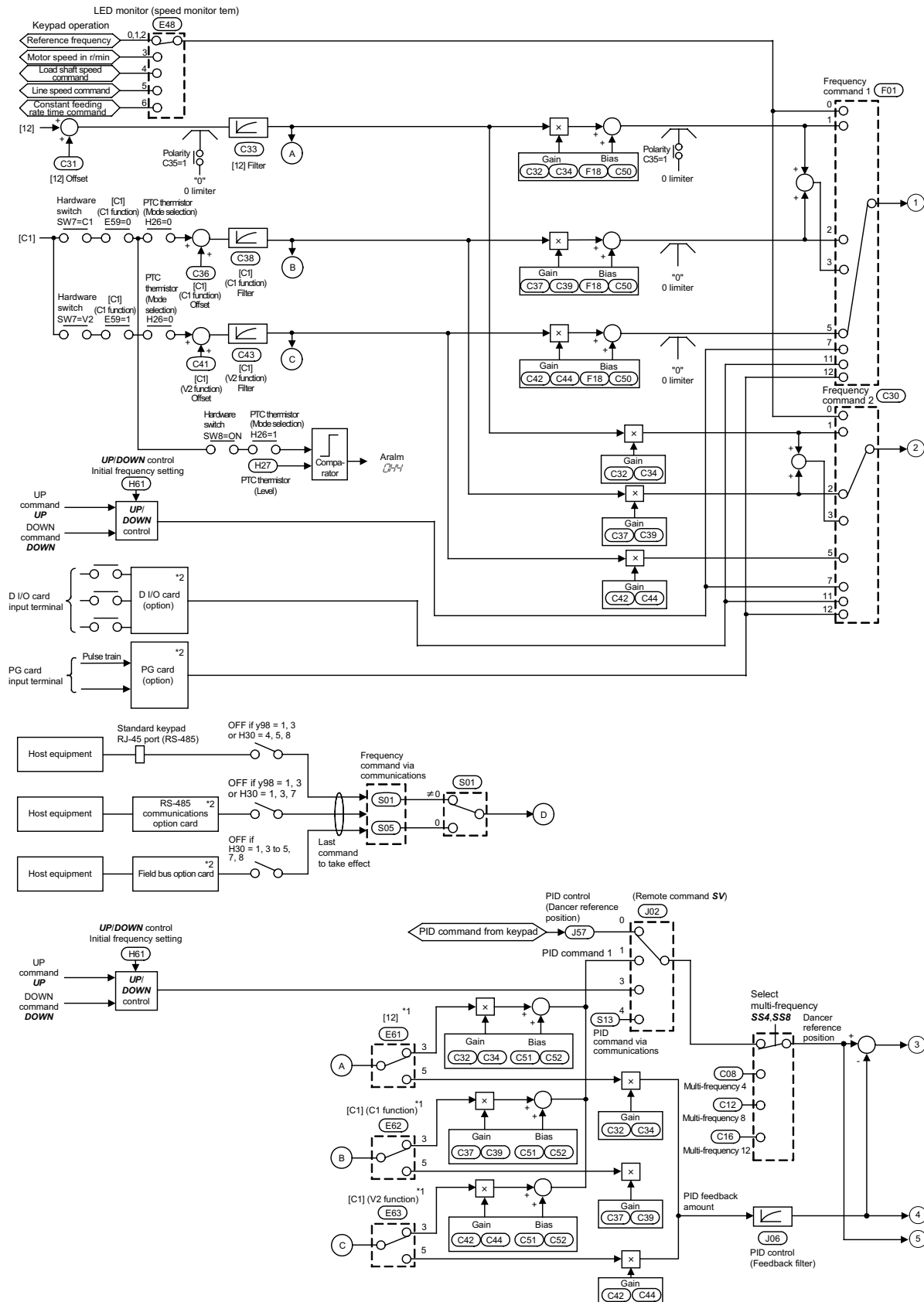

Figure 4.5.1 PID Dancer Control Block -- Input Stage

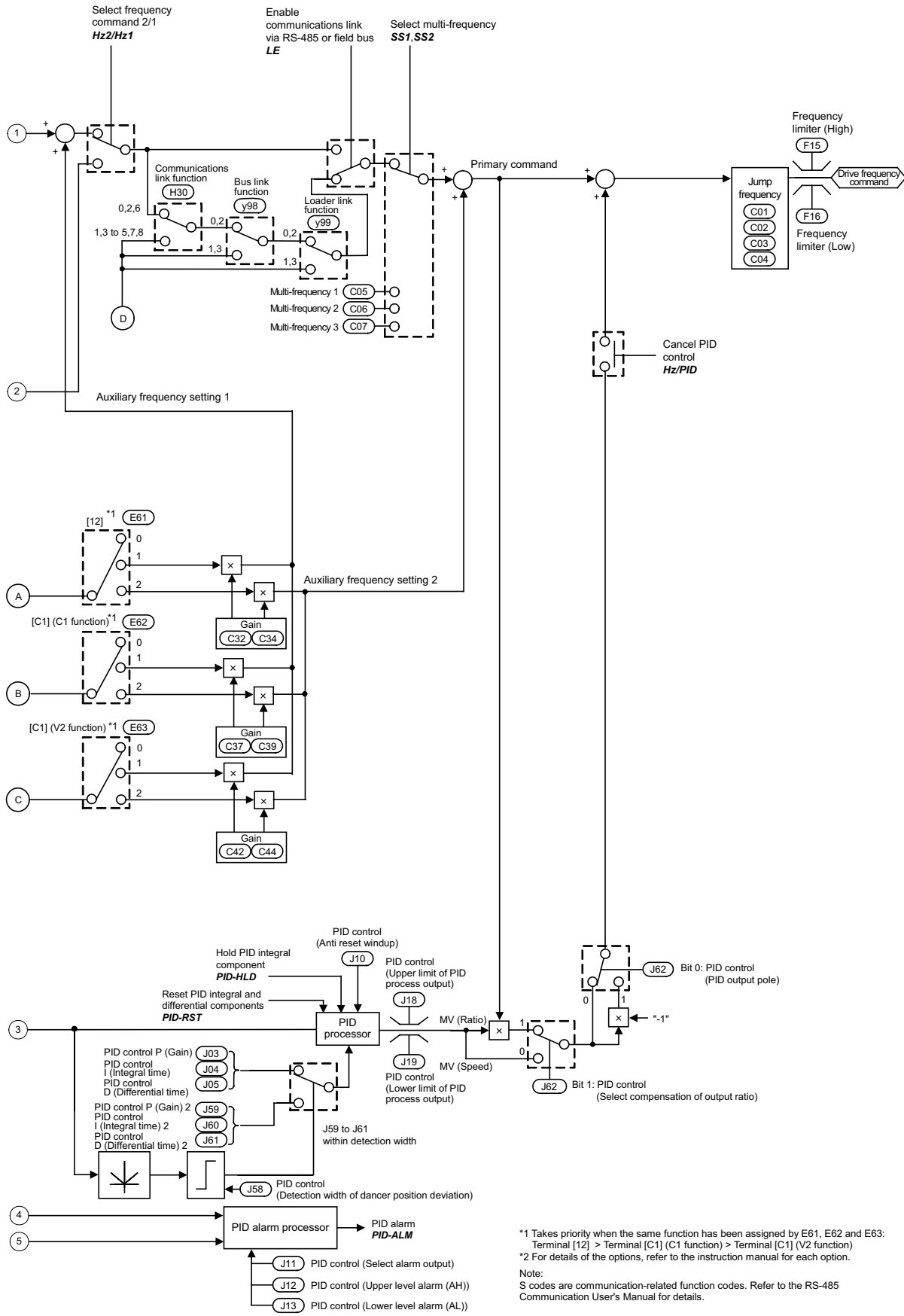

Figure 4.5.2 PID Dancer Control Block -- Output Stage

Figures 4.5.1 and 4.5.2 show block diagrams of the PID control block -- input and output stages respectively when the PID dancer control is enabled (J01 = 3). The logic shown generates the <Drive frequency command> according to the various PID command (such as the dancer reference position) and its PID feedback, the primary frequency command and their switching means.

Additional and supplemental information is given below.

- For the primary frequency command, the inverter disables the command loss detection, and switching between the normal and inverse operation.
- Multi-frequency commands 1, 2 and 3 are exclusively applicable to the primary frequency.
- For logics common to the drive frequency command block, refer to 4.2 "Drive Frequency Command Block."
- To use any of analog input terminals [12], [C1] (C1 function) and [C1] (V2 function) for a PID command (dancer reference position) input, be sure properly configure data of function codes E60, E61, E62 and J02.
- Multi-frequency commands 4, 8 and 12 are exclusively applicable to the PID command (dancer reference position).
- The output of dancer reference position bandwidth detector switches PID constant set of the PID control between (J03, J04 and J05) and (J59, J60 and J61).
- This logic allows the inverter to select either controlling the output of PID processor in a ratio (%) or add/subtract of the frequency (Hz) to the primary frequency command.
- The terminal command of PID cancel **Hz/PID** cancels the compensation of PID dancer control and makes the inverter also possible to run with the primary frequency command.

4.7 FM Output Selector

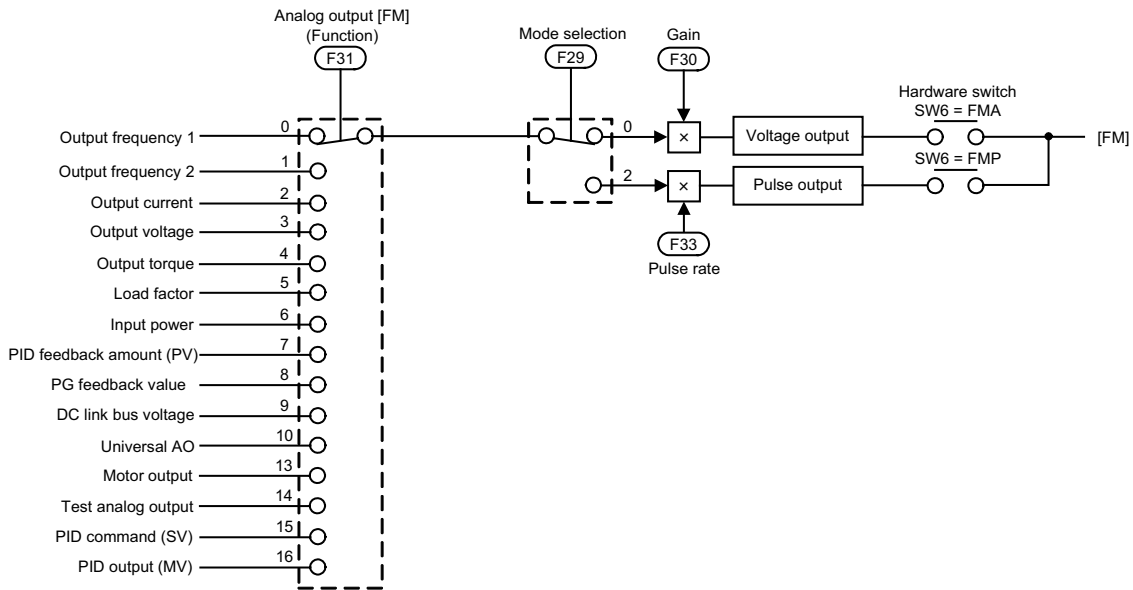

Figure 4.6 Terminal [FM] Output Selector

The block diagram in Figure 4.6 shows the process for selecting and processing the internal signals to be output to analog/pulse output terminals [FM].

Combination of function code F29 data and selection of the hardware switch SW6 on the interface PCB specifies a property of the analog/pulse output [FM] terminal for an analog voltage or a pulse train.

To select information to be transferred to the analog/pulse output terminal [FM], use the function code F31. For its analog output (voltage output), the function code F30 can define the full scale of the output that just matches with the full scale of the connected voltmeter in the external equipment. For the pulse train output, the function code F33 defines rate of the output (pulse count/s for the 100% output) matching resolution of the counter connected in the external equipment.

Setting function code F31 to "10: Universal AO" enables data output from the host equipment via the communications link on [FM].

The calibration analog output (F31 = 14) refers to an output of the [FM]'s full-scale voltage or pulse that adjusts the scale of the connected meter.

Chapter 5

RUNNING THROUGH RS-485 COMMUNICATION

This chapter describes an overview of inverter operation through the RS-485 communications facility. Refer to the RS-485 Communication User's Manual for details.

Contents

5.1	Overview on RS-485 Communication	5-1
5.1.1	RS-485 common specifications (standard and optional).....	5-2
5.1.2	RJ-45 connector pin assignment for standard RS-485 communications port.....	5-3
5.1.3	Pin assignment for optional RS-485 Communications Card.....	5-4
5.1.4	Cable for RS-485 communications port.....	5-4
5.1.5	Communications support devices.....	5-5
5.2	Overview of FRENIC Loader	5-6
5.2.1	Specifications	5-6
5.2.2	Connection	5-7
5.2.3	Function overview.....	5-7
5.2.3.1	Setting of function code	5-7
5.2.3.2	Multi-monitor	5-8
5.2.3.3	Running status monitor	5-9
5.2.3.4	Test-running	5-10
5.2.3.5	Real-time trace—Displaying running status of an inverter in waveforms	5-11

5.1 Overview on RS-485 Communication

Detaching the standard keypad from the FRENIC-Multi inverter and using the standard RJ-45 connector (modular jack) as an RS-485 communications port brings about the following enhancements in functionality and operation:

- Remote operation from a keypad at the remote location

Using an extension cable to connect the standard keypad or an optional multi-function keypad to the RJ-45 port allows you to mount the keypad on a panel located far from the inverter, enabling remote operation. The maximum length of the extension cable is 20 m.

- Operation by FRENIC Loader

The Windows-based PC can be connected to the standard RS-485 communications port via a suitable converter. Through the RS-485 communications facility, you may run FRENIC Loader on the PC to edit the function code data and monitor the running status information of the inverter.

- Control via host equipment

You can use a personal computer (PC) or a PLC as host (higher-level) equipment and through it control the inverter as its subordinate device.

Protocols for managing a network including inverters include the Modbus RTU protocol (compliant to the protocol established by Modicon Inc.) that is widely used in FA markets and the Fuji general-purpose inverter protocol that supports the FRENIC-Multi and conventional series of inverters.



Connecting the keypad automatically switches to the keypad protocol; there is no need to modify the function code setting.

When using FRENIC Loader, which requires a special protocol for handling Loader commands, you need to set up some communication function codes accordingly.

For details, refer to the FRENIC Loader Instruction Manual.

Further, another RS-485 communications port can be added by mounting an optional RS-485 Communications Card onto the FRENIC-Multi inverter. This additional communications link can be used only as a port for host equipment, not used for a keypad or FRENIC Loader.



For details of RS-485 communication, refer to the RS-485 Communication User's Manual.

5.1.1 RS-485 common specifications (standard and optional)

Items	Specifications		
Protocol	FGI-BUS	Modbus RTU	Loader commands (supported only on the standard version)
Compliance	Fuji general-purpose inverter protocol	Modicon Modbus RTU-compliant (only in RTU mode)	Dedicated protocol (Not disclosed)
No. of supporting stations	Host device: 1 Inverters: Up to 31		
Electrical specifications	EIA RS-485		
Connection to RS-485	RJ-45 connector (standard) or terminal block (optional)		
Synchronization	Asynchronous start-stop system		
Transmission mode	Half-duplex		
Transmission speed	2400, 4800, 9600 19200 or 38400 bps		
Max. transmission cable length	1600 ft (500 m)		
No. of logical station addresses available	1 to 31	1 to 247	1 to 255
Message frame format	FGI-BUS	Modbus RTU	FRENIC loader
Frame synchronization	SOH (Start Of Header) character detection	Detection of no-data transmission time for 3-byte period	Start code 96H detection
Frame length	Normal transmission: 16 bytes (fixed) High-speed transmission: 8 or 12 bytes	Variable length	Variable length
Max. transfer data	Write: 1 word Read: 1 word	Write: 50 words Read: 50 words	Write: 41 words Read: 41 words
Messaging system	Polling/Selecting/Broadcast		Command message
Transmission character format	ASCII	Binary	Binary
Character length	8 or 7 bits (selectable by the function code)	8 bits (fixed)	8 bits (fixed)
Parity	Even, Odd, or None (selectable by the function code)		Even (fixed)
Stop bit length	1 or 2 bits (selectable by the function code)	No parity: 2 bits/1 bit Even or Odd parity: 1 bit Select by parity setting.	1 bit (fixed)
Error checking	Sum-check	CRC-16	Sum-check

5.1.2 RJ-45 connector pin assignment for standard RS-485 communications port

The port designed for a standard keypad uses an RJ-45 connector having the following pin assignment:

Pin	Signal name	Function	Remarks
1 and 8	Vcc	Power source for the keypad	5 V power lines
2 and 7	GND	Reference potential	Grounding pins
3 and 6	NC	Not used.	No connection
4	DX-	RS-485 data (-)	Built-in terminating resistor: 112 Ω
5	DX+	RS-485 data (+)	Open/close by SW3*

* For details about SW3, refer to "[Setting up the slide switches](#)" in Section 8.3.1 "Terminal functions."

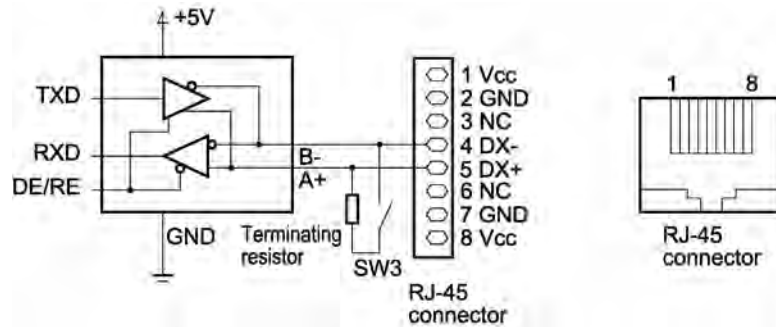

Pins 1, 2, 7, and 8 on the RJ-45 connector are exclusively assigned to power supply and grounding for keypads. When connecting other devices to the RJ-45 connector, take care not to use those pins. Failure to do so may cause a short-circuit hazard.

Do not connect the FVR-E11S series of inverters since the pin assignment of the keypad is different from that of the FRENIC-Multi series. Doing so could result in an inverter damage.

5.1.3 Pin assignment for optional RS-485 Communications Card

The RS-485 Communications Card has two RJ-45 connectors for multi-drop connection. Each RJ-45 connector has the pin assignment as listed below.

Pin	Signal name	Function	Remarks
1, 3, 6, 7 and 8	NC	No connection (Reserved for keypad power source.)	—
2	SD	Shield terminal	Internally connecting SDs
4	DX-	RS-485 data (-)	Built-in terminating resistor: 112Ω Open/close by SW9*
5	DX+	RS-485 data (+)	

* For details about SW9, refer to RS-485 Communication User's Manual.

5.1.4 Cable for RS-485 communications port

For connection with the RS-485 communications port, be sure to use an appropriate cable and a converter that meet the applicable specifications.

 For details, refer to the RS-485 Communication User's Manual.

5.1.5 Communications support devices

This section provides information necessary for connection of the inverter to host equipment having no RS-485 communications port such as a PC or for configuring a multi-drop connection.

[1] Communications level converter

Most personal computers (PC) are not equipped with an RS-485 communications port but RS-232C and USB ports. To connect a FRENIC-Multi inverter to a PC, therefore, you need to use an RS-232C—RS-485 communications level converter or a USB—RS-485 interface converter. For correct running of the communications facility to support FRENIC-Multi series of inverters, be sure to use one of the recommended converters listed below.

Recommended converters

KS-485PTI (RS-232C—RS-485 communications level converter)

USB-485I RJ45-T4P (USB—RS-485 interface converter)

Supplied by SYSTEM SACOM Corporation.

[2] Requirements for the cable

Use an off-the-shelf 10BASE-T LAN cable (ANSI/TIA/EIA-568A category 5 compliant, straight type).



The RJ-45 connector has power source pins (pins 1, 2, 7 and 8) exclusively assigned for keypads. When connecting other devices to the RJ-45 connector, take care not to use those pins. Failure to do so may cause a short-circuit hazard.

[3] Multi-drop adapter

To connect a FRENIC-Multi inverter to a network in a multi-drop configuration with a LAN cable that has RJ-45 as the communications connector, use a multi-drop adapter for the RJ-45 connector.

Recommended multi-drop adapter

Model MS8-BA-JJJ made by SK KOHKI Co., Ltd.

[4] RS-485 Communications Card

To equip your inverter with another RS-485 communications port in addition to the standard RS-485 communications port, you need to install this optional card. Note that you cannot use FRENIC Loader through the optional RS-485 communications port.

RS-485 Communications Card (option)

For details, refer to the RS-485 Communications Card "OPC-E1-RS" Installation Manual.



For more details through Section 5.1.5, refer to the RS-485 Communication User's Manual.

5.2 Overview of FRENIC Loader

FRENIC Loader is a software tool that supports the operation of the inverter via an RS-485 communications link. It allows you to remotely run or stop the inverter, edit, set, or manage the function codes, monitor key parameters and values during operation, as well as monitor the running status (including alarm information) of the inverters on the RS-485 communications network.

 For details, refer to the FRENIC Loader Instruction Manual.

5.2.1 Specifications

Item		Specifications (White on black indicates factory default)	Remarks
Name of software		FRENIC Loader Ver. 4.0.0.0 or later	
Supported inverter		FRENIC-Multi series FRENIC-Eco series FRENIC-Mini series	(Note 1)
No. of supported inverters		Up to 31	
Recommended cable		10BASE-T cable with RJ-45 connectors compliant with EIA568	
Operating environment	CPU	Intel Pentium III 600 MHz or later	(Note 2)
	OS	Microsoft Windows 2000 Microsoft Windows XP	
	Memory	32 MB or more RAM	64 MB or more is recommended
	Hard disk	5 MB or more free space	
	COM port	RS-232C or USB	Conversion to RS-485 communication required to connect inverters
	Monitor resolution	XVGA (800 x 600) or higher	1024 x 768, 16-bit color or higher is recommended
Transmission requirements	COM port	COM1 , COM2, COM3, COM4, COM5, COM6, COM7, COM8	PC COM ports assigned to Loader
	Transmission rate	38400, 19200 , 9600, 4800 and 2400 bps	19200 bps or more is recommended. (Note 3)
	Character length	8 bits	Prefixed
	Stop bit length	1 bit	Prefixed
	Parity	Even	Prefixed
	No. of retries	None or 1 to 10	No. of retry times before detecting communications error
	Timeout setting	(100 ms, 300 ms, 500 ms), (1.0 to 9.0 s) or (10.0 to 60.0 s)	This setting should be longer than the response interval time set by function code y09 of the inverter.

(Note 1) FRENIC Loader cannot be used with inverters that do not support SX protocol (protocol for handling Loader commands).

With special order-made inverters, FRENIC Loader may not be able to display some function codes normally.

To use FRENIC Loader on FRENIC-Mini series of inverters, an RS-485 Communications Card (Option: OPC-C1-RS) is required.

- (Note 2) Use a PC with as high a performance as possible, since some slow PCs may not properly refresh the operation status monitor and Test-run windows.
- (Note 3) To use FRENIC Loader on a network where a FRENIC-Mini inverter is also configured, choose 19200 bps or below.

5.2.2 Connection

By connecting a number of inverters to one PC, you can control one inverter at a time or a number of inverters simultaneously. You can also simultaneously monitor a number of inverters on the multi monitor.

 For how to connect a PC to one or more inverters, refer to the RS-485 Communication User's Manual.

5.2.3 Function overview

5.2.3.1 Setting of function code

You can set, edit, and check the setting of the inverter's function code data.

List and Edit

In List and edit, you can list and edit function codes with function code No., name, set value, set range, and factory default.

You can also list function codes by any of the following groups according to your needs:

- Function code group
- Function codes that have been modified from their factory defaults
- Result of comparison with the settings of the inverter
- Result of search by function code name
- User-specified function code set

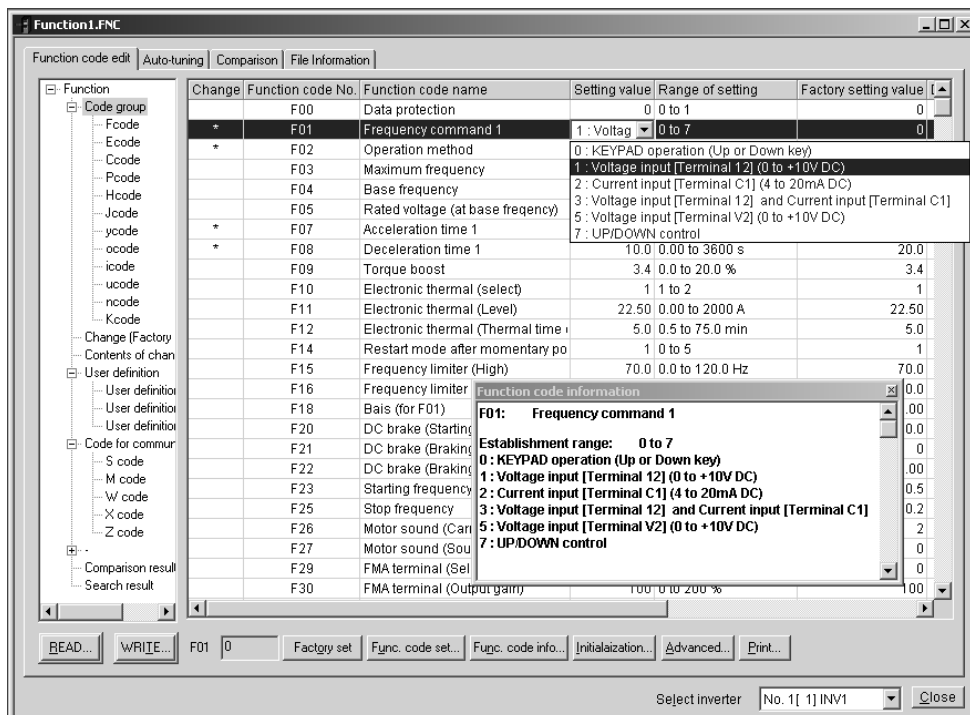

Comparison

You can compare the function code data currently being edited with that saved in a file or stored in the inverter.

To perform a comparison and review the result displayed, click the **Comparison** tab and then click the **Compared with inverter** tab or click the **Compared with file** tab, and specify the file name.

The result of the comparison will be displayed also in the Comparison Result column of the list.

File information

Clicking the **File information** tab displays the property and comments for identifying the function code editing file.

(1) Property

Shows file name, inverter model, inverter's capacity, date of readout, etc.

(2) Comments

Displays the comments you have entered. You can write any comments necessary for identifying the file.

5.2.3.2 Multi-monitor

This feature lists the status of all the inverters that are marked "connected" in the configuration table.

Multi-monitor

Allows you to monitor the status of more than one inverter in a list format.

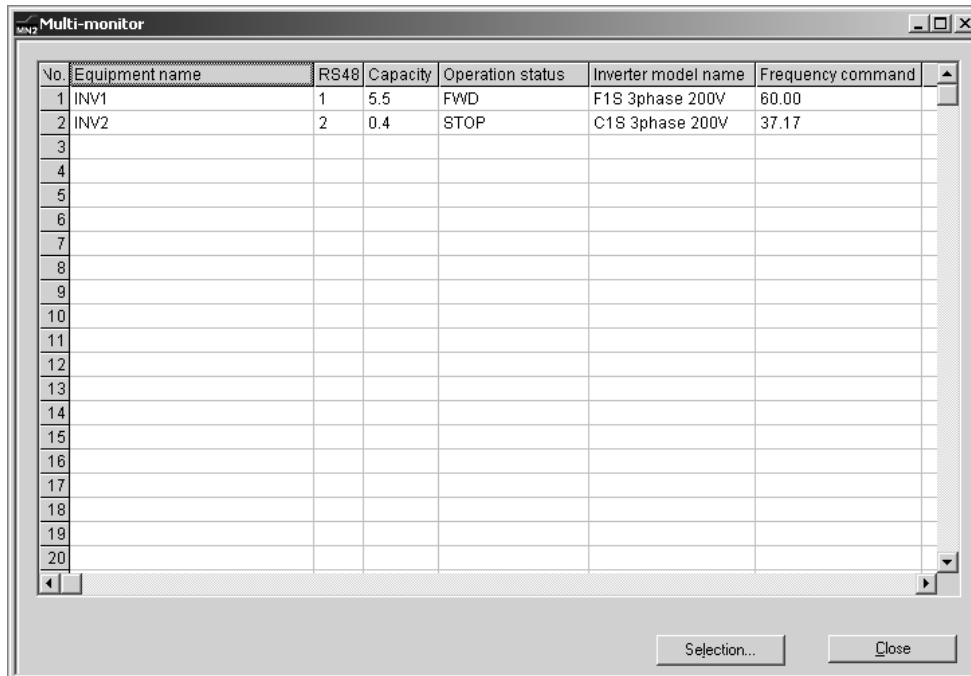

The screenshot shows a window titled "Multi-monitor" with a table containing the following data:

No.	Equipment name	RS48	Capacity	Operation status	Inverter model name	Frequency command
1	INV1	1	5.5	FWD	F1S 3phase 200V	60.00
2	INV2	2	0.4	STOP	C1S 3phase 200V	37.17
3						
4						
5						
6						
7						
8						
9						
10						
11						
12						
13						
14						
15						
16						
17						
18						
19						
20						

At the bottom of the window, there are two buttons: "Selection..." and "Close".

5.2.3.3 Running status monitor

The running status monitor offers four monitor functions: I/O monitor, System monitor, Alarm monitor, and Meter display. You can choose an appropriate monitoring format according to the purpose and situation.

I/O monitor

Allows you to monitor the ON/OFF states of the digital input signals to the inverter and the transistor output signals.

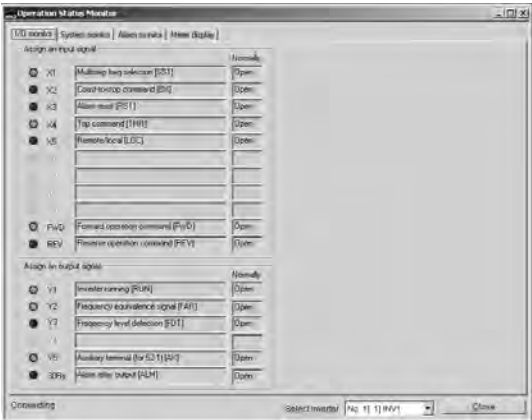

System monitor

Allows you to check the inverter’s system information (version, model, maintenance information, etc.).

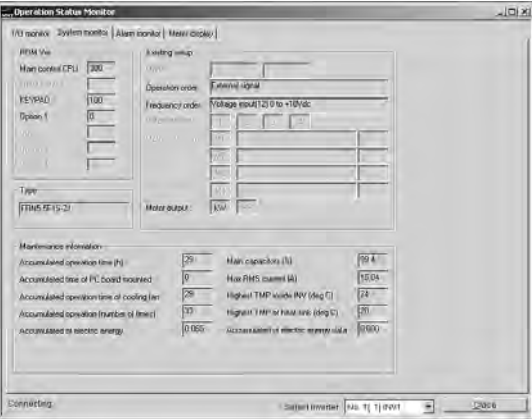

Alarm monitor

The alarm monitor shows the alarm status of the selected inverter. In this window you can check the details of the alarm currently occurs and related information.

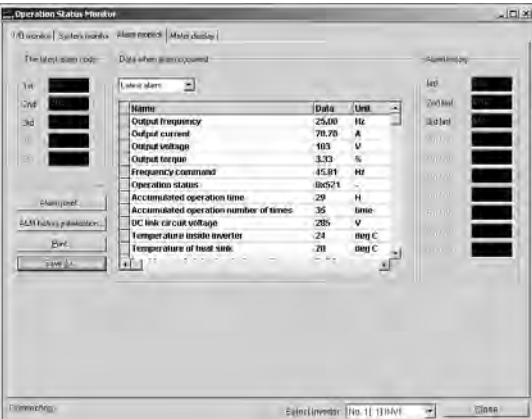

Meter display

Displays analog readouts of the selected inverter (such as output frequency) on analog meters. The example on the right displays the reference frequency and the output frequency.

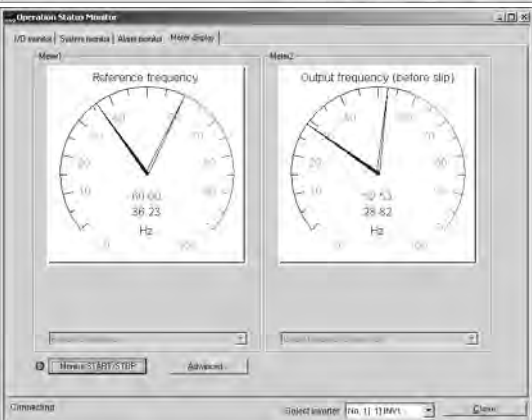

5.2.3.4 Test-running

The Test-running feature allows you to test-run the motor in "Run forward" or "Run reverse" while monitoring the running status of the selected inverter.

Select monitor item

Select what is to be displayed here from output frequency, current, etc.

Setting frequency command

Enter or select the set frequency command to write it into the inverter. Click **Apply** to make it effective.

I/O terminal status

Shows status of the programmable I/O terminals of the inverter.

Indicating Operation status

Shows FWD, REV, STOP and Alarm codes.

Operation buttons*

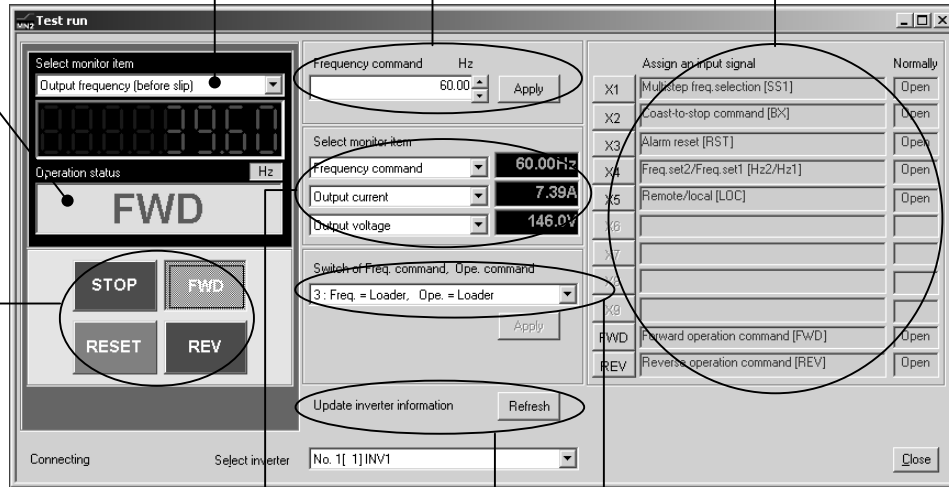

Selecting monitor item

Select the operation status information to be monitored real-time.

Update the inverter info for the latest ones

Click the **Refresh** button to update running status of the inverter shown on the Loader screen. Loader will become to show the latest inverter status.

Switching frequency and run command sources

Select the frequency and run command sources and apply them by clicking **Apply**.

* Refer to the table shown below for details of the operation buttons. The indented appearance of the **FWD** button as shown in the figure above indicates that it is active for running the motor forward, while that of the **REV** button is same for running reverse.

Button	Description
STOP	Stops the motor.
FWD	Run the motor forward.
REV	Run the motor reverse.
RESET	Resets all alarm information saved in the selected inverter.

5.2.3.5 Real-time trace—Displaying running status of an inverter in waveforms

This function allows you to monitor up to 4 analog readouts and up to 8 digital ON/OFF signals (maximum number of monitor item to be displayed is 8 channels), measured at fixed sampling intervals of 200 ms, which represent the running status of a selected inverter. These quantities are displayed in real-time waveforms on a time trace.

Waveform capturing capability: Max. 15,360 samples/channel

Sub-panes

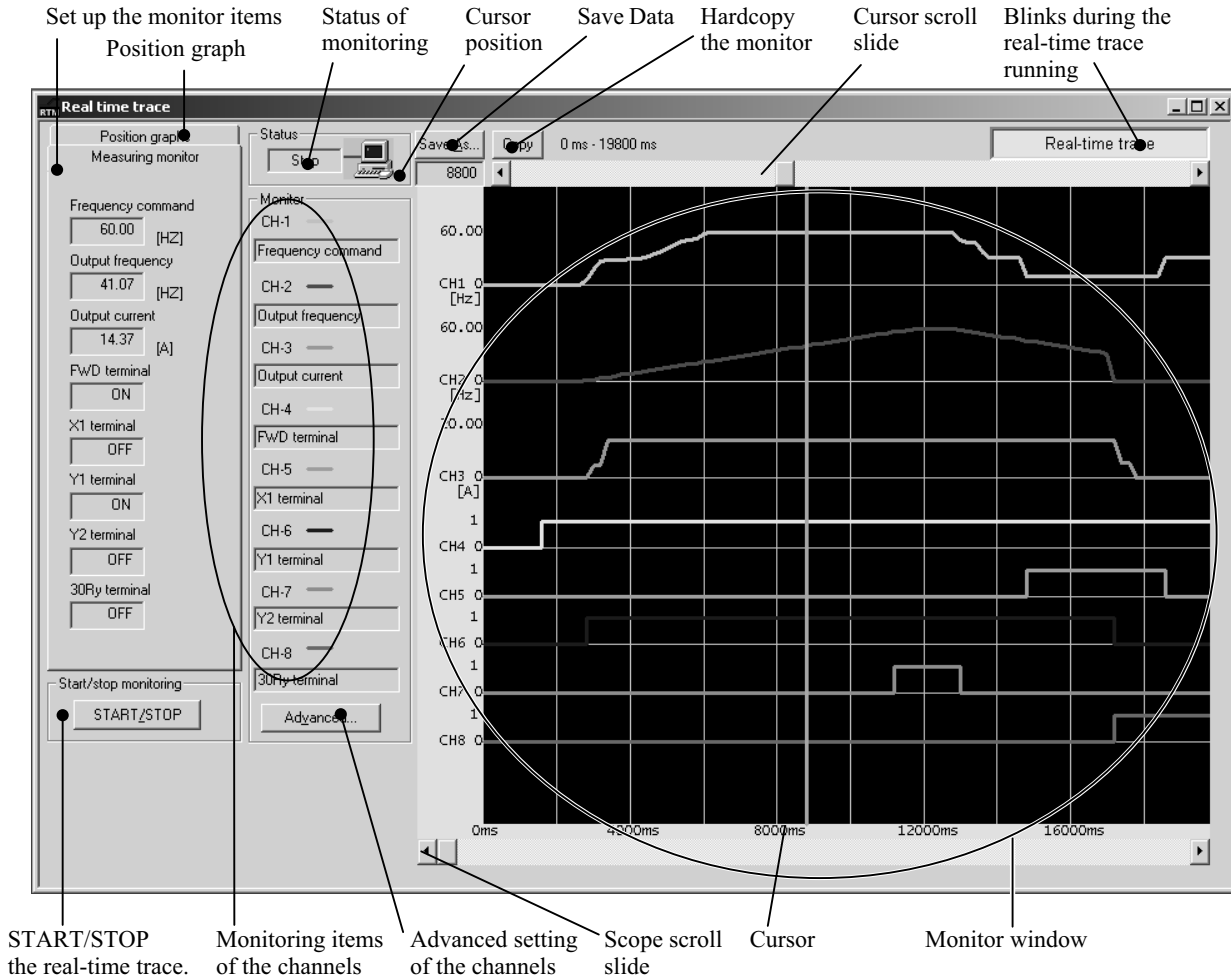

During the real-time trace in progress you cannot:

- Change the RS-485 station address,
- Change the advanced waveform settings, or
- Scroll the real-time trace screen or move the cursor.

Resizing the real-time trace window automatically changes the monitor window size.

Part 3 Peripheral Equipment and Options



Chapter 6 SELECTING PERIPHERAL EQUIPMENT

Chapter 6

SELECTING PERIPHERAL EQUIPMENT

This chapter describes how to use a range of peripheral equipment and options, FRENIC-Multi's configuration with them, and requirements and precautions for selecting wires and crimp terminals.

Contents

6.1	Configuring the FRENIC-Multi	6-1
6.2	Selecting Wires and Crimp Terminals.....	6-2
6.2.1	Recommended wires	6-4
6.3	Peripheral Equipment.....	6-8
[1]	Molded case circuit breaker (MCCB), ground-fault circuit interrupter (GFCI) and magnetic contactor (MC).....	6-8
[2]	Surge killers.....	6-12
[3]	Arresters	6-12
[4]	Surge absorbers	6-13
6.4	Selecting Options	6-14
6.4.1	Peripheral equipment options.....	6-14
[1]	Braking resistors.....	6-14
[2]	DC reactors (DCRs)	6-17
[3]	AC reactors (ACRs)	6-19
[4]	Output circuit filters (OFLs).....	6-20
[5]	Zero-phase reactor for reducing radio noise (ACL)	6-22
6.4.2	Options for operation and communications	6-23
[1]	External potentiometer for frequency setting	6-23
[2]	Multi-function keypad	6-24
[3]	Extension cable for remote operation.....	6-24
[4]	RS-485 communications card.....	6-25
[5]	Inverter support loader software.....	6-25
6.4.3	Meter options	6-26
[1]	Frequency meters.....	6-26

6.1 Configuring the FRENIC-Multi

This section lists the names and features of peripheral equipment and options for the FRENIC-Multi series of inverters and includes a configuration example for reference. Refer to Figure 6.1 for a quick overview of available options.

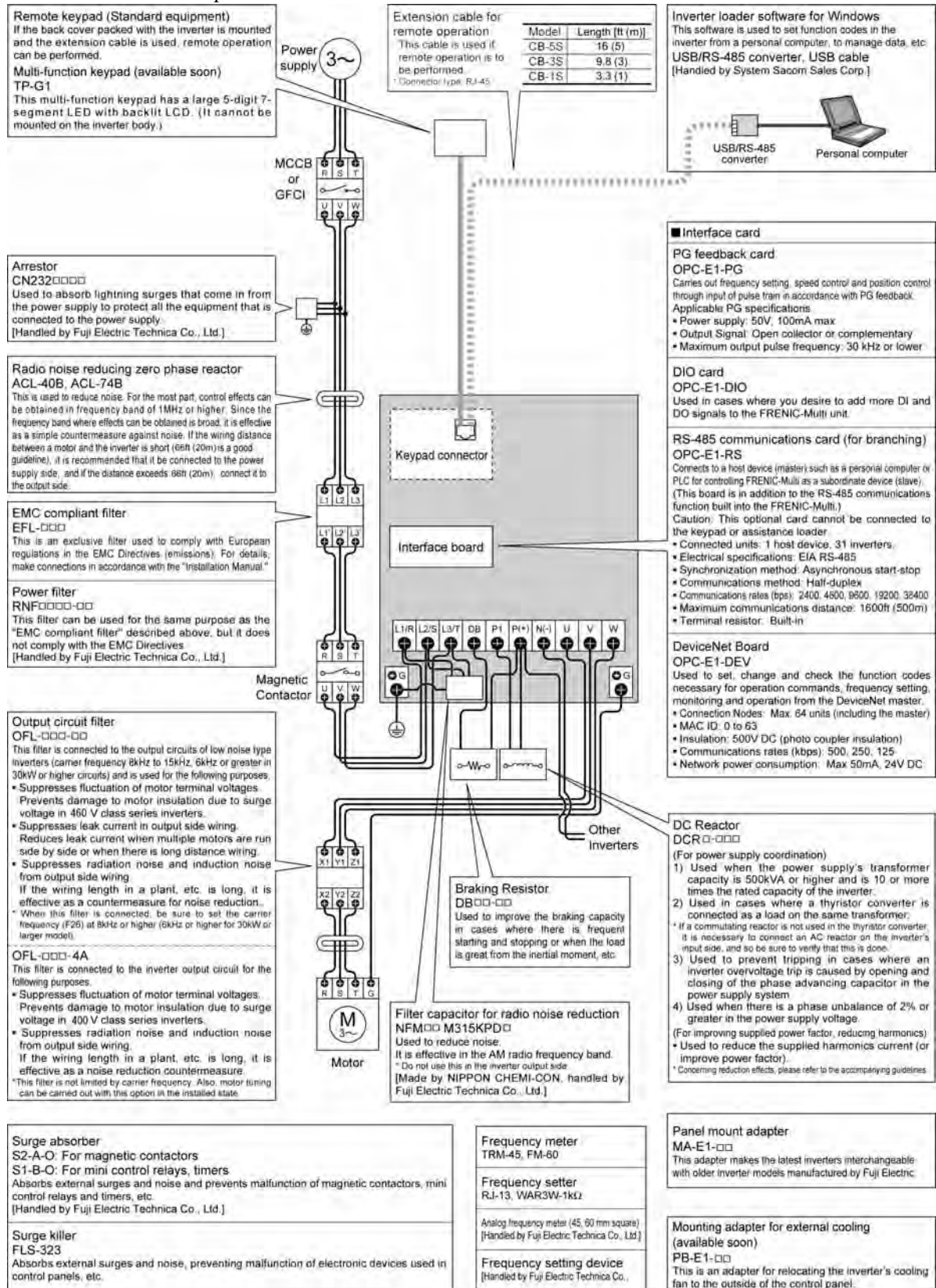

Figure 6.1 Quick Overview of Options

6.2 Selecting Wires and Crimp Terminals

This section contains information needed to select wires for connecting the inverter to commercial power lines, motor or any of the optional/peripheral equipment. The level of electric noise issued from the inverter or received by the inverter from external sources may vary depending upon wiring and routing. To solve such noise-related problems, refer to Appendix A "Advantageous Use of Inverters (Notes on electrical noise)."

Select wires that satisfy the following requirements:

- Sufficient capacity to flow the rated average current (allowable current capacity).
- Protective coordination with an MCCB or GFCI with overcurrent protection in the overcurrent zone.
- Voltage loss due to the wire length is within the allowable range.
- Suitable for the type and size of terminals of the optional equipment to be used.

Recommended wires are listed below. Use these wires unless otherwise specified.

■ 600 V class of vinyl-insulated wires (IV wires)

Use this class of wire for the power circuits. This class of wire is hard to twist, so using it for the control signal circuits is not recommended. Maximum ambient temperature for this wire is 60°C (140°F).

■ 600 V grade heat-resistant PVC insulated wires or 600 V polyethylene insulated wires (HIV wires)

As wires in this class are smaller in diameter and more flexible than IV wires and can be used at a higher ambient temperature (75°C (167°F)), they can be used for both of the main power and control signal circuits. To use this class of wire for the control circuits, you need to correctly twist the wires and keep the wiring length for equipment being connected as short as possible.

■ 600 V cross-linked polyethylene-insulated wires

Use this class of wire mainly for power and grounding circuits. These wires are smaller in diameter and more flexible than those of the IV and HIV classes of wires, meaning that these wires can be used to save on space and increase operation efficiency of your power system, even in high temperature environments. The maximum allowable ambient temperature for this class of wires is 90°C (194°F). The (Boardlex) wire range available from Furukawa Electric Co., Ltd. satisfies these requirements.

■ Shielded-Twisted cables for internal wiring of electronic/electric equipment

Use this category of cables for the control circuits of the inverter so as to prevent the signal lines from being affected by noise from external sources, including the power input/output lines of the inverter themselves. Even if the signal lines are inside the power control panel, always use this category of cables when the length of wiring is longer than normal. Cables satisfying these requirements are the Furukawa's BEAMEX S shielded cables of the XEBV and XEWW ranges.

Currents Flowing across the Inverter Terminals

Table 6.1 summarizes average (effective) electric currents flowing across the terminals of each inverter model for ease of reference when selecting peripheral equipment, options and electric wires for each inverter--including supplied power voltage and applicable motor rating.

Table 6.1 Currents Flowing through Inverter

Power supply voltage	Nominal applied motor (HP)	230 V/460 V, 50 Hz				220 V (230 V)/440 V (460 V), 60 Hz					
		Input RMS current (A)		DC link bus current (A)	Braking resistor circuit current (A)	Input RMS current (A)		DC link bus current (A)	Braking resistor circuit current (A)		
		DC reactor (DCR)				DC reactor (DCR)					
		w/ DCR	w/o DCR	w/ DCR	w/o DCR						
Three-phase 230V	1/8	0.57	1.1	0.7	0.82	0.51 (0.55)	1.1 (1.1)	0.62 (0.7)	0.82		
	1/4	0.93	1.8	1.1	1.2	0.85 (0.92)	1.7 (1.8)	1.0 (1.1)	1.2		
	1/2	1.6	3.1	2.0	1.2	1.5 (1.6)	3.0 (3.1)	1.8 (2.0)	1.2		
	1	3.0	5.3	3.7	1.6	2.8 (3.0)	5.0 (5.3)	3.4 (3.7)	1.6		
	2	5.7	9.5	7.0	3.6	5.2 (5.6)	9.0 (9.5)	6.3 (6.9)	3.6		
	3	8.3	13.2	10.2	3.5	7.6 (8.3)	12.3 (13.2)	9.3 (10.1)	3.5		
	5	14.0	22.2	17.2	4.1	12.7 (13.9)	20.6 (22.2)	15.6 (17.0)	4.1		
	7.5	21.1	31.5	25.9	6.4	19.0 (20.9)	28.4 (31.2)	23.3 (25.6)	6.4		
	10	28.8	42.7	35.3	6.1	26.0 (28.6)	38.5 (42.3)	31.9 (35.1)	6.1		
	15	42.2	60.7	51.7	9.1	38.0 (41.8)	54.7 (60.1)	46.6 (51.2)	9.1		
Three-phase 460V	1/2	0.85	1.7	1.0	0.8	0.74 (0.85)	1.7 (1.7)	0.99 (1.0)	0.8		
	1	1.6	3.1	1.8	1.1	1.4 (1.6)	3.0 (3.0)	1.7 (2.0)	1.1		
	2	3.0	5.9	3.5	1.8	2.6 (3.0)	5.1 (5.9)	3.2 (3.6)	1.8		
	3	4.4	8.2	5.1	1.8	3.8 (4.3)	7.1 (8.2)	4.6 (5.3)	1.8		
	5	7.3	13.0	8.6	2.1	6.4 (7.3)	11.1 (12.9)	7.8 (8.9)	2.1		
	7.5	10.6	17.3	13.0	3.2	9.6 (10.5)	15.7 (17.2)	12.9 (11.8)	3.2		
	10	14.4	23.2	17.7	3.1	13.0 (14.3)	21.0 (23.0)	17.6 (16.0)	3.1		
	15	21.1	33.0	25.9	4.5	19.0 (20.9)	29.8 (32.7)	25.6 (23.3)	4.5		
Single-phase 230V	1/8	1.1	1.8	1.1	0.61	1.0 (1.1)	1.8 (1.8)	1.0 (1.1)	0.61		
	1/4	2.0	3.3	2.0	0.66	1.8 (1.9)	3.1 (3.3)	1.8 (1.9)	0.66		
	1/2	3.5	5.4	3.5	0.82	3.1 (3.4)	5.0 (5.4)	3.1 (3.4)	0.82		
	1	6.4	9.7	6.4	1.4	5.8 (6.3)	9.1 (9.7)	5.8 (6.3)	1.4		
	2	11.6	16.4	12	1.4	10.5 (11.3)	15.5 (16.4)	10.5 (11.3)	1.4		
	3	17.5	24.8	18	1.7	15.8 (17.0)	23.4 (24.8)	15.8 (17.0)	1.7		

- Inverter efficiency is calculated using values suitable for each inverter model. The input route mean square (RMS) current is calculated according to the following conditions:
Power supply capacity: 500 kVA; power supply impedance: 5%
- The current listed in the above table will vary in inverse proportion to the power supply voltage, such as 230 VAC and 380 VAC.
- The braking current is always constant, independent of braking resistor specifications, including built-in, standard and 10%ED models.

6.2.1 Recommended wires

Tables 6.2 and 6.3 list the recommended wires according to the internal temperature of your power control panel.

- If the internal temperature of your power control panel is 50°C (122°F) or below

Table 6.2 Wire Size (for main circuit power input and inverter output)

Power supply voltage	Nominal applied motor (HP)	Inverter type	Recommended wire size (mm ²)											
			Main circuit power input [L1/R , L2/S , L3/T] or [L1/L, L2/N]							Inverter output [U , V , W]				
			w/ DC reactor (DCR)				w/o DC reactor (DCR)							
			Allowable temp.*1			Current (A)	Allowable temp.*1			Current (A)	Allowable temp.*1			Current (A)
60°C (140°F)	75°C (167°F)	90°C (194°F)	60°C (140°F)	75°C (167°F)	90°C (194°F)		60°C (140°F)	75°C (167°F)	90°C (194°F)					
Three-phase 230V	1/8	FRNF12E1S-2U	2.0	2.0	2.0	0.57	2.0	2.0	2.0	1.1	2.0	2.0	2.0	0.8
	1/4	FRNF25E1S-2U	2.0	2.0	2.0	0.93	2.0	2.0	2.0	1.8	2.0	2.0	2.0	1.5
	1/2	FRNF50E1S-2U	2.0	2.0	2.0	1.6	2.0	2.0	2.0	3.1	2.0	2.0	2.0	3.0
	1	FRN001E1S-2U	2.0	2.0	2.0	3.0	2.0	2.0	2.0	5.3	2.0	2.0	2.0	5.0
	2	FRN002E1S-2U	2.0	2.0	2.0	5.7	2.0	2.0	2.0	9.5	2.0	2.0	2.0	8.0
	3	FRN003E1S-2U	2.0	2.0	2.0	8.3	2.0	2.0	2.0	13.2	2.0	2.0	2.0	11
	5	FRN005E1S-2U	2.0	2.0	2.0	14.0	5.5	2.0	2.0	22.2	3.5	2.0	2.0	17
	7.5	FRN007E1S-2U	5.5	2.0	2.0	21.1	8.0	3.5	3.5	31.5	5.5	3.5	2.0	25
	10	FRN010E1S-2U	8.0	3.5	2.0	28.8	14.0	5.5	5.5	42.7	8.0	3.5	3.5	33
	15	FRN015E1S-2U	14.0	5.5	5.5	42.2	22.0	14.0	8.0	60.7	14.0	8.0	5.5	47
	20	FRN020E1S-2U	22.0	14.0	8.0	57.6	38.0	22.0	14.0	80.1	22.0	14.0	8.0	60
Three-phase 460V	1/2	FRNF50E1S-4U	2.0	2.0	2.0	0.85	2.0	2.0	2.0	1.7	2.0	2.0	2.0	1.5
	1	FRN001E1S-4U	2.0	2.0	2.0	1.6	2.0	2.0	2.0	3.1	2.0	2.0	2.0	2.5
	2	FRN002E1S-4U	2.0	2.0	2.0	3.0	2.0	2.0	2.0	5.9	2.0	2.0	2.0	3.7
	3	FRN003E1S-4U	2.0	2.0	2.0	4.4	2.0	2.0	2.0	8.2	2.0	2.0	2.0	5.5
	5	FRN005E1S-4U	2.0	2.0	2.0	7.3	2.0	2.0	2.0	13.0	2.0	2.0	2.0	9.0
	7.5	FRN007E1S-4U	2.0	2.0	2.0	10.6	3.5	2.0	2.0	17.3	2.0	2.0	2.0	13
	10	FRN010E1S-4U	2.0	2.0	2.0	14.4	5.5	2.0	2.0	23.2	3.5	2.0	2.0	18
	15	FRN015E1S-4U	5.5	2.0	2.0	21.1	8.0	3.5	3.5	33.0	5.5	2.0	2.0	24
	20	FRN020E1S-4U	8.0	3.5	2.0	28.8	14.0	5.5	5.5	43.8	8.0	3.5	2.0	30
Single-phase 230V	1/8	FRNF12E1S-7U	2.0	2.0	2.0	1.1	2.0	2.0	2.0	1.8	2.0	2.0	2.0	0.8
	1/4	FRNF25E1S-7U	2.0	2.0	2.0	2.0	2.0	2.0	2.0	3.3	2.0	2.0	2.0	1.5
	1/2	FRNF50E1S-7U	2.0	2.0	2.0	3.5	2.0	2.0	2.0	5.4	2.0	2.0	2.0	3.0
	1	FRN001E1S-7U	2.0	2.0	2.0	6.4	2.0	2.0	2.0	9.7	2.0	2.0	2.0	5.0
	2	FRN002E1S-7U	2.0	2.0	2.0	11.6	3.5	2.0	2.0	16.4	2.0	2.0	2.0	8.0
	3	FRN003E1S-7U	3.5	2.0	2.0	17.5	5.5	3.5	2.0	24.8	2.0	2.0	2.0	11

- *1 Assuming the use of aerial wiring (without rack or duct): 600 V class of vinyl-insulated IV wires for 60°C (140°F), 600 V class of polyethylene-insulated HIV wires for 75°C (167°F), and 600 V cross-linked polyethylene insulated wires for 90°C (194°F).

Table 6.2 Cont. (for DC reactor, braking resistor, control circuits, and inverter grounding)

Power supply voltage	Nominal applied motor (HP)	Inverter type	Recommended wire size (mm ²)													
			DC reactor [P1, P(+)]				Braking resistor [P(+), DB]				Control circuit			Inverter grounding [G]		
			Allowable temp.*1			Current (A)	Allowable temp.*1			Current (A)	Allowable temp.*1			Allowable temp.*1		
			60°C (140°F)	75°C (167°F)	90°C (194°F)		60°C (140°F)	75°C (167°F)	90°C (194°F)		60°C (140°F)	75°C (167°F)	90°C (194°F)	60°C (140°F)	75°C (167°F)	90°C (194°F)
Three-phase 230V	1/8	FRNF12E1S-2U	2.0	2.0	2.0	0.7	2.0	2.0	2.0	0.82	0.75 to 1.25	0.75 to 1.25	0.75 to 1.25	2.0		
	1/4	FRNF25E1S-2U	2.0	2.0	2.0	1.1	2.0	2.0	2.0	1.2						
	1/2	FRNF50E1S-2U	2.0	2.0	2.0	2.0	2.0	2.0	2.0	1.2						
	1	FRN001E1S-2U	2.0	2.0	2.0	3.7	2.0	2.0	2.0	1.6						
	2	FRN002E1S-2U	2.0	2.0	2.0	7.0	2.0	2.0	2.0	3.6						
	3	FRN003E1S-2U	2.0	2.0	2.0	10.2	2.0	2.0	2.0	3.5						
	5	FRN005E1S-2U	3.5	2.0	2.0	17.2	2.0	2.0	2.0	4.1						
	7.5	FRN007E1S-2U	5.5	3.5	2.0	25.9	2.0	2.0	2.0	6.4						
	10	FRN010E1S-2U	14.0	5.5	3.5	35.3	2.0	2.0	2.0	6.1						
Three-phase 460V	1/2	FRNF50E1S-4U	2.0	2.0	2.0	1.0	2.0	2.0	2.0	0.8	0.75 to 1.25	0.75 to 1.25	0.75 to 1.25	2.0		
	1	FRN001E1S-4U	2.0	2.0	2.0	2.0	2.0	2.0	1.1							
	2	FRN002E1S-4U	2.0	2.0	2.0	3.6	2.0	2.0	2.0	1.8						
	3	FRN003E1S-4U	2.0	2.0	2.0	5.3	2.0	2.0	2.0	1.8						
	5	FRN005E1S-4U	2.0	2.0	2.0	8.9	2.0	2.0	2.0	2.1						
	7.5	FRN007E1S-4U	2.0	2.0	2.0	13.0	2.0	2.0	2.0	3.2						
	10	FRN010E1S-4U	3.5	2.0	2.0	17.7	2.0	2.0	2.0	3.1						
Single-phase 230V	1/8	FRNF12E1S-7U	2.0	2.0	2.0	1.1	2.0	2.0	2.0	0.61	0.75 to 1.25	0.75 to 1.25	0.75 to 1.25	2.0		
	1/4	FRNF25E1S-7U	2.0	2.0	2.0	2.0	2.0	2.0	0.66							
	1/2	FRNF50E1S-7U	2.0	2.0	2.0	3.5	2.0	2.0	2.0	0.82						
Single-phase 230V	1	FRN001E1S-7U	2.0	2.0	2.0	6.4	2.0	2.0	2.0	1.4	0.75 to 1.25	0.75 to 1.25	0.75 to 1.25	2.0		
	2	FRN002E1S-7U	2.0	2.0	2.0	12	2.0	2.0	2.0	1.4						
	3	FRN003E1S-7U	3.5	2.0	2.0	18	2.0	2.0	2.0	1.7						

*1 Assuming the use of aerial wiring (without rack or duct): 600 V class of vinyl-insulated IV wires for 60°C (140°F), 600 V class of polyethylene-insulated HIV wires for 75°C (167°F), and 600 V cross-linked polyethylene insulated wires for 90°C (194°F).

 If environmental requirements such as power supply voltage and ambient temperature differ from those listed above, select wires suitable for your system by referring to Table 6.1 and Appendices, App. F "Allowable Current of Insulated Wires."

- If the internal temperature of your power control panel is 40°C (104°F) or below

Table 6.3 Wire Size (for main circuit power input and inverter output)

Power supply voltage	Nominal applied motor (HP)	Inverter type	Recommended wire size (mm ²)											
			Main circuit power input [L1/R, L2/S, L3/T] or [L1/L, L2/N]							Inverter output [U, V, W]				
			w/ DC reactor (DCR)			w/o DC reactor (DCR)								
			Allowable temp.*1			Current (A)	Allowable temp.*1			Current (A)	Allowable temp.*1			Current (A)
60°C (140°F)	75°C (167°F)	90°C (194°F)	60°C (140°F)	75°C (167°F)	90°C (194°F)		60°C (140°F)	75°C (167°F)	90°C (194°F)					
Three-phase 230V	1/8	FRNF12E1S-2U	2.0	2.0	2.0	0.57	2.0	2.0	2.0	1.1	2.0	2.0	2.0	0.8
	1/4	FRNF25E1S-2U	2.0	2.0	2.0	0.93	2.0	2.0	2.0	1.8	2.0	2.0	2.0	1.5
	1/2	FRNF50E1S-2U	2.0	2.0	2.0	1.6	2.0	2.0	2.0	3.1	2.0	2.0	2.0	3.0
	1	FRN001E1S-2U	2.0	2.0	2.0	3.0	2.0	2.0	2.0	5.3	2.0	2.0	2.0	5.0
	2	FRN002E1S-2U	2.0	2.0	2.0	5.7	2.0	2.0	2.0	9.5	2.0	2.0	2.0	8.0
	3	FRN003E1S-2U	2.0	2.0	2.0	8.3	2.0	2.0	2.0	13.2	2.0	2.0	2.0	11
	5	FRN005E1S-2U	2.0	2.0	2.0	14.0	3.5	2.0	2.0	22.2	2.0	2.0	2.0	17
	7.5	FRN007E1S-2U	2.0	2.0	2.0	21.1	5.5	3.5	2.0	31.5	3.5	2.0	2.0	25
	10	FRN010E1S-2U	3.5	2.0	2.0	28.8	8.0	5.5	3.5	42.7	5.5	3.5	2.0	33
Three-phase 460V	1/2	FRNF50E1S-4U	2.0	2.0	2.0	0.85	2.0	2.0	2.0	1.7	2.0	2.0	2.0	1.5
	1	FRN001E1S-4U	2.0	2.0	2.0	1.6	2.0	2.0	2.0	3.1	2.0	2.0	2.0	2.5
	2	FRN002E1S-4U	2.0	2.0	2.0	3.0	2.0	2.0	2.0	5.9	2.0	2.0	2.0	3.7
	3	FRN003E1S-4U	2.0	2.0	2.0	4.4	2.0	2.0	2.0	8.2	2.0	2.0	2.0	5.5
	5	FRN005E1S-4U	2.0	2.0	2.0	7.3	2.0	2.0	2.0	13.0	2.0	2.0	2.0	9.0
	7.5	FRN007E1S-4U	2.0	2.0	2.0	10.6	2.0	2.0	2.0	17.3	2.0	2.0	2.0	13
	10	FRN010E1S-4U	2.0	2.0	2.0	14.4	3.5	2.0	2.0	23.2	2.0	2.0	2.0	18
	15	FRN015E1S-4U	2.0	2.0	2.0	21.1	5.5	3.5	2.0	33.0	3.5	2.0	2.0	24
	20	FRN020E1S-4U	3.5	2.0	2.0	28.8	8.0	5.5	3.5	43.8	3.5	3.5	2.0	30
Single-phase 230V	1/8	FRNF12E1S-7U	2.0	2.0	2.0	1.1	2.0	2.0	2.0	1.8	2.0	2.0	2.0	0.8
	1/4	FRNF25E1S-7U	2.0	2.0	2.0	2.0	2.0	2.0	2.0	3.3	2.0	2.0	2.0	1.5
	1/2	FRNF50E1S-7U	2.0	2.0	2.0	3.5	2.0	2.0	2.0	5.4	2.0	2.0	2.0	3.0
	1	FRN001E1S-7U	2.0	2.0	2.0	6.4	2.0	2.0	2.0	9.7	2.0	2.0	2.0	5.0
	2	FRN002E1S-7U	2.0	2.0	2.0	11.6	2.0	2.0	2.0	16.4	2.0	2.0	2.0	8.0
3	FRN003E1S-7U	2.0	2.0	2.0	17.5	3.5	2.0	2.0	24.8	2.0	2.0	2.0	11	

*1 Assuming the use of aerial wiring (without rack or duct): 600 V class of vinyl-insulated IV wires for 60°C (140°F), 600 V class of polyethylene-insulated HIV wires for 75°C (167°F), and 600 V cross-linked polyethylene insulated wires for 90°C (194°F).

- If the internal temperature of your power control panel is 40°C (104°F) or below

Table 6.3 Cont. (for DC reactor, braking resistor, control circuit, and inverter grounding)

Power supply voltage	Nominal applied motor (HP)	Inverter type	Recommended wire size (mm ²)												
			DC reactor [P1, P(+)]				Braking resistor [P(+), DB]				Control circuit			Inverter grounding [G]	
			Allowable temp.*1			Current (A)	Allowable temp.*1			Current (A)	Allowable temp.*1			Allowable temp.*1	
			60°C (140°F)	75°C (167°F)	90°C (194°F)		60°C (140°F)	75°C (167°F)	90°C (194°F)		60°C (140°F)	75°C (167°F)	90°C (194°F)	60°C (140°F)	75°C (167°F)
Three-phase 230V	1/8	FRNF12E1S-2U	2.0	2.0	2.0	0.7	2.0	2.0	2.0	0.82	0.75 to 1.25	0.75 to 1.25	0.75 to 1.25	2.0	
	1/4	FRNF25E1S-2U	2.0	2.0	2.0	1.1	2.0	2.0	2.0	1.2					
	1/2	FRNF50E1S-2U	2.0	2.0	2.0	2.0	2.0	2.0	2.0	1.2					
	1	FRN001E1S-2U	2.0	2.0	2.0	3.7	2.0	2.0	2.0	1.6					
	2	FRN002E1S-2U	2.0	2.0	2.0	7.0	2.0	2.0	2.0	3.6					
	3	FRN003E1S-2U	2.0	2.0	2.0	10.2	2.0	2.0	2.0	3.5					
	5	FRN005E1S-2U	2.0	2.0	2.0	17.2	2.0	2.0	2.0	4.1					
	7.5	FRN007E1S-2U	3.5	2.0	2.0	25.9	2.0	2.0	2.0	6.4					
	10	FRN010E1S-2U	5.5	3.5	3.5	35.3	2.0	2.0	2.0	6.1					
Three-phase 460V	1/2	FRNF50E1S-4U	2.0	2.0	2.0	1.0	2.0	2.0	2.0	0.8	0.75 to 1.25	0.75 to 1.25	0.75 to 1.25	2.0	
	1	FRN001E1S-4U	2.0	2.0	2.0	2.0	2.0	2.0	2.0	1.1					
	2	FRN002E1S-4U	2.0	2.0	2.0	3.6	2.0	2.0	2.0	1.8					
	3	FRN003E1S-4U	2.0	2.0	2.0	5.3	2.0	2.0	2.0	1.8					
	5	FRN005E1S-4U	2.0	2.0	2.0	8.9	2.0	2.0	2.0	2.1					
	7.5	FRN007E1S-4U	2.0	2.0	2.0	13.0	2.0	2.0	2.0	3.2					
	10	FRN010E1S-4U	2.0	2.0	2.0	17.7	2.0	2.0	2.0	3.1					
	15	FRN015E1S-4U	3.5	2.0	2.0	25.9	2.0	2.0	2.0	4.5					
	20	FRN020E1S-4U	5.5	3.5	3.5	35.3	2.0	2.0	2.0	5.7					
Single-phase 230V	1/8	FRNF12E1S-7U	2.0	2.0	2.0	1.1	2.0	2.0	2.0	0.61	0.75 to 1.25	0.75 to 1.25	0.75 to 1.25	2.0	
	1/4	FRNF25E1S-7U	2.0	2.0	2.0	2.0	2.0	2.0	0.66						
	1/2	FRNF50E1S-7U	2.0	2.0	2.0	3.5	2.0	2.0	2.0	0.82					
	1	FRN001E1S-7U	2.0	2.0	2.0	6.4	2.0	2.0	2.0	1.4					
	2	FRN002E1S-7U	2.0	2.0	2.0	12	2.0	2.0	2.0	1.4					

*1 Assuming the use of aerial wiring (without rack or duct): 600 V class of vinyl-insulated IV wires for 60°C (140°F), 600 V class of polyethylene-insulated HIV wires for 75°C (167°F), and 600 V cross-linked polyethylene insulated wires for 90°C (194°F).

 If environmental requirements such as power supply voltage and ambient temperature differ from those listed above, select wires suitable for your system by referring to Table 6.1 and Appendices, App. F "Allowable Current of Insulated Wires."

6.3 Peripheral Equipment

[1] Molded case circuit breaker (MCCB), ground-fault circuit interrupter (GFCI) and magnetic contactor (MC)

[1.1] Functional overview

■ MCCBs and GFCIs*

*With overcurrent protection

Molded Case Circuit Breakers (MCCBs) are designed to protect the power circuits between the power supply and inverter's main circuit terminals ([L1/R], [L2/S] and [L3/T] for three phase, or [L1/L] and [L2/N] for single-phase power supply) from overload or short-circuit, which in turn prevents secondary accidents caused by the broken inverter.

Ground-Fault Circuit Interrupters (GFCIs) function in the same way as MCCBs.

Built-in overcurrent/overload protective functions protect the inverter itself from failures related to its input/output lines.

■ MCs

An MC can be used at both the power input and output sides of the inverter. At each side, the MC works as described below. When inserted in the output circuit of the inverter, the MC can also switch the motor drive power supply between the inverter output and commercial power lines.

At the power supply side

Insert an MC in the power supply side of the inverter in order to:

- (1) Forcibly cut off the inverter from the power supply (generally, commercial/factory power lines) with the protective function built into the inverter, or with the external signal input.
- (2) Stop the inverter operation in an emergency when the inverter cannot interpret the stop command due to internal/external circuit failures.
- (3) Cut off the inverter from the power supply when the MCCB inserted in the power supply side cannot cut it off for maintenance or inspection purpose. For the purpose only, it is recommended that you use an MC capable of turning the MC ON/OFF manually.



When your system requires starting/stopping the motor(s) driven by the inverter with the MC, the frequency of the starting/stopping operation should be once or less per hour. The more frequent the operation, the shorter operation life of the MC and capacitor/s used in the DC link bus due to thermal fatigue caused by the frequent charging of the current flow. It is recommended that terminal commands **FWD**, **REV** and **HLD** for 3-wire operation or the keypad be used for starting/stopping the motor.

At the output side

Insert an MC in the power output side of the inverter in order to:

- (1) Prevent externally turned-around current from being applied to the inverter power output terminals ([U], [V], and [W]) unexpectedly. An MC should be used, for example, when a circuit that switches the motor driving power supply between the inverter output and commercial power lines is connected to the inverter.



As application of the external current to the inverter's secondary (output) circuits may break the Insulated Gate Bipolar Transistors (IGBTs), MCs should be used in the power control system circuits to switch the motor drive power supply to the commercial power lines after the motor has come to a complete stop. Also ensure that voltage is never mistakenly applied to the inverter output terminals due to unexpected timer operation, or similar.

- (2) Drive more than one motor selectively by a single inverter.
- (3) Selectively cut off the motor whose thermal overload relay or equivalent devices have been activated.

Driving the motor using commercial power lines

MCs can also be used to switch the power supply of the motor driven by the inverter to a commercial power supply.

Select the MC so as to satisfy the rated currents listed in Table 6.1, which are the most critical RMS currents for using the inverter. (Refer to Table 6.4) For switching the motor drive source between the inverter output and commercial power lines, use the MC of class AC3 specified by JIS C8325 in the commercial line side.

[1.2] Connection example and criteria for selection of circuit breakers

Figure 6.2 shows a connection example for MCCB or GFCI (with overcurrent protection) in the inverter input circuit. Table 6.4 lists the rated current for the MCCB and corresponding inverter models. Table 6.5 lists the applicable grades of GFCI sensitivity.

⚠ WARNING
Insert an MCCB or GFCI (with overcurrent protection) recommended for each inverter for its input circuits. Do not use an MCCB or GFCI of a higher rating than that recommended.
Doing so could result in a fire.

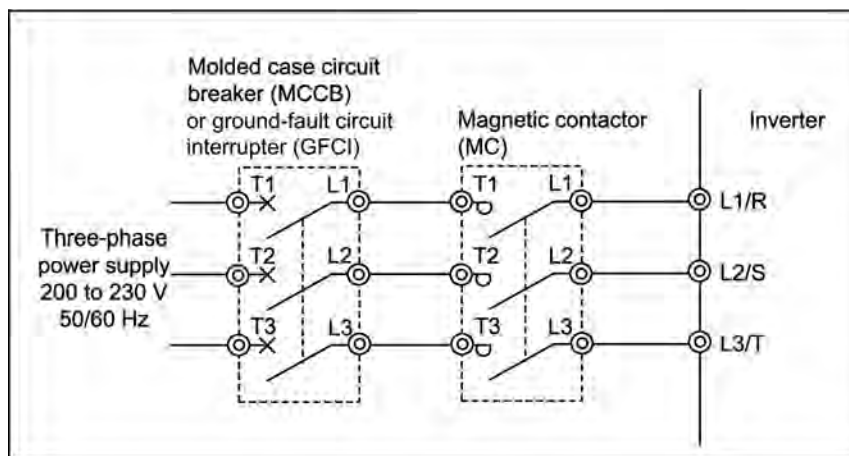
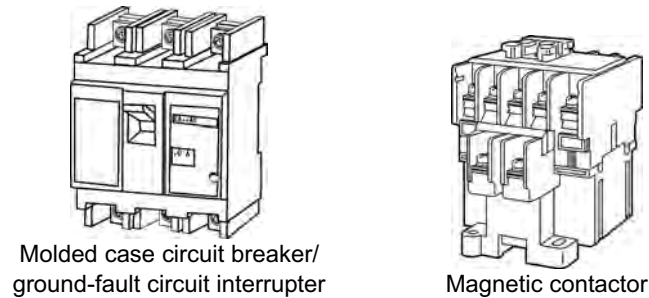

Figure 6.2 External Views of Molded Case Circuit Breaker/Ground-Fault Circuit Interrupter, Magnetic Contactor and Connection Example

Table 6.4 Rated Current of Molded Case Circuit Breaker/ Ground-Fault Circuit Interrupter and Magnetic Contactor

Power supply voltage	Nominal applied motor (HP)	Inverter type	MCCB, GFCI Rated current (A)		Magnetic contactor type MC1 (for input circuit)		Magnetic contactor type MC2 (for output circuit)
			DC reactor (DCR)		DC reactor (DCR)		
			w/ DCR	w/o DCR	w/ DCR	w/o DCR	
Three-phase 230V	1/8	FRNF12E1S-2U	5	5	SC-05	SC-05	SC-05
	1/4	FRNF25E1S-2U		5			
	1/2	FRNF50E1S-2U		10			
	1	FRN001E1S-2U		15			
	2	FRN002E1S-2U	10	20	SC-4-0	SC-5-1	SC-4-0
	3	FRN003E1S-2U		30			
	5	FRN005E1S-2U	30	50	SC-4-0	SC-5-1	SC-4-0
	7.5	FRN007E1S-2U	40	75	SC-5-1	SC-N1	SC-5-1
	10	FRN010E1S-2U	50	100	SC-N1	SC-N2S	SC-N1
	15	FRN015E1S-2U	75	125	SC-N2	SC-N3	SC-N2
Three-phase 460V	1/2	FRNF50E1S-4U	5	5	SC-05	SC-05	SC-05
	1	FRN001E1S-4U		10			
	2	FRN002E1S-4U		15			
	3	FRN003E1S-4U		20			
	5	FRN005E1S-4U	10	20	SC-4-0	SC-N1	SC-4-0
	7.5	FRN007E1S-4U	15	30			
	10	FRN010E1S-4U	20	40	SC-4-0	SC-N1	SC-5-1
	15	FRN015E1S-4U	30	50			
20	FRN020E1S-4U	40	60	SC-5-1			
Single-phase 230V	1/8	FRNF12E1S-7U	5	5	SC-05	SC-05	SC-05
	1/4	FRNF25E1S-7U		10			
	1/2	FRNF50E1S-7U		15			
	1	FRN001E1S-7U	10	15	SC-5-1		
	2	FRN002E1S-7U	15	20			
	3	FRN003E1S-7U	20	30			

- The above table lists the rated current of MCCBs and GFCIs to be used in the power control panel with an internal temperature of lower than 50°C (122°F). The rated current is factored by a correction coefficient of 0.85 as the MCCBs' and GFCIs' original rated current is specified when using them in an ambient temperature of 40°C (104°F) or lower. Select an MCCB and/or GFCI suitable for the actual short-circuit breaking capacity needed for your power systems.
- For the selection of the MC type, it is assumed that the **600 V HIV (allowable ambient temperature: 75°C (167°F))** wires for the power input/output of the inverter are used. If an MC type for another class of wires is selected, the wire size suitable for the terminal size of both the inverter and the MC type should be taken into account.
- Use GFCIs with overcurrent protection.
- To protect your power systems from secondary accidents caused by the broken inverter, use an MCCB and/or GFCI with the rated current listed in the above table. Do not use an MCCB or GFCI with a rating higher than that listed.

Table 6.5 lists the relationship between the rated leakage current sensitivity of GFCIs (with overcurrent protection) and wiring length of the inverter output circuits. Note that the sensitivity levels listed in the table are estimated values based on the results obtained by the test setup in the Fuji laboratory where each inverter drives a single motor.

Table 6.5 Rated Current Sensitivity of Ground-Fault Circuit Interrupter (GFCI)

Power supply voltage	Nominal applied motor (HP)	Wiring length and current sensitivity					
		33 ft (10 m)	98 ft (30 m)	164 ft (50 m)	328 ft (100 m)	656 ft (200 m)	984 ft (300 m)
Three-phase 230 V	1/8						
	1/4						
	1/2						
	1						
	2		30 mA		100 mA		200 mA
	3						
	5						
	7.5						
	10						
	20						
Three-phase 460 V	1/2						
	1						
	2						
	3	30 mA		100 mA		200 mA	500 mA
	5						
	7.5						
	10						
	20						
Single-phase 230 V	1/8						
	1/4						
	1/2		30 mA		100 mA		200 mA
	1						
	3						

- Values listed above were obtained using Fuji GFCI EG or SG series applied to the test setup.
- The rated current of applicable motor rating indicates values for Fuji standard motor (4 poles, 50 Hz and 230 V three-phase).
- The leakage current is calculated based on grounding of the single wire for 230 V class Δ -connection and the neutral-point grounding for 460 V class Y-connection power lines.
- Values listed above are calculated based on the static capacitance to the earth when the 600 V class of vinyl-insulated IV wires are used in a wiring through metal conduit pipes.
- Wiring length is the total length of wiring between the inverter and motor. If more than one motor is to be connected to a single inverter, the wiring length should be the total length of wiring between the inverter and motors.

[2] Surge killers

A surge killer eliminates surge currents induced by lightning and noise from the power supply lines. Use of a surge killer is effective in preventing the electronic equipment, including inverters, from damage or malfunctioning caused by such surges and/or noise.

The applicable model of surge killer is the FSL-323. Figure 6.3 shows its external dimensions and a connection example. Refer to the catalog "Fuji Noise Suppressors (SH310: Japanese edition only)" for details. These products are available from Fuji Electric Technica Co., Ltd.

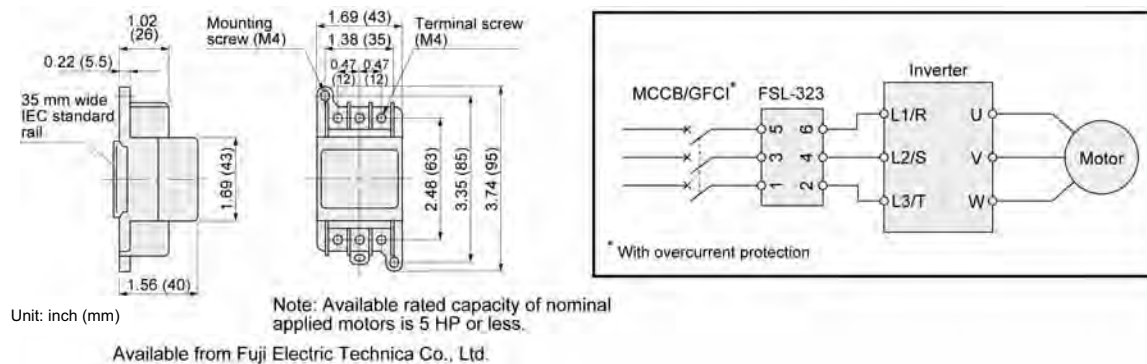

Figure 6.3 Dimensions of Surge Killer and Connection Example

[3] Arresters

An arrester suppresses surge currents and noise invaded from the power supply lines. Use of an arrester is effective in preventing electronic equipment, including inverters, from damage or malfunctioning caused by such surges and/or noise.

Applicable arrester models are the CN23232 and CN2324E. Figure 6.4 shows their external dimensions and connection examples. Refer to the catalog "Fuji Noise Suppressors (SH310: Japanese edition only)" for details. These products are available from Fuji Electric Technica Co., Ltd.

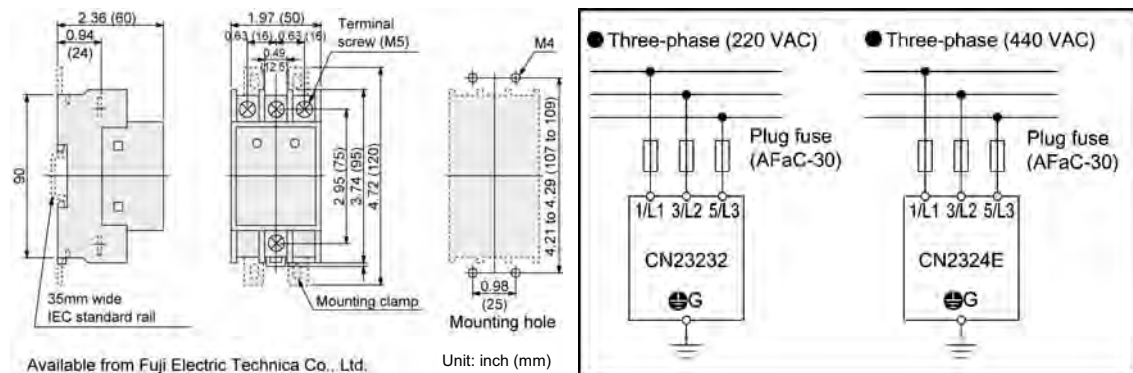

Figure 6.4 Arrester Dimensions and Connection Examples

[4] Surge absorbers

A surge absorber suppresses surge currents and noise from the power lines to ensure effective protection of your power system from the malfunctioning of the magnetic contactors, miniature control relays and timers.

Applicable surge absorber models are the S2-A-O and S1-B-O. Figure 6.5 shows their external dimensions. Refer to the catalog "Fuji Noise Suppressors (SH310: Japanese edition only)" for details. The surge absorbers are available from Fuji Electric Technica Co., Ltd.

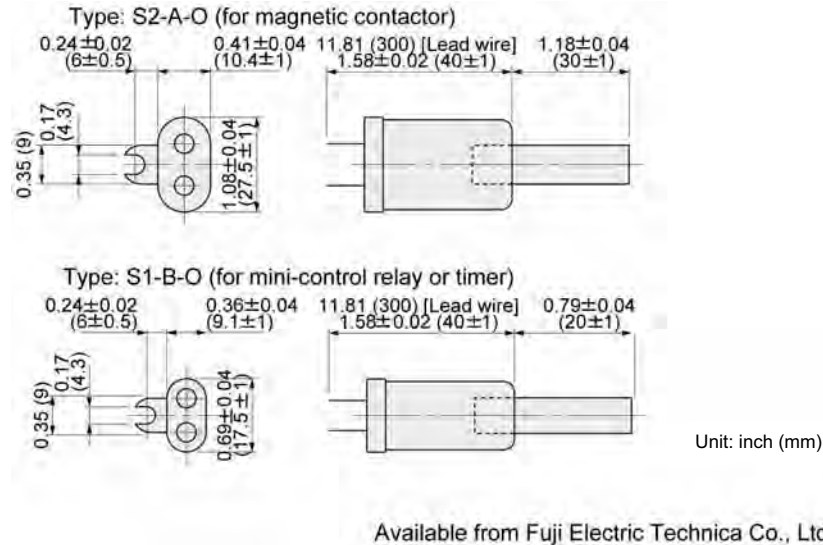



Figure 6.5 Surge Absorber Dimensions

6.4 Selecting Options

6.4.1 Peripheral equipment options

[1] Braking resistors

A braking resistor converts regenerative energy generated from deceleration of the motor to heat for consumption. Use of a braking resistor results in improved deceleration performance of the inverter.

 Refer to Chapter 7, Section 7.2 "Selecting a Braking Resistor."

[1.1] Standard model

The standard model of a braking resistor integrates a facility that detects the temperature on the heat sink of the resistor and outputs a digital ON/OFF signal if the temperature exceeds the specified level (as an overheating warning signal). To ensure that the signal is recognized at one of the digital input terminals of the FRENIC-Multi, assign the external alarm **THR** to any of terminals [X1] to [X5], [FWD] and [REV]. Connect the assigned terminals to terminals [1] and [2] of the braking resistor. Upon detection of the warning signal (preset detection level: 150°C), the inverter simultaneously transfers to Alarm mode, displays alarm  on the LED monitor and shuts down its power output.

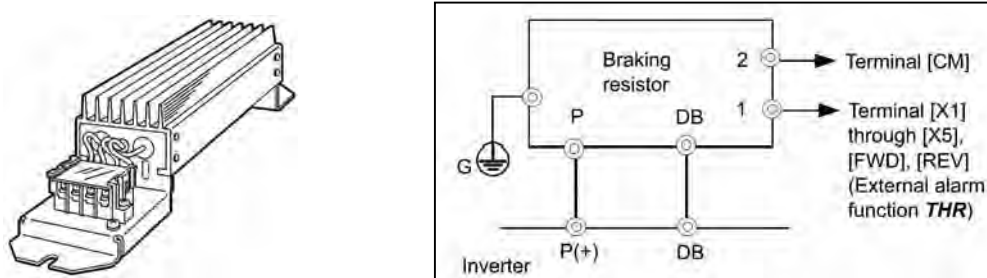

Figure 6.6 Braking Resistor (Standard Model) and Connection Example

Table 6.6 Braking Resistor (Standard Model)

Power supply voltage	Inverter type	Type	Q'ty	Resistance (Ω)	Continuous braking (100% braking torque)		Repetitive braking (each cycle is less than 100 (s))	
					Discharging capability (kW/s)	Braking time (s)	Average allowable loss (kW)	Duty cycle (%ED)
Three-phase 230 V	FRNF12E1S-2U	DB0.75-2	1	100	9	90	0.037	37
	FRNF25E1S-2U						0.044	22
	FRNF50E1S-2U							
	FRN001E1S-2U	0.068		18				
	FRN002E1S-2U				0.075	10		
	FRN003E1S-2U	0.077		7				
	FRN005E1S-2U				0.093	5		
	FRN007E1S-2U	0.138		5				
	FRN010E1S-2U				0.188	5		
	FRN015E1S-2U	0.275		5				
FRN020E1S-2U	0.375		5					
Three-phase 460 V	FRNF50E1S-4U	DB0.75-4	200	9	45	0.044	22	
	FRN001E1S-4U	DB2.2-4	160	17	30	0.068	18	
	FRN002E1S-4U			34		0.075	10	
	FRN003E1S-4U			33		0.077	7	
	FRN005E1S-4U	DB3.7-4	130	37	20	0.093	5	
	FRN007E1S-4U	DB5.5-4	80	55	0.138			
	FRN010E1S-4U	DB7.5-4	60	38	0.188			
	FRN015E1S-4U	DB11-4	40	55	0.275			
	FRN020E1S-4U	DB15-4	34.4	75	0.375	5		
	Single-phase 230 V	FRNF12E1S-7U	DB0.75-2	1	100	9	90	0.037
FRNF25E1S-7U		0.044						22
FRNF50E1S-7U								
FRN001E1S-7U		0.068	18					
FRN002E1S-7U					0.075	10		
FRN003E1S-7U		0.077	7					

[1.2] 10%ED model

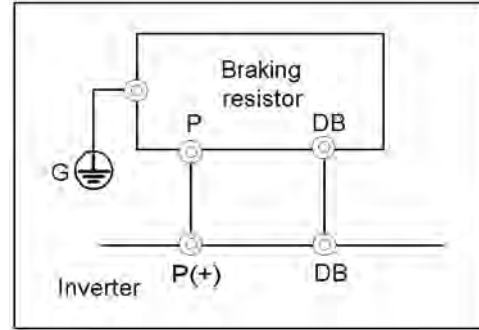
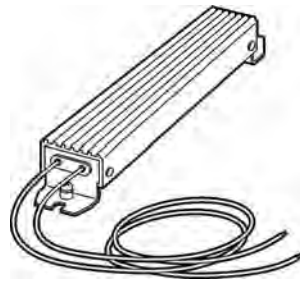

Figure 6.7 Braking Resistor (10%ED Model) and Connection Example

Table 6.7 Braking Resistor (10%ED Model)

Power supply voltage	Inverter type	Type	Q'ty	Resistance (Ω)	Continuous braking (100% braking torque)		Repetitive braking (each cycle is less than 100 (s))	
					Discharging capability (kW)	Braking time (s)	Average allowable loss (kW)	Duty cycle (%ED)
Three-phase 230 V	FRNF12E1S-2U	DB0.75-2C	1	100	50	1000	0.075	100
	FRNF25E1S-2U					500		75
	FRNF50E1S-2U					250		37
	FRN001E1S-2U					133		20
	FRN002E1S-2U	DB2.2-2C		40	55	73	0.110	14
	FRN003E1S-2U			50	10			
	FRN005E1S-2U	DB3.7-2C		33		140	75	0.185
	FRN007E1S-2U	DB5.5-2C		20		55	20	0.275
	FRN010E1S-2U	DB7.5-2C		15		37	10	0.375
	FRN015E1S-2U	DB11-2C		10		55		0.55
	FRN020E1S-2U	DB15-2C		8.6		75		0.75
Three-phase 460 V	FRNF50E1S-4U	DB0.75-4C	1	200		50	250	0.075
	FRN001E1S-4U				133		20	
	FRN002E1S-4U	DB2.2-4C		160	55	73	0.110	14
	FRN003E1S-4U			50	10			
	FRN005E1S-4U	DB3.7-4C		130		140	75	0.185
	FRN007E1S-4U	DB5.5-4C		80		55	20	0.275
	FRN010E1S-4U	DB7.5-4C		60		38	10	0.375
	FRN015E1S-4U	DB11-4C		40		55		0.55
	FRN020E1S-4U	DB15-4C		34.4		75		0.75
Single-phase 230 V	FRNF12E1S-7U	DB0.75-2C	1	100		50	1000	0.075
	FRNF25E1S-7U				500		75	
	FRNF50E1S-7U				250		37	
	FRN001E1S-7U				133		20	
	FRN002E1S-7U	DB2.2-2C		40	55	73	0.110	14
	FRN003E1S-7U			50	10			

The 10%ED braking resistor does not support overheating detection or warning output, so an electronic thermal overload relay needs to be set up using function codes F50 and F51 to protect the braking resistor from overheating.

[1.3] Compact model

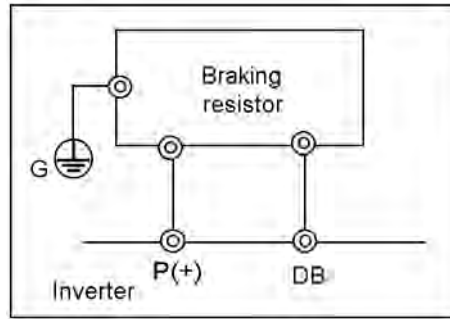
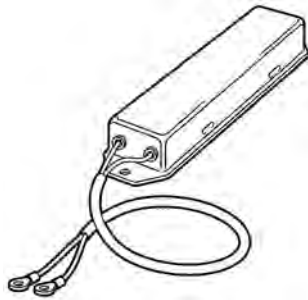

Figure 6.8 Braking Resistor (Compact Model) and Connection Example

Table 6.8 Braking Resistor (Compact Model)

Power supply voltage	Item		TK80W120Ω				
Three-phase 230 V	Resistor	Capacity (kW)	0.08				
		Resistance (Ω)	120				
	Applicable inverter model		FRNF50 E1S-2U	FRN001 E1S-2U	FRN002 E1S-2U	FRN003 E1S-2U	FRN005 E1S-2U
	Nominal applied motor (HP)		1/2	1	2	3	5
	Average braking torque (%)		150	150	150	65	45
	Allowable braking properties	Allowable duty cycle (%)	15	5	5	5	5
		Allowable continuous braking time	15 sec	15 sec	10 sec	10 sec	10 sec
Brake unit		Not required					



This braking resistor is not applicable to three-phase 460 V and single-phase 230 V of inverters.

[2] DC reactors (DCRs)

A DCR is mainly used for power supply matching and for input power factor correction (for reducing harmonic components).

■ For power supply matching

- Use a DCR when the capacity of a power supply transformer exceeds 500 kVA and is 10 times or more the rated inverter capacity. In this case, the percent reactance of the power supply decreases, and harmonic components and their peak value increase. These factors may break rectifiers or capacitors in the converter section of inverter, or decrease the capacitance of the capacitor (which can shorten the inverter's service life).
- Also use a DCR when there are thyristor-driven loads or when phase-advancing capacitors are being turned ON/OFF.
- Use a DCR when the interphase voltage unbalance ratio of the inverter power supply exceeds 2%.

$$\text{Interphase voltage unbalance (\%)} = \frac{\text{Max. voltage (V)} - \text{Min. voltage (V)}}{\text{Three - phase average voltage (V)}} \times 67$$

■ For input power factor correction (for suppressing harmonics)

Generally a capacitor is used to improve the power factor of the load, however, it cannot be used in a system that includes an inverter. Using a DCR increases the reactance of inverter's power supply so as to decrease harmonic components on the power supply lines and improve the power factor of inverter. Using a DCR improves the input power factor to approximately 90% to 95%.



Note

- At the time of shipping, a jumper bar is connected across terminals P1 and P (+) on the terminal block. Remove the jumper bar when connecting a DCR.
- If a DCR is not going to be used, do not remove the jumper bar.

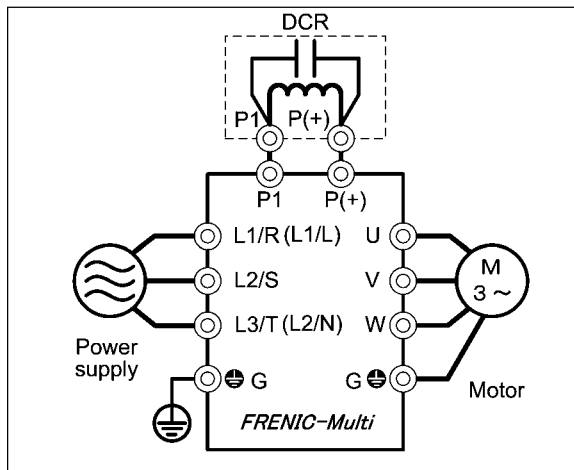
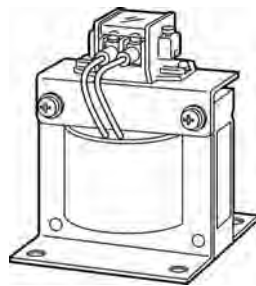

Figure 6.9 External View of a DC Reactor (DCR) and Connection Example

Table 6.9 DC Reactors (DCRs)

Power supply voltage	Nominal applied motor (HP)	Inverter type	DC reactor (DCR)				
			Type	Rated current (A)	Inductance (mH)	Coil resistance (mΩ)	Generated loss (W)
Three-phase 230V	1/8	FRNF12E1S-2U	DCR2-0.2	1.5	20	660	0.8
	1/4	FRNF25E1S-2U					1.6
	1/2	FRNF50E1S-2U	DCR2-0.4	3.0	12	280	1.9
	1	FRN001E1S-2U	DCR2-0.75	5.0	7.0	123	2.8
	2	FRN002E1S-2U	DCR2-1.5	8.0	4.0	57.5	4.6
	3	FRN003E1S-2U	DCR2-2.2	11	3.0	43	6.7
	5	FRN005E1S-2U	DCR2-3.7	18	1.7	21	8.8
	7.5	FRN007E1S-2U	DCR2-5.5	25	1.2	16	14
	10	FRN010E1S-2U	DCR2-7.5	34	0.8	9.7	16
	15	FRN015E1S-2U	DCR2-11	50	0.6	7.0	27
20	FRN020E1S-2U	DCR2-15	67	0.4	4.3		
Three-phase 460V	1/2	FRNF50E1S-4U	DCR4-0.4	1.5	50	970	2.0
	1	FRN001E1S-4U	DCR4-0.75	2.5	30	440	2.5
	2	FRN002E1S-4U	DCR4-1.5	4.0	16	235	4.8
	3	FRN003E1S-4U	DCR4-2.2	5.5	12	172	6.8
	5	FRN005E1S-4U	DCR4-3.7	9.0	7.0	74.5	8.1
	7.5	FRN007E1S-4U	DCR4-5.5	13	4.0	43	10
	10	FRN010E1S-4U	DCR4-7.5	18	3.5	35.5	15
	15	FRN015E1S-4U	DCR4-11	25	2.2	23.2	21
20	FRN020E1S-4U	DCR4-15	34	1.8	18.1	28	
Single-phase 230V	1/8	FRNF12E1S-7U	DCR2-0.2	1.5	20	660	1.6
	1/4	FRNF25E1S-7U	DCR2-0.4	3.0	12	280	1.9
	1/2	FRNF50E1S-7U	DCR2-0.75	5.0	7.0	123	2.8
	1	FRN001E1S-7U	DCR2-1.5	8.0	4.0	57.5	4.6
	2	FRN002E1S-7U	DCR2-3.7	18	1.7	21	8.8
3	FRN003E1S-7U						

Note 1: Generated losses listed in the above table are approximate values that are calculated according to the following conditions:

- The power supply is three-phase 230 V/460 V 50 Hz with 0% interphase voltage unbalance ratio.
- The power supply capacity uses the larger of either 500 kVA or 10 times the rated capacity of the inverter.
- The motor is a 4-pole standard model at full load (100%).
- An AC reactor (ACR) is not connected.

[3] AC reactors (ACRs)

Use an ACR when the converter part of the inverter should supply very stable DC power, for example, in DC link bus operation (shared PN operation). Generally, ACRs are used for correction of voltage waveform and power factor or for power supply matching, but not for suppressing harmonic components in the power lines. For suppressing harmonic components, use a DCR.

An ACR should be also used when the power supply is extremely unstable; for example, when the power supply involves an extremely large interphase voltage unbalance.

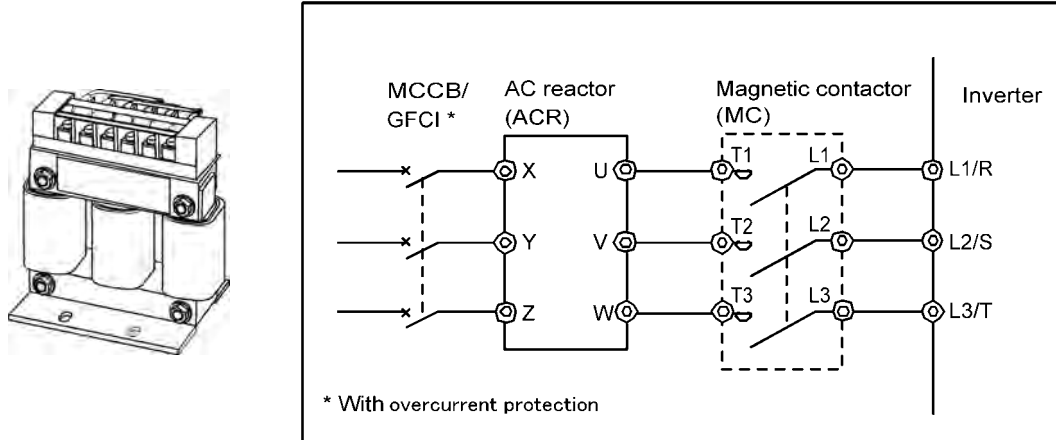

Figure 6.10 External View of AC Reactor (ACR) and Connection Example

Table 6.10 AC Reactor (ACR)

Power supply voltage	Nominal applied motor (HP)	Inverter type	AC reactor (ACR)				
			Type	Rated current (A)	Reactance (mΩ/phase)		Generated loss (W)
					50 Hz	60 Hz	
Three-phase 230V	1/8	FRNF12E1S-2U	ACR2-0.4A	3	917	1100	2.5
	1/4	FRNF25E1S-2U					5
	1/2	FRNF50E1S-2U					10
	1	FRN001E1S-2U	ACR2-0.75A	5	493	592	12
	2	FRN002E1S-2U	ACR2-1.5A	8	295	354	14
	3	FRN003E1S-2U	ACR2-2.2A	11	213	256	16
	5	FRN005E1S-2U	ACR2-3.7A	17	218	153	23
	7.5	FRN007E1S-2U	ACR2-5.5A	25	87.7	105	27
	10	FRN010E1S-2U	ACR2-7.5A	33	65	78	30
Three-phase 460V	15	FRN015E1S-2U	ACR2-11A	46	45.5	54.7	37
	20	FRN020E1S-2U	ACR2-15A	59	34.8	41.8	43
	1/2	FRNF50E1S-4U	ACR4-0.75A	2.5	1920	2300	5
	1	FRN001E1S-4U					10
	2	FRN002E1S-4U					11
	3	FRN003E1S-4U	ACR4-1.5A	3.7	1160	1390	14
	5	FRN005E1S-4U	ACR4-2.2A	5.5	851	1020	17
	7.5	FRN007E1S-4U	ACR4-3.7A	9	512	615	22
	10	FRN010E1S-4U	ACR4-5.5A	13	349	418	27
15	FRN015E1S-4U	ACR4-7.5A	18	256	307	40	
20	FRN020E1S-4U	ACR4-11A	24	183	219	46	
Single-phase 230V	1/8	FRNF12E1S-7U	ACR2-0.4A	3	917	1100	5
	1/4	FRNF25E1S-7U					10
	1/2	FRNF50E1S-7U	ACR2-0.75A	5	493	592	12
	1	FRN001E1S-7U	ACR2-1.5A	8	295	354	14
	2	FRN002E1S-7U	ACR2-2.2A	11	213	256	16
	3	FRN003E1S-7U	ACR2-3.7A	17	218	262	23

Note 1: Generated losses listed in the above table are approximate values that are calculated according to the following conditions:

- The power supply is three-phase 230 V/460 V 50 Hz with 0% interphase voltage unbalance ratio.
- The power supply capacity uses the larger of either 500 kVA or 10 times the rated capacity of the inverter.
- The motor is a 4-pole standard model at full load (100%).

[4] Output circuit filters (OFLs)

Insert an OFL in the inverter power output circuit to:

- Suppress the surge voltage at motor terminal
This protects the motor from insulation damage caused by the application of high voltage surge currents from the 460 V class series of inverters.
- Suppress leakage current (due to higher harmonic components) from the inverter output lines
This reduces the leakage current when the motor is connected by long power feed lines. Keep the length of the power feed line less than 1300 ft (400 m).
- Minimize radiation and/or induction noise issued from the inverter output lines
OFLs are effective noise suppression device for long wiring applications such as that used at plants.

 **Note** Use an ACR within the allowable carrier frequency range specified by function code F26. Otherwise, the filter will overheat.

Table 6.11 Output Circuit Filter (OFL)

Power supply voltage	Nominal applied motor (HP)	Inverter type	Filter type	Rated current (A)	Overload capability	Inverter power input voltage	Carrier frequency - allowable range (kHz)	Maximum frequency (Hz)
Three-phase 230V	1/8	FRNF12E1S-2U	OFL-0.4-2	3	150% for 1 min. 200% for 0.5 sec	Three-phase 200 to 240 V 50/60 Hz	8 to 15	400
	1/4	FRNF25E1S-2U						
	1/2	FRNF50E1S-2U						
	1	FRN001E1S-2U	OFL-1.5-2	8				
	2	FRN002E1S-2U						
	3	FRN003E1S-2U	OFL-3.7-2	17				
	5	FRN005E1S-2U						
	7.5	FRN007E1S-2U	OFL-7.5-2	33				
	10	FRN010E1S-2U						
15	FRN015E1S-2U	OFL-15-2	59					
20	FRN020E1S-2U							
Three-phase 460V	1/2	FRNF50E1S-4U	OFL-0.4-4	1.5	150% for 1 min. 200% for 0.5 sec	Three-phase 380 to 440 V 50/60 Hz	8 to 15	400
	1	FRN001E1S-4U	OFL-1.5-4	3.7				
	2	FRN002E1S-4U	OFL-3.7-4	9				
	3	FRN003E1S-4U						
	5	FRN005E1S-4U	OFL-7.5-4	18				
	7.5	FRN007E1S-4U						
	10	FRN010E1S-4U	OFL-15-4	30				
15	FRN015E1S-4U							
20	FRN020E1S-4U							
Three-phase 460V	1/2	FRNF50E1S-4U	OFL-0.4-4A	1.5	150% for 1 min. 200% for 0.5 sec	Three-phase 380 to 480 V 50/60 Hz	0.75 to 15	400
	1	FRN001E1S-4U	OFL-1.5-4A	3.7				
	2	FRN002E1S-4U	OFL-3.7-4A	9				
	3	FRN003E1S-4U						
	5	FRN005E1S-4U	OFL-7.5-4A	18				
	7.5	FRN007E1S-4U						
	10	FRN010E1S-4U	OFL-15-4A	30				
15	FRN015E1S-4U							
20	FRN020E1S-4U							
Single-phase 230V	1/8	FRNF12E1S-7U	OFL-0.4-2	3	150% for 1 min. 200% for 0.5 sec	Three-phase 380 to 480 V 50/60 Hz	8 to 15	400
	1/4	FRNF25E1S-7U						
	1/2	FRNF50E1S-7U						
	1	FRN001E1S-7U	OFL-1.5-2	8				
	2	FRN002E1S-7U						
3	FRN003E1S-7U	OFL-3.7-2	17					

Note 1: The OFL-***-4A models have no restrictions on carrier frequency.

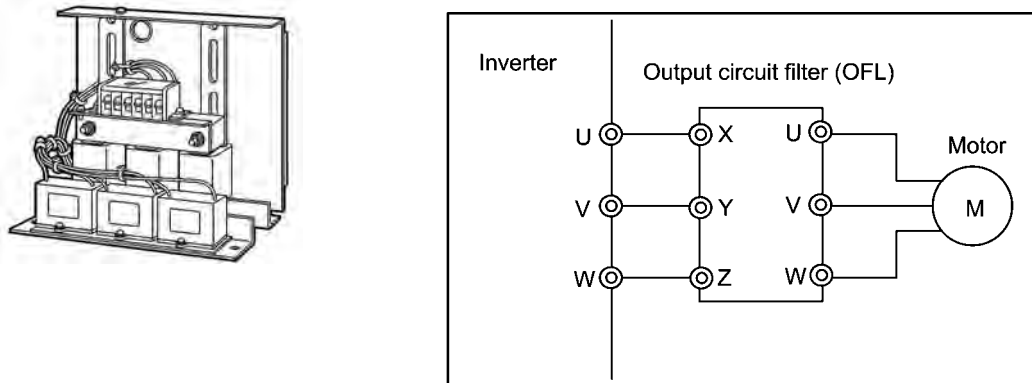

Figure 6.11 External View of Output Circuit Filter (OFL) and Connection Example

[5] Zero-phase reactor for reducing radio noise (ACL)

An ACL is used to reduce radio frequency noise emitted by the inverter.

An ACL suppresses the outflow of high frequency harmonics caused by switching operation for the power supply lines inside the inverter. Pass the power supply lines together through the ACL.

If wiring length between the inverter and motor is less than 66 ft (20 m), insert an ACL to the power supply lines; if it is more than 66 ft (20 m), insert it to the power output lines of the inverter.

Wire size is determined depending upon the ACL size (I.D.) and installation requirements.

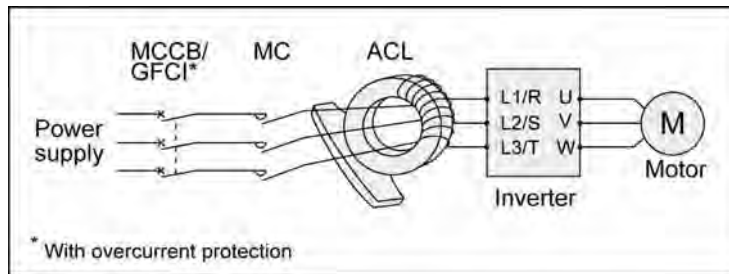
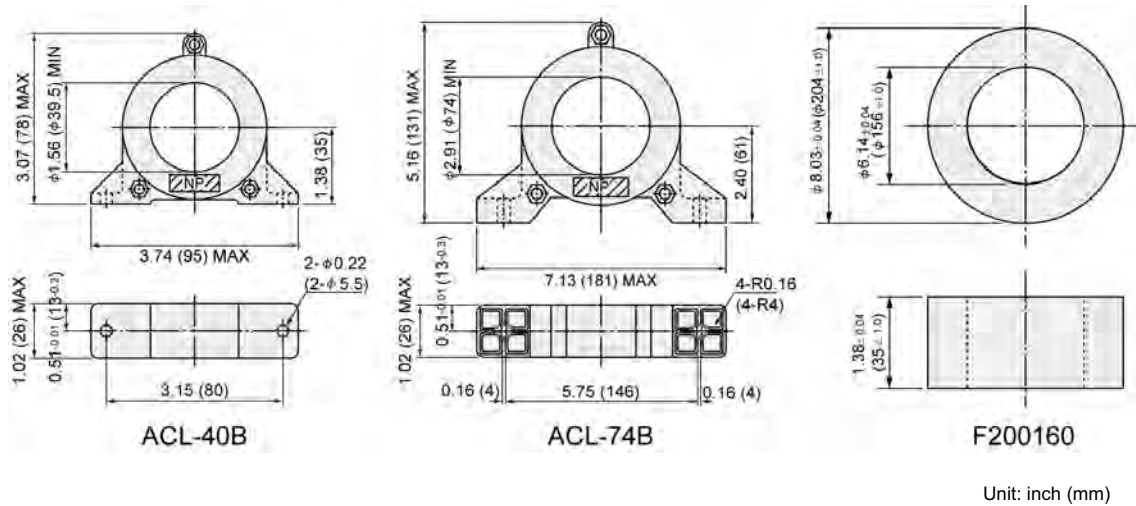

Figure 6.12 Dimensions of Zero-phase Reactor for Reducing Radio Noise (ACL) and Connection Example

Table 6.12 Zero-phase Reactor for Reducing Radio Noise (ACL)

Zero-phase reactor type	Installation requirements		Wire size (mm ²)
	Qty.	Number of turns	
ACL-40B	1	4	2.0
			3.5
			5.5
	2	2	8
ACL-74B	1	4	14
			8
			14
	2	2	22
			38

The selected wires are for use with 3-phase input/output lines (3 wires).

6.4.2 Options for operation and communications

[1] External potentiometer for frequency setting

An external potentiometer may be used to set the drive frequency. Connect the potentiometer to control signal terminals [11] through [13] of the inverter as shown in Figure 6.13.

Model: RJ-13 (BA-2 B-characteristics, 1 kΩ)

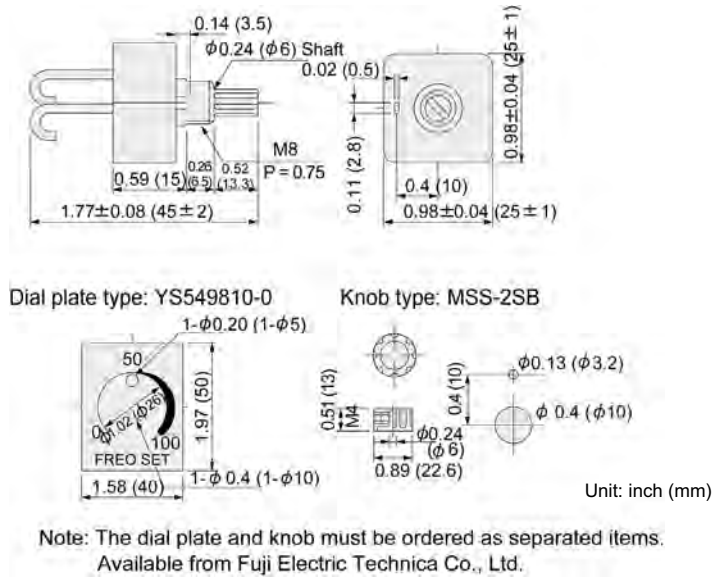

Model: WAR3W (3W B-characteristics, 1 kΩ)

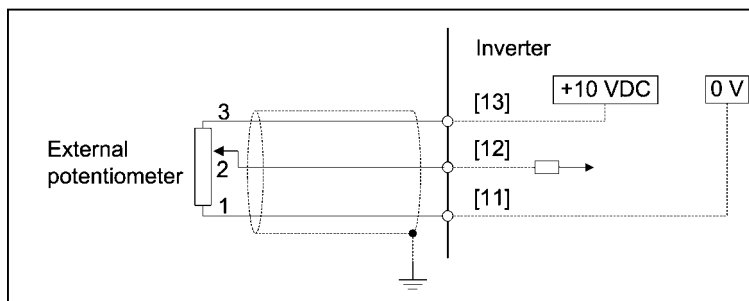
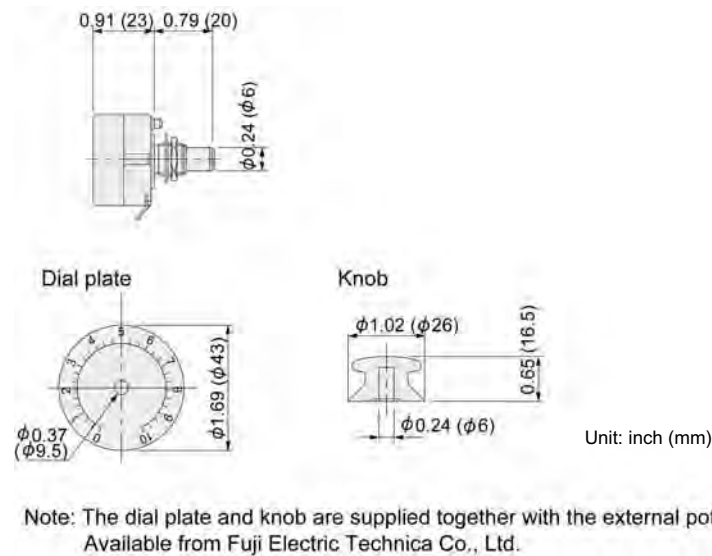

Figure 6.13 External Potentiometer Dimensions and Connection Example

[2] Multi-function keypad

Connecting the multi-function keypad on a FRENIC-Multi series inverter with an optional remote operation extension cable (CB-5S, CB-3S, or CB-1S) allows you to operate the inverter locally or remotely (from the keypad in hand or mounted on a panel), respectively.

In addition, the multi-function keypad can be used for copying function code data from a FRENIC-Multi series inverter to other ones (up to three inverters of function code data).



[3] Extension cable for remote operation

The extension cable connects the inverter with the keypad (standard or multi-function) or USB—RS-485 converter to enable remote operation of the inverter. The cable is a straight type with RJ-45 jacks and its length is selectable from 16, 9.3, and 3.3 ft (5, 3, and 1 m).

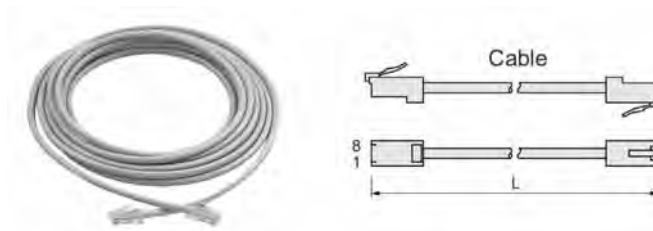

Table 6.13 Extension Cable Length for Remote Operation

Type	Length [ft (m)]
CB-5S	16 (5)
CB-3S	9.8 (3)
CB-1S	3.3 (1)

[4] RS-485 communications card

The RS-485 communications card (2-port) is exclusively designed for use with the FRENIC-Multi series of inverters other than with the standard port of the inverter, and enables extended RS-485 communication in addition to the standard RS-485 communication (via the RJ-45 connector for connecting the keypad.)

The main functions include the following:

- Connecting the inverter to host equipment such as a PC or PLC, which enables the inverter to be controlled as a slave device.
- Operating the inverters by frequency command setting, forward/reverse running/stopping, coast-to-stop and resetting, etc.
- Monitoring the operation status of the inverter, e.g., output frequency, output current and alarm information, etc.
- Setting function code data.

Table 6.14 Transmission Specifications

Item	Specifications		
Communication protocol	SX protocol (for exclusive use with FRENIC Loader)	Modbus RTU (Conforming to Modicon's Modbus RTU)	Fuji general-purpose inverter protocol
Electrical specifications	EIA RS-485		
Maximum number of units connected	Host: 1 unit, Inverter: 31 units		
Transmission rate	2400, 4800, 9600, 19200, and 38400 bps		
Synchronization system	Asynchronous start-stop system		
Transmission method	Half-duplex		
Maximum length of communication network	1600 ft (500 m)		



[5] Inverter support loader software

FRENIC Loader is support software which enables the inverter to be operated via the RS-485 communications facility. The main functions include the following:

- Easy editing of function code data
- Monitoring the operation statuses of the inverter such as I/O monitor and multi-monitor
- Operation of inverters on a PC screen (Windows-based only)

 Refer to Chapter 5 "RUNNING THROUGH RS-485 COMMUNICATION (OPTION)" for details.

6.4.3 Meter options

[1] Frequency meters

Connect a frequency meter to analog signal output terminals [FM] and [11] of the inverter to measure the frequency component selected by function code F31. Figure 6.14 shows the dimensions of the frequency meter and a connection example.

Model: TRM-45 (10 VDC, 1 mA)

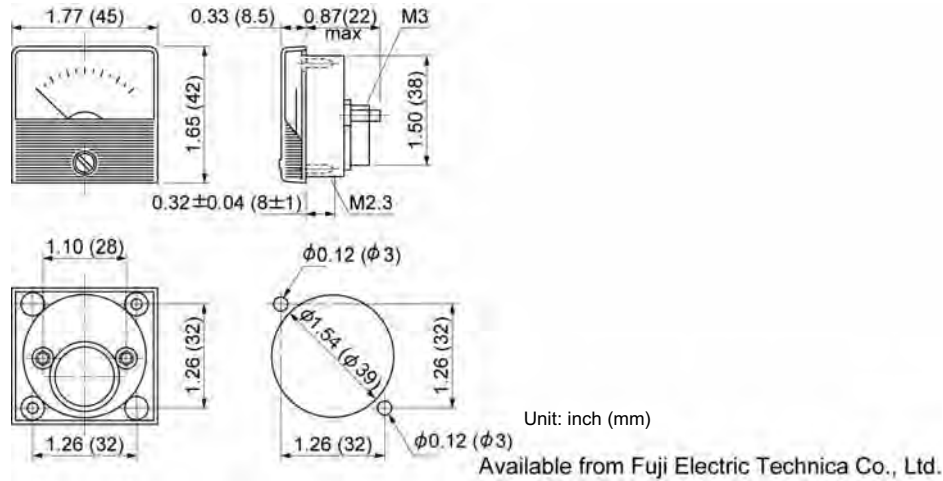

Model: FM-60 (10 VDC, 1 mA)

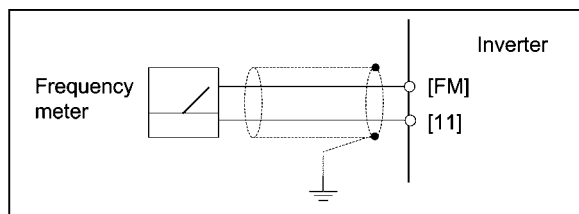
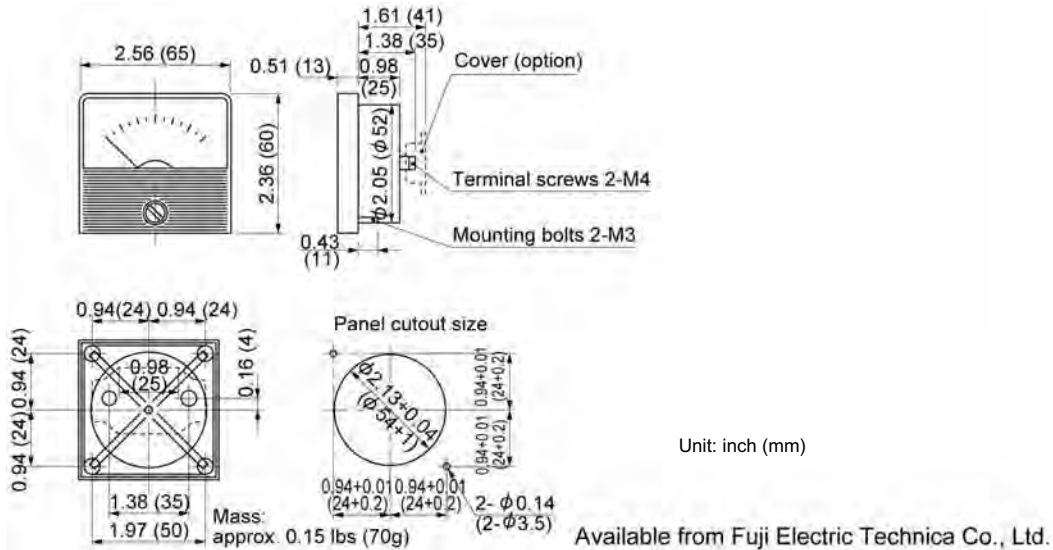

Figure 6.14 Frequency Meter Dimensions and Connection Example

Part 4 Selecting Optimal Inverter Model

Chapter 7 SELECTING OPTIMAL MOTOR AND INVERTER CAPACITIES

Chapter 7

SELECTING OPTIMAL MOTOR AND INVERTER CAPACITIES

This chapter provides you with information about the inverter output torque characteristics, selection procedure, and equations for calculating capacities to help you select optimal motor and inverter models. It also helps you select braking resistors.

Contents

7.1	Selecting Motors and Inverters	7-1
7.1.1	Motor output torque characteristics.....	7-1
7.1.2	Selection procedure.....	7-4
7.1.3	Equations for selections	7-7
7.1.3.1	Load torque during constant speed running	7-7
[1]	General equation	7-7
[2]	Obtaining the required force F	7-7
7.1.3.2	Acceleration and deceleration time calculation.....	7-8
[1]	Calculation of moment of inertia.....	7-8
[2]	Calculation of the acceleration time.....	7-10
[3]	Calculation of the deceleration time.....	7-10
7.1.3.3	Heat energy calculation of braking resistor.....	7-11
[1]	Calculation of regenerative energy.....	7-11
7.1.3.4	Calculating the RMS rating of the motor	7-12
7.2	Selecting a Braking Resistor	7-13
7.2.1	Selection procedure.....	7-13
7.2.2	Notes on selection	7-13

7.1 Selecting Motors and Inverters

When selecting a general-purpose inverter, first select a motor and then inverter as follows:

- (1) Key point for selecting a motor: Determine what kind of load machine is to be used, calculate its moment of inertia, and then select the appropriate motor capacity.
- (2) Key point for selecting an inverter: Taking into account the operation requirements (e.g., acceleration time, deceleration time, and frequency in operation) of the load machine to be driven by the motor selected in (1) above, calculate the acceleration/deceleration/braking torque.

This section describes the selection procedure for (1) and (2) above. First, it explains the output torque obtained by using the motor driven by the inverter (FRENIC-Multi).

7.1.1 Motor output torque characteristics

Figures 7.1 and 7.2 graph the output torque characteristics of motors at the rated output frequency individually for 50 Hz and 60 Hz base. The horizontal and vertical axes show the output frequency and output torque (%), respectively. Curves (a) through (f) depend on the running conditions.

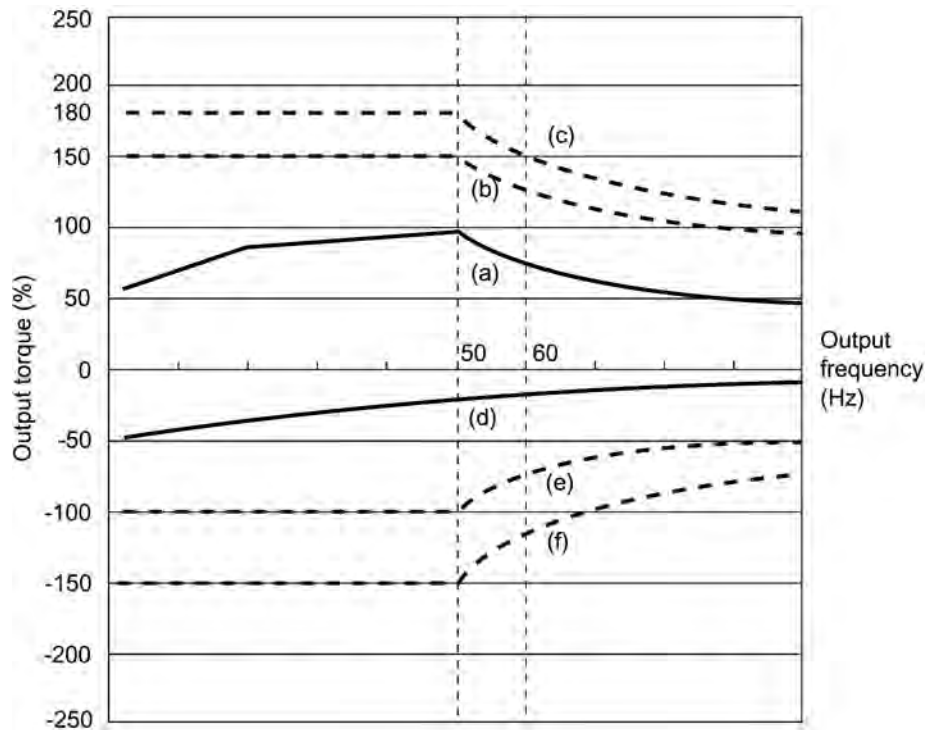

Figure 7.1 Output Torque Characteristics (Base frequency: 50 Hz)

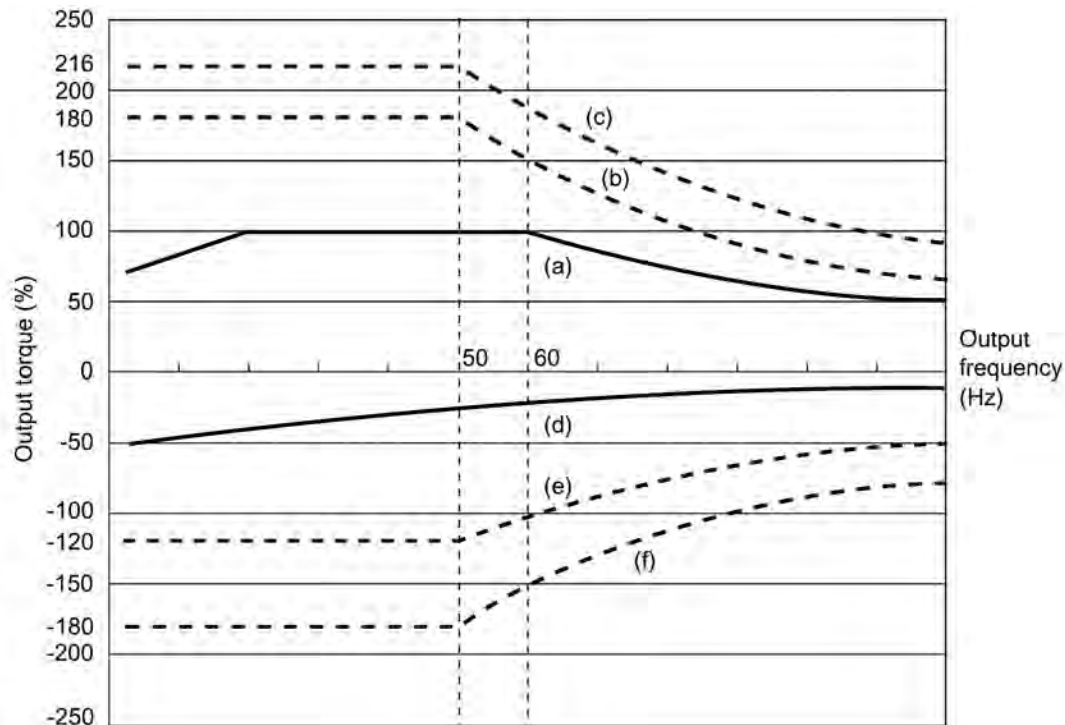

Figure 7.2 Output Torque Characteristics (Base frequency: 60 Hz)

(1) Continuous allowable driving torque (Curve (a) in Figures 7.1 and 7.2)

Curve (a) shows the torque characteristic that can be obtained in the range of the inverter continuous rated current, where the motor cooling characteristic is taken into consideration. When the motor runs at the base frequency of 60 Hz, 100 % output torque can be obtained; at 50 Hz, the output torque is somewhat lower than that in commercial power, and it further lowers at lower frequencies. The reduction of the output torque at 50 Hz is due to increased loss by inverter driving, and that at lower frequencies is mainly due to heat generation caused by the decreased ventilation performance of the motor cooling fan.

(2) Maximum driving torque in a short time (Curves (b) and (c) in Figures 7.1 and 7.2)

Curve (b) shows the torque characteristic that can be obtained in the range of the inverter rated current in a short time (the output torque is 150% for one minute) when torque-vector control is enabled. At that time, the motor cooling characteristics have little effect on the output torque.

Curve (c) shows an example of the torque characteristic when one class higher capacity inverter is used to increase the short-time maximum torque. In this case, the short-time torque is 20 to 30% greater than that when the standard capacity inverter is used.

(3) Starting torque (around the output frequency 0 Hz in Figures 7.1 and 7.2)

The maximum torque in a short time applies to the starting torque as it is.

(4) Braking torque (Curves (d), (e), and (f) in Figures 7.1 and 7.2)

In braking the motor, kinetic energy is converted to electrical energy and regenerated to the DC link bus capacitor (reservoir capacitor) of the inverter. Discharging this electrical energy to the braking resistor produces a large braking torque as shown in curve (e). If no braking resistor is provided, however, only the motor and inverter losses consume the regenerated braking energy so that the torque becomes smaller as shown in curve (d).

When an optional braking resistor is used, the braking torque is allowable only for a short time. Its time ratings are mainly determined by the braking resistor ratings. This manual and associated catalogs list the allowable values (kW) obtained from the average discharging loss and allowable values (kWs) obtained from the discharging capability that can be discharged at one time.

Note that the torque % value varies according to the inverter capacity.

Selecting an optimal brake unit enables a braking torque value to be selected comparatively freely in the range below the short-time maximum torque in the driving mode, as shown in curve (f).

 For braking-related values when the inverter and braking resistor are normally combined, refer to Chapter 6, Section 6.4.1 [1] "Braking resistors."

7.1.2 Selection procedure

Figure 7.3 shows the general selection procedure for optimal inverters. Items numbered (1) through (5) are described on the following pages.

You may easily select inverter capacity if there are no restrictions on acceleration and deceleration times. If "there are any restrictions on acceleration or deceleration time" or "acceleration and deceleration are frequent," then the selection procedure is more complex.

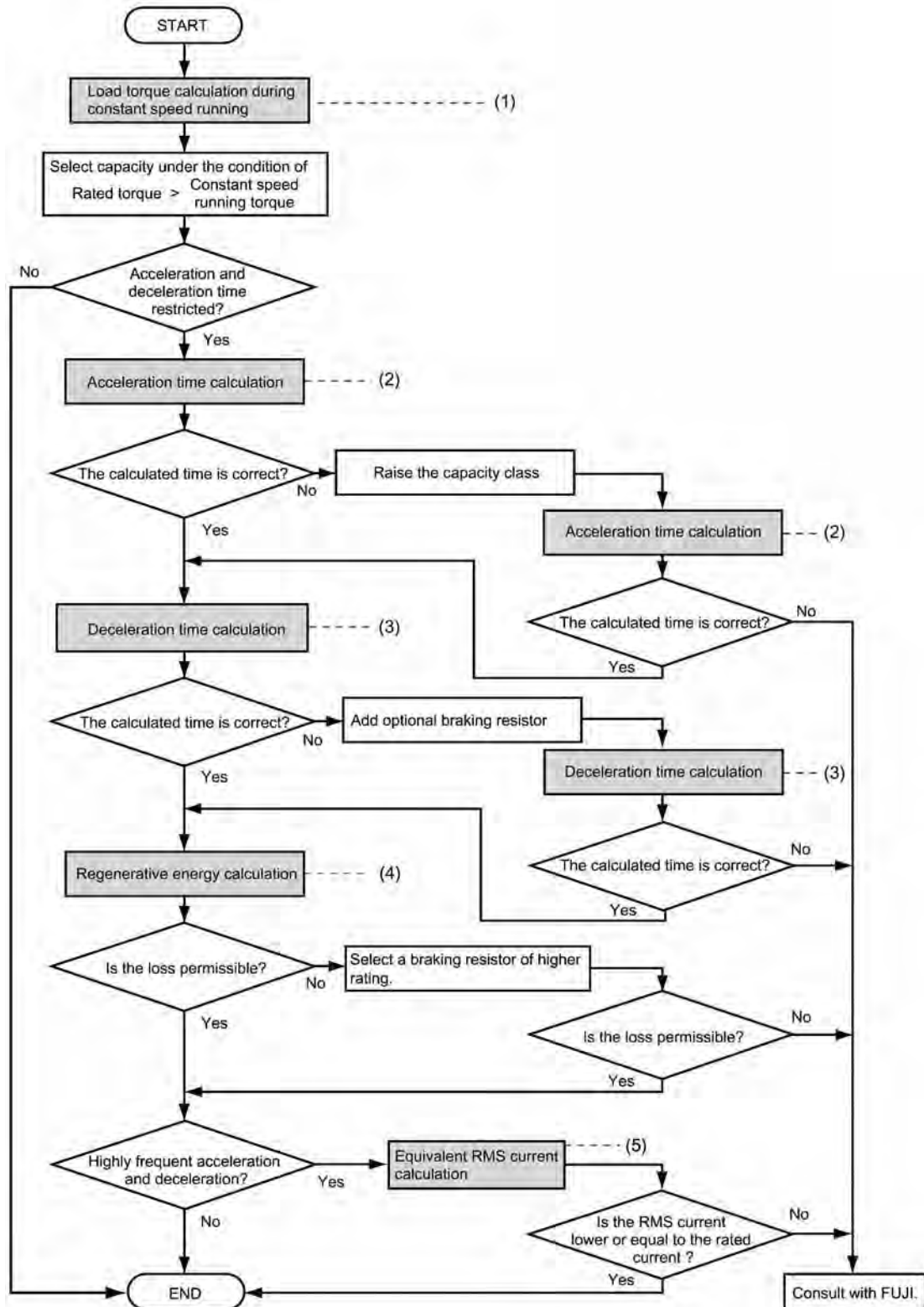

Figure 7.3 Selection Procedure

- (1) Calculating the load torque during constant speed running (For detailed calculation, refer to Section 7.1.3.1)

It is essential to calculate the load torque during constant speed running for all loads.

First calculate the load torque of the motor during constant speed running and then select a tentative capacity so that the continuous rated torque of the motor during constant speed running becomes higher than the load torque. To perform capacity selection efficiently, it is necessary to match the rated speeds (base speeds) of the motor and load. To do this, select an appropriate reduction-gear (mechanical transmission) ratio and the number of motor poles.

If the acceleration or deceleration time is not restricted, the tentative capacity can apply as a defined capacity.

- (2) Calculating the acceleration time (For detailed calculation, refer to Section 7.1.3.2)

When there are some specified requirements for the acceleration time, calculate it according to the following procedure:

- 1) Calculate the moment of inertia for the load and motor
Calculate the moment of inertia for the load, referring to Section 7.1.3.2, "Acceleration and deceleration time calculation." For the motor, refer to the related motor catalogs.
- 2) Calculate the minimum acceleration torque (See Figure 7.4)
The acceleration torque is the difference between the motor short-time output torque (base frequency: 60 Hz) explained in Section 7.1.1 (2), "Maximum driving torque in a short time" and the load torque (τ_L / η_G) during constant speed running calculated in the above (1). Calculate the minimum acceleration torque for the whole range of speed.
- 3) Calculate the acceleration time
Assign the value calculated above to the equation (7.10) in Section 7.1.3.2, "Acceleration and deceleration time calculation" to calculate the acceleration time. If the calculated acceleration time is longer than the expected time, select the inverter and motor having one class larger capacity and calculate it again.

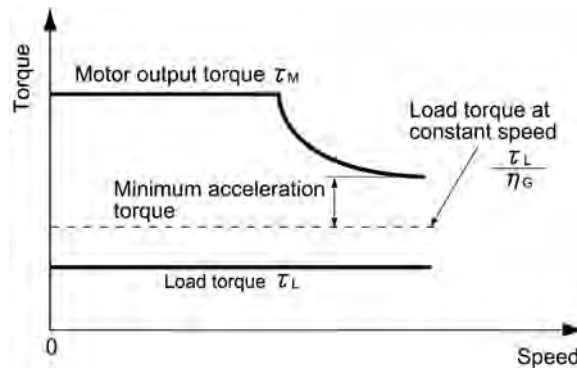

Figure 7.4 Example Study of Minimum Acceleration Torque

(3) Deceleration time (For detailed calculation, refer to Section 7.1.3.2)

To calculate the deceleration time, check the motor deceleration torque characteristics for the whole range of speed in the same way as for the acceleration time.

- 1) Calculate the moment of inertia for the load and motor
Same as for the acceleration time.
- 2) Calculate the minimum deceleration torque (See Figures 7.5 and 7.6.)
Same as for the deceleration time.
- 3) Calculate the deceleration time
Assign the value calculated above to the equation (7.11) to calculate the deceleration time in the same way as for the acceleration time. If the calculated deceleration time is longer than the requested time, select the inverter and motor having one class larger capacity and calculate it again.

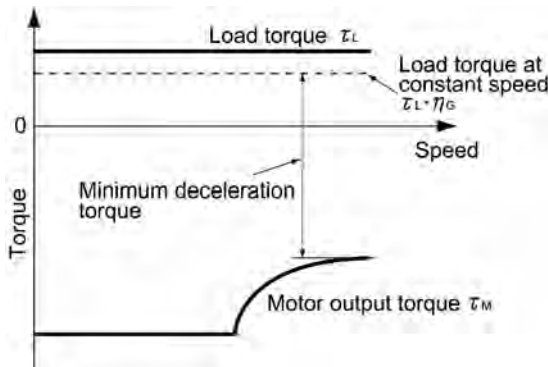

Figure 7.5 Example Study of Minimum Deceleration Torque (1)

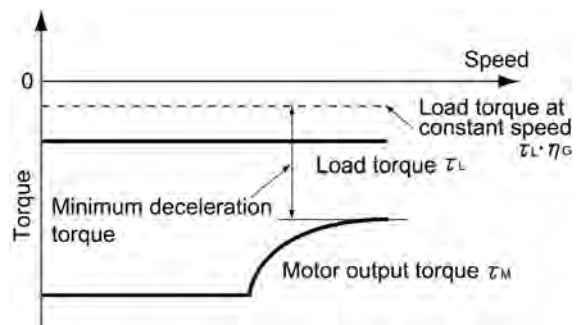

Figure 7.6 Example Study of Minimum Deceleration Torque (2)

(4) Braking resistor rating (For detailed calculation, refer to Section 7.1.3.3)

Braking resistor rating is classified into two types according to the braking periodic duty cycle.

- 1) When the periodic duty cycle is shorter than 100 sec:
Calculate the average loss to determine rated values.
- 2) When the periodic duty cycle is 100 sec or longer:
The allowable braking energy depends on the maximum regenerative braking capacity. The allowable values are listed in Chapter 6, Section 6.4.1 [1] "Braking resistors."

(5) Motor RMS current (For detailed calculation, refer to Section 7.1.3.4)

In metal processing machine and materials handling machines requiring positioning control, highly frequent running for a short time is repeated. In this case, calculate the maximum equivalent RMS current value (effective value of current) not to exceed the allowable value (rated current) for the motor.

7.1.3 Equations for selections

7.1.3.1 Load torque during constant speed running

[1] General equation

The frictional force acting on a horizontally moved load must be calculated. Calculation for driving a load along a straight line with the motor is shown below.

Where the force to move a load linearly at constant speed v (m/s) is F (N) and the motor speed for driving this is N_M (r/min), the required motor output torque τ_M (N·m) is as follows:

$$\tau_M = \frac{60 \cdot v}{2 \pi \cdot N_M} \cdot \frac{F}{\eta_G} \quad (\text{N} \cdot \text{m}) \quad (7.1)$$

where, η_G is Reduction-gear efficiency.

When the inverter brakes the motor, efficiency works inversely, so the required motor torque should be calculated as follows:

$$\tau_M = \frac{60 \cdot v}{2 \pi \cdot N_M} \cdot F \cdot \eta_G \quad (\text{N} \cdot \text{m}) \quad (7.2)$$

$(60 \cdot v) / (2 \pi \cdot N_M)$ in the above equation is an equivalent turning radius corresponding to speed v (m/s) around the motor shaft.

The value F (N) in the above equations depends on the load type.

[2] Obtaining the required force F

Moving a load horizontally

A simplified mechanical configuration is assumed as shown in Figure 7.7. If the mass of the carrier table is W_0 (kg), the load is W (kg), and the friction coefficient of the ball screw is μ , then the friction force F (N) is expressed as follows, which is equal to a required force for driving the load:

$$F = (W_0 + W) \cdot g \cdot \mu \quad (\text{N}) \quad (7.3)$$

where, g is the gravity acceleration (≈ 9.8 (m/s²)).

Then, the driving torque around the motor shaft is expressed as follows:

$$\tau_M = \frac{60 \cdot v}{2 \pi \cdot N_M} \cdot \frac{(W_0 + W) \cdot g \cdot \mu}{\eta_G} \quad (\text{N} \cdot \text{m}) \quad (7.4)$$

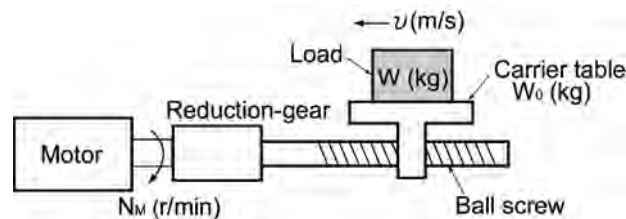

Figure 7.7 Moving a Load Horizontally

7.1.3.2 Acceleration and deceleration time calculation

When an object whose moment of inertia is J ($\text{kg}\cdot\text{m}^2$) rotates at the speed N (r/min), it has the following kinetic energy:

$$E = \frac{J}{2} \cdot \left(\frac{2\pi \cdot N}{60}\right)^2 \quad (\text{J}) \quad (7.5)$$

To accelerate the above rotational object, the kinetic energy will be increased; to decelerate the object, the kinetic energy must be discharged. The torque required for acceleration and deceleration can be expressed as follows:

$$\tau = J \cdot \frac{2\pi}{60} \left(\frac{dN}{dt}\right) \quad (\text{N}\cdot\text{m}) \quad (7.6)$$

This way, the mechanical moment of inertia is an important element in the acceleration and deceleration. First, calculation method of moment of inertia is described, then those for acceleration and deceleration time are explained.

[1] Calculation of moment of inertia

For an object that rotates around the shaft, virtually divide the object into small segments and square the distance from the shaft to each segment. Then, sum the squares of the distances and the masses of the segments to calculate the moment of inertia.

$$J = \sum(W_i \cdot r_i^2) \quad (\text{kg}\cdot\text{m}^2) \quad (7.7)$$

The following describes equations to calculate moment of inertia having different shaped loads or load systems.

(1) Hollow cylinder and solid cylinder

The common shape of a rotating body is hollow cylinder. The moment of inertia J ($\text{kg}\cdot\text{m}^2$) around the hollow cylinder center axis can be calculated as follows, where the outer and inner diameters are D_1 and D_2 [m] and total mass is W [kg] in Figure 7.8.

$$J = \frac{W \cdot (D_1^2 + D_2^2)}{8} \quad (\text{kg}\cdot\text{m}^2) \quad (7.8)$$

For a similar shape, a solid cylinder, calculate the moment of inertia as D_2 is 0.

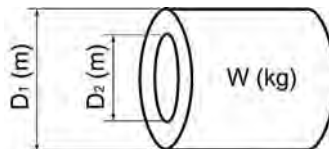
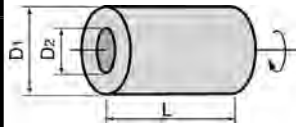
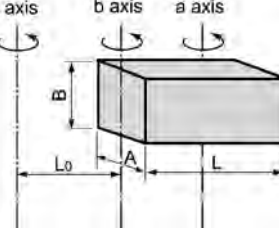
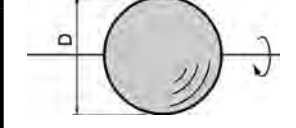
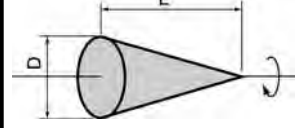
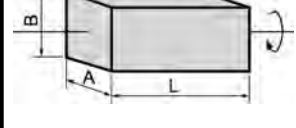
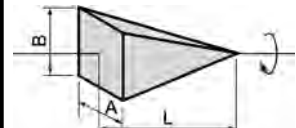
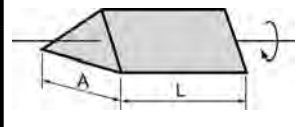
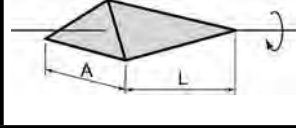

Figure 7.8 Hollow Cylinder

(2) For a general rotating body

Table 7.1 lists the calculation equations of moment of inertia of various rotating bodies including the above cylindrical rotating body.

Table 7.1 Moment of Inertia of Various Rotating Bodies

Shape	Mass: W (kg) Moment of inertia: J (kg·m ²)	Shape	Mass: W (kg) Moment of inertia: J (kg·m ²)
Hollow cylinder 	$W = \frac{\pi}{4} \cdot (D_1^2 - D_2^2) \cdot L \cdot \rho$ $J = \frac{1}{8} \cdot W \cdot (D_1^2 + D_2^2)$	Rectangular prism 	$W = A \cdot B \cdot L \cdot \rho$ $J_a = \frac{1}{12} \cdot W \cdot (L^2 + A^2)$ $J_b = \frac{1}{12} \cdot W \cdot (L^2 + \frac{1}{4} \cdot A^2)$ $J_c \approx W \cdot (L_0^2 + L_0 \cdot L + \frac{1}{3} \cdot L^2)$
Sphere 	$W = \frac{\pi}{6} \cdot D^3 \cdot \rho$ $J = \frac{1}{10} \cdot W \cdot D^2$	Cone 	$W = \frac{\pi}{4} \cdot D^2 \cdot L \cdot \rho$ $J_a = \frac{1}{12} \cdot W \cdot (L^2 + \frac{3}{4} \cdot D^2)$ $J_b = \frac{1}{3} \cdot W \cdot (L^2 + \frac{3}{16} \cdot D^2)$ $J_c \approx W \cdot (L_0^2 + L_0 \cdot L + \frac{1}{3} \cdot L^2)$
Rectangular prism 	$W = A \cdot B \cdot L \cdot \rho$ $J = \frac{1}{12} \cdot W \cdot (A^2 + B^2)$	Square cone (Pyramid, rectangular base) 	$W = \frac{1}{3} \cdot A \cdot B \cdot L \cdot \rho$ $J_b = \frac{1}{10} \cdot W \cdot (L^2 + \frac{1}{4} \cdot A^2)$ $J_c \approx W \cdot (L_0^2 + \frac{3}{2} \cdot L_0 \cdot L + \frac{3}{5} \cdot L^2)$
Triangular prism 	$W = \frac{\sqrt{3}}{4} \cdot A^2 \cdot L \cdot \rho$ $J = \frac{1}{3} \cdot W \cdot A^2$	Tetrahedron with an equilateral triangular base 	$W = \frac{\pi}{12} \cdot D^2 \cdot L \cdot \rho$ $J_b = \frac{1}{10} \cdot W \cdot (L^2 + \frac{3}{8} \cdot D^2)$ $J_c \approx W \cdot (L_0^2 + \frac{3}{2} \cdot L_0 \cdot L + \frac{3}{5} \cdot L^2)$

Main metal density (at 20°C) ρ(kg/m³) Iron: 7860, Copper: 8940, Aluminum: 2700

(3) For a load running horizontally

Assume a carrier table driven by a motor as shown in Figure 7.7. If the table speed is v (m/s) when the motor speed is N_M (r/min), then an equivalent distance from the shaft is equal to $60 \cdot v / (2\pi \cdot N_M)$ (m). The moment of inertia of the table and load to the shaft is calculated as follows:

$$J = \left(\frac{60 \cdot v}{2\pi \cdot N_M} \right)^2 \cdot (W_0 + W) \quad (\text{kg} \cdot \text{m}^2) \quad (7.9)$$

[2] Calculation of the acceleration time

Figure 7.9 shows a general load model. Assume that a motor drives a load via a reduction-gear with efficiency η_G . The time required to accelerate this load in stop state to a speed of N_M (r/min) is calculated with the following equation:

$$t_{\text{ACC}} = \frac{J_1 + J_2/\eta_G}{\tau_M - \tau_L/\eta_G} \cdot \frac{2\pi \cdot (N_M - 0)}{60} \quad (\text{s}) \quad (7.10)$$

where,

J_1 : Motor shaft moment of inertia ($\text{kg} \cdot \text{m}^2$)

J_2 : Load shaft moment of inertia converted to motor shaft ($\text{kg} \cdot \text{m}^2$)

τ_M : Minimum motor output torque in driving motor ($\text{N} \cdot \text{m}$)

τ_L : Maximum load torque converted to motor shaft ($\text{N} \cdot \text{m}$)

η_G : Reduction-gear efficiency.

As clarified in the above equation, the equivalent moment of inertia becomes $(J_1 + J_2/\eta_G)$ by considering the reduction-gear efficiency.

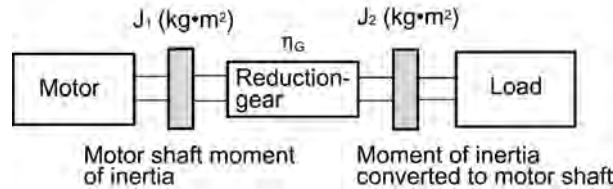

Figure 7.9 Load Model Including Reduction-gear

[3] Calculation of the deceleration time

In a load system shown in Figure 7.9, the time needed to stop the motor rotating at a speed of N_M (r/min) is calculated with the following equation:

$$t_{\text{DEC}} = \frac{J_1 + J_2 \cdot \eta_G}{\tau_M - \tau_L \cdot \eta_G} \cdot \frac{2\pi \cdot (0 - N_M)}{60} \quad (\text{s}) \quad (7.11)$$

where,

J_1 : Motor shaft moment of inertia ($\text{kg} \cdot \text{m}^2$)

J_2 : Load shaft moment of inertia converted to motor shaft ($\text{kg} \cdot \text{m}^2$)

τ_M : Minimum motor output torque in braking (or decelerating) motor ($\text{N} \cdot \text{m}$)

τ_L : Maximum load torque converted to motor shaft ($\text{N} \cdot \text{m}$)

η_G : Reduction-gear efficiency

In the above equation, generally output torque τ_M is negative and load torque τ_L is positive. So, deceleration time becomes shorter.

7.1.3.3 Heat energy calculation of braking resistor

If the inverter brakes the motor, the kinetic energy of mechanical load is converted to electric energy to be regenerated into the inverter circuit. This regenerative energy is often consumed in so-called braking resistors as heat. The following explains the braking resistor rating.

[1] Calculation of regenerative energy

In the inverter operation, one of the regenerative energy sources is the kinetic energy that is generated at the time an object is moved by an inertial force.

Kinetic energy of a moving object

When an object with moment of inertia J ($\text{kg}\cdot\text{m}^2$) rotates at a speed N_2 (r/min), its kinetic energy is as follows:

$$E = \frac{J}{2} \cdot \left(\frac{2\pi \cdot N_2}{60} \right)^2 \quad (\text{J}) \quad (7.12)$$

$$\approx \frac{1}{182.4} \cdot J \cdot N_2^2 \quad (\text{J}) \quad (7.12)'$$

When this object is decelerated to a speed N_1 (r/min), the output energy is as follows:

$$E = \frac{J}{2} \cdot \left[\left(\frac{2\pi \cdot N_2}{60} \right)^2 - \left(\frac{2\pi \cdot N_1}{60} \right)^2 \right] \quad (\text{J}) \quad (7.13)$$

$$\approx \frac{1}{182.4} \cdot J \cdot (N_2^2 - N_1^2) \quad (\text{J}) \quad (7.13)'$$

The energy regenerated to the inverter as shown in Figure 7.9 is calculated from the reduction-gear efficiency η_G and motor efficiency τ_M as follows:

$$E \approx \frac{1}{182.4} \cdot (J_1 + J_2 \cdot \eta_G) \cdot \eta_M \cdot (N_2^2 - N_1^2) \quad (\text{J}) \quad (7.14)$$

7.1.3.4 Calculating the RMS rating of the motor

In case of the load which is repeatedly and very frequently driven by a motor, the motor current fluctuates largely and enters the short-time rating range of the motor repeatedly. Therefore, you have to review the allowable thermal rating of the motor. The heat value is assumed to be approximately proportional to the square of the motor current.

If an inverter drives a motor in duty cycles that are much shorter than the thermal time constant of the motor, calculate the "equivalent RMS current" as mentioned below, and select the motor so that this RMS current will not exceed the rated current of the motor.

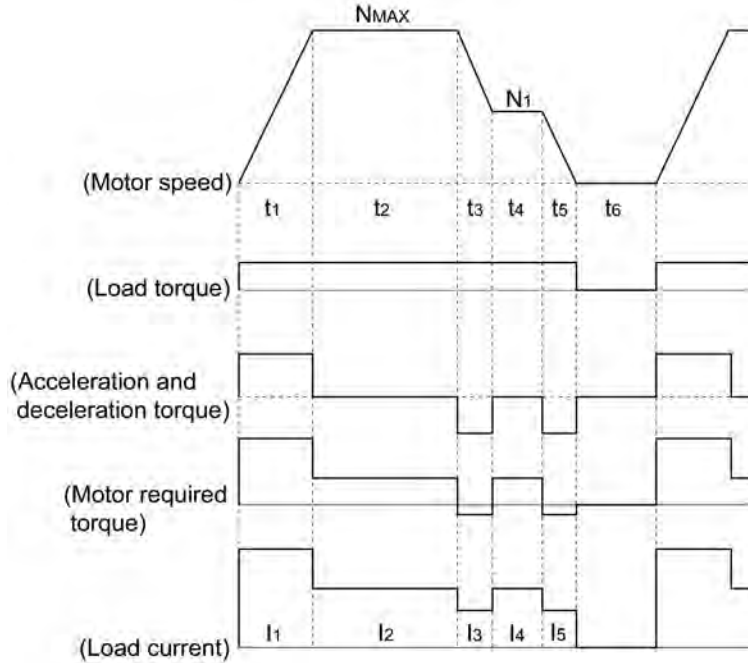

Figure 7.10 Sample of the Repetitive Operation

First, calculate the required torque of each part based on the speed pattern. Then using the torque-current curve of the motor, convert the torque to the motor current. The "equivalent RMS current, I_{eq} " can be finally calculated by the following equation:

$$I_{eq} = \sqrt{\frac{I_1^2 \cdot t_1 + I_2^2 \cdot t_2 + I_3^2 \cdot t_3 + I_4^2 \cdot t_4 + I_5^2 \cdot t_5}{t_1 + t_2 + t_3 + t_4 + t_5 + t_6}} \quad (A) \quad (7.15)$$

The torque-current curve for the dedicated motor is not available for actual calculation. Therefore, calculate the motor current I from the load torque τ_1 using the following equation (7.16). Then, calculate the equivalent current I_{eq} :

$$I = \sqrt{\left(\frac{\tau_1}{100} \times I_{t100}\right)^2 + I_{m100}^2} \quad (A) \quad (7.16)$$

Where, τ_1 is the load torque (%), I_{t100} is the torque current, and I_{m100} is exciting current.

7.2 Selecting a Braking Resistor

7.2.1 Selection procedure

The following three requirements must be satisfied simultaneously:

- 1) The maximum braking torque should not exceed values listed in Tables 6.6 to 6.8 in Chapter 6, Section 6.4.1 [1] "Braking resistors." To use the maximum braking torque exceeding values in those tables, select the braking resistor having one class larger capacity.
- 2) The discharge energy for a single braking action should not exceed the discharging capability (kW) listed in Tables 6.6 to 6.8 in Chapter 6, Section 6.4.1 [1] "Braking resistors." For detailed calculation, refer to Section 7.1.3.3 "Heat energy calculation of braking resistor."
- 3) The average loss that is calculated by dividing the discharge energy by the cyclic period must not exceed the average loss (kW) listed in Tables 6.6 to 6.8 in Chapter 6, Section 6.4.1 [1] "Braking resistors."

7.2.2 Notes on selection

The braking time T_1 , cyclic period T_0 , and duty cycle %ED are converted under deceleration braking conditions based on the rated torque as shown below. However, you do not need to consider these values when selecting the braking resistor capacity.

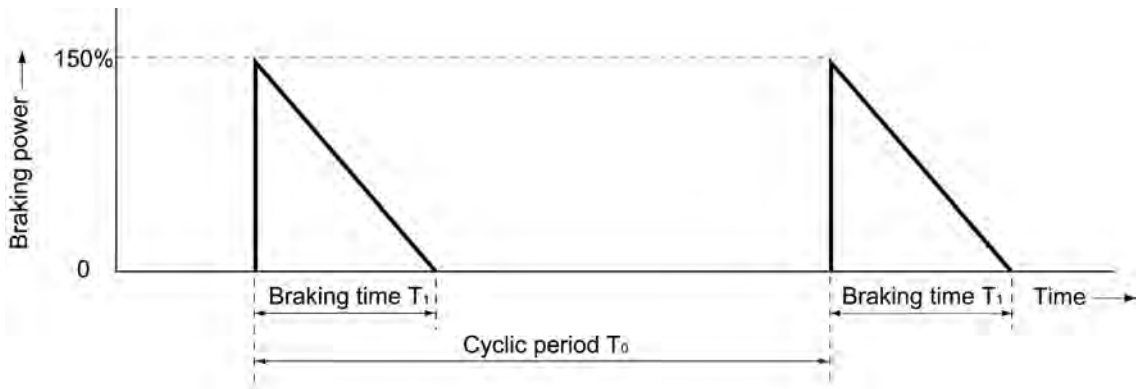

Figure 7.11 Duty Cycle

Part 5 Specifications



Chapter 8 SPECIFICATIONS

Chapter 9 FUNCTION CODES

Chapter 8

SPECIFICATIONS

This chapter describes specifications of the output ratings, control system, and terminal functions for the FRENIC-Multi series of inverters. It also provides descriptions of the operating and storage environment, external dimensions, examples of basic connection diagrams, and details of the protective functions.

Contents

8.1	Standard Models	8-1
8.1.1	Three-phase 230 V	8-1
8.1.2	Three-phase 460 V	8-2
8.1.3	Single-phase 230 V	8-3
8.2	Common Specifications	8-4
8.3	Terminal Specifications.....	8-8
8.3.1	Terminal functions	8-8
8.3.2	Terminal arrangement diagram and screw specifications.....	8-19
8.3.2.1	Main circuit terminals	8-19
8.3.2.2	Control circuit terminals.....	8-20
8.4	Operating Environment and Storage Environment	8-21
8.4.1	Operating environment.....	8-21
8.4.2	Storage environment	8-22
8.4.2.1	Temporary storage.....	8-22
8.4.2.2	Long-term storage	8-22
8.5	External Dimensions.....	8-23
8.5.1	Standard models	8-23
8.5.2	Standard keypad.....	8-26
8.6	Connection Diagrams.....	8-27
8.6.1	Running the inverter with keypad	8-27
8.6.2	Running the inverter by terminal commands	8-28
8.7	Protective Functions.....	8-30

8.1 Standard Models

8.1.1 Three-phase 230 V

Item		Specifications													
Type (FRN__E1S-2U)		F12	F25	F50	001	002	003	005	007	010	015	020			
Nominal applied motor (HP)		*1	1/8	1/4	1/2	1	2	3	5	7.5	10	15	20		
Output ratings	Rated capacity (kVA)	*2	0.3	0.6	1.2	2.0	3.2	4.4	6.8	10	13	19	24		
	Rated voltage (V)	*3	Three-phase 200 to 240 V (with AVR function)												
	Rated current (A)	*4	0.8 (0.7)	1.5 (1.4)	3.0 (2.5)	5.0 (4.2)	8.0 (7.0)	11 (10)	17 (16.5)	25 (23.5)	33 (31)	47 (44)	60 (57)		
	Overload capability		150% of rated current for 1 min, 200% - 0.5 s												
	Rated frequency (Hz)		50, 60 Hz												
Input power	Phases, voltage, frequency		Three-phase, 200 to 240 V, 50/60 Hz												
	Voltage/frequency variations		Voltage: +10 to -15% (Voltage unbalance: 2% or less) ^{*9} , Frequency: +5 to -5%												
	Rated current (A)	*5	(with DCR)		0.57	0.93	1.6	3.0	5.7	8.3	14.0	21.1	28.8	42.2	57.6
			(without DCR)		1.1	1.8	3.1	5.3	9.5	13.2	22.2	31.5	42.7	60.7	80.1
Required power supply capacity (kVA)	*6	0.2	0.3	0.6	1.1	2.0	2.9	4.9	7.4	10	15	20			
Braking	Torque (%)	*7	150		100		70	40		20					
	Torque (%)	*8	150												
	DC braking		Starting frequency: 0.1 to 60.0 Hz, Braking time: 0.0 to 30.0 s, Braking level: 0 to 100% of rated current												
	Braking transistor		Built-in												
Applicable safety standards			UL508C, C22.2 No.14, EN50178:1997												
Enclosure (IEC60529)			IP20, UL open type												
Cooling method			Natural cooling					Fan cooling							
Weight / Mass (lbs (kg))			1.3 (0.6)	1.3 (0.6)	1.5 (0.7)	1.8 (0.8)	3.7 (1.7)	3.7 (1.7)	5.1 (2.3)	7.5 (3.4)	7.9 (3.6)	13.5 (6.1)	15.7 (7.1)		

*1 Fuji 4-pole standard motor

*2 Rated capacity is calculated assuming the output rated voltage as 230 V.

*3 Output voltage cannot exceed the power supply voltage.

*4 Use the inverter at the current enclosed with parentheses () or below when the carrier frequency is set to 4 kHz or above (F26) and the inverter continuously runs at 100% load.

*5 The value is calculated assuming that the inverter is connected with a power supply with the capacity of 500 kVA (or 10 times the inverter capacity if the inverter capacity exceeds 50 kVA) and %X is 5%.

*6 Obtained when a DC reactor (DCR) is used.

*7 Average braking torque obtained when reducing the speed from 60 Hz with AVR control OFF. (It varies with the efficiency of the motor.)

*8 Average braking torque obtained by use of an external braking resistor (standard type available as option)

*9
$$\text{Voltage unbalance (\%)} = \frac{\text{Max voltage (V)} - \text{Min voltage (V)}}{\text{Three - phase average voltage (V)}} \times 67 \text{ (IEC 61800 - 3)}$$

If this value is 2 to 3%, use an optional AC reactor (ACR).

8.1.2 Three-phase 460 V

Item		Specifications										
Type (FRN___E1S-4U)		F50	001	002	003	005	007	010	015	020		
Nominal applied motor (HP)	*1	1/2	1	2	3	5	7.5	10	15	20		
Output ratings	Rated capacity (kVA)	*2	1.2	2.0	2.9	4.4	7.2	10	14	19	24	
	Rated voltage (V)	*3	Three-phase 380 to 480 V (with AVR function)									
	Rated current (A)	*4	1.5	2.5	3.7	5.5	9.0	13	18	24	30	
	Overload capability		150% of rated current for 1 min, 200% - 0.5 s									
	Rated frequency (Hz)		50, 60 Hz									
Input power	Phases, voltage, frequency		Three-phase, 380 to 480 V, 50/60 Hz									
	Voltage/frequency variations		Voltage: +10 to -15% (Voltage unbalance: 2% or less) ^{*9} , Frequency: +5 to -5%									
	Rated current (A)	*5	(with DCR)	0.85	1.6	3.0	4.4	7.3	10.6	14.4	21.1	28.8
			(without DCR)	1.7	3.1	5.9	8.2	13.0	17.3	23.2	33.0	43.8
Required power supply capacity (kVA)	*6	0.6	1.1	2.0	2.9	4.9	7.4	10	15	20		
Braking	Torque (%)	*7	100		70	40		20				
	Torque (%)	*8	150									
	DC braking		Starting frequency: 0.1 to 60.0 Hz, Braking time: 0.0 to 30.0 s, Braking level: 0 to 100% of rated current									
	Braking transistor		Built-in									
Applicable safety standards		UL508C, C22.2 No.14, EN50178:1997										
Enclosure (IEC60529)		IP20, UL open type										
Cooling method		Natural cooling			Fan cooling							
Weight / Mass (lbs (kg))		2.4 (1.1)	2.6 (1.2)	3.7 (1.7)	3.7 (1.7)	5.1 (2.3)	7.5 (3.4)	7.9 (3.6)	13.5 (6.1)	15.7 (7.1)		

*1 Fuji 4-pole standard motor

*2 Rated capacity is calculated by assuming the output rated voltage as 460 V.

*3 Output voltage cannot exceed the power supply voltage.

*4 Use the inverter at the current enclosed with parentheses () or below when the carrier frequency is set to 4 kHz or above (F26) and the inverter continuously runs at 100% load.

*5 The value is calculated assuming that the inverter is connected with a power supply with the capacity of 500 kVA (or 10 times the inverter capacity if the inverter capacity exceeds 50 kVA) and %X is 5%.

*6 Obtained when a DC reactor (DCR) is used.

*7 Average braking torque obtained when reducing the speed from 60 Hz with AVR control OFF. (It varies with the efficiency of the motor.)

*8 Average braking torque obtained by use of an external braking resistor (standard type available as option)

*9
$$\text{Voltage unbalance (\%)} = \frac{\text{Max voltage (V)} - \text{Min voltage (V)}}{\text{Three - phase average voltage (V)}} \times 67 \text{ (IEC 61800 - 3)}$$

If this value is 2 to 3%, use an optional AC reactor (ACR).

8.1.3 Single-phase 230 V

Item		Specifications						
Type (FRN___E1S-7U)		F12	F25	F50	001	002	003	
Nominal applied motor (HP)	*1	1/8	1/4	1/2	1	2	3	
Output ratings	Rated capacity (kVA)	*2	0.3	0.6	1.2	2.0	3.2	4.4
	Rated voltage (V)	*3	Three-phase 200 to 240 V (with AVR function)					
	Rated current (A)	*4	0.8 (0.7)	1.5 (1.4)	3.0 (2.5)	5.0 (4.2)	8.0 (7.0)	11 (10)
	Overload capability		150% of rated current for 1 min, 200% - 0.5 s					
	Rated frequency (Hz)		50, 60 Hz					
Input power	Phases, voltage, frequency		Single-phase, 200 to 240 V, 50/60 Hz					
	Voltage/frequency variations		Voltage: +10 to -10%, Frequency: +5 to -5%					
	Rated current (A)	*5	(with DCR) 1.1	2.0	3.5	6.4	11.6	17.5
			(without DCR) 1.8	3.3	5.4	9.7	16.4	24.8
Required power supply capacity (kVA)	*6	0.3	0.4	0.7	1.3	2.4	3.5	
Braking	Torque (%)	*7	150		100		70	40
	Torque (%)	*8	150					
	DC braking		Starting frequency: 0.1 to 60.0 Hz, Braking level: 0 to 100% of rated current, Braking time: 0.0 to 30.0 s					
	Braking transistor		Built-in					
Applicable safety standards		UL508C, C22.2 No.14, EN50178:1997						
Enclosure (IEC60529)		IP20, UL open type						
Cooling method		Natural cooling				Fan cooling		
Weight / Mass (lbs (kg))		1.3 (0.6)	1.3 (0.6)	1.5 (0.7)	2.0 (0.9)	4.0 (1.8)	5.3 (2.4)	

*1 Fuji 4-pole standard motor

*2 Rated capacity is calculated by assuming the output rated voltage as 230 V.

*3 Output voltage cannot exceed the power supply voltage.

*4 Use the inverter at the current enclosed with parentheses () or below when the carrier frequency is set to 4 kHz or above (F26) and the inverter continuously runs at 100% load.





*5 The value is calculated assuming that the inverter is connected with a power supply with the capacity of 500 kVA (or 10 times the inverter capacity if the inverter capacity exceeds 50 kVA) and %X is 5%.

*6 Obtained when a DC reactor (DCR) is used.

*7 Average braking torque obtained when reducing the speed from 60 Hz with AVR control OFF. (It varies with the efficiency of the motor.)

*8 Average braking torque obtained by use of an external braking resistor (standard type available as option)

8.2 Common Specifications

Item		Explanation	Remarks
Output frequency	Setting range	Maximum frequency	25 to 400 Hz
		Base frequency	25 to 400 Hz
		Starting frequency	0.1 to 60.0 Hz, Duration: 0.0 to 10.0 s
		Carrier frequency	<ul style="list-style-type: none"> 0.75 to 15 kHz <p>Note: When the carrier frequency is set at 6 kHz or above, it may automatically drop depending upon the ambient temperature or output current to protect the inverter. (Automatic carrier frequency reduction/stop function available)</p> <ul style="list-style-type: none"> Carrier frequency modulation with spread spectrum for noise reduction
	Accuracy (Stability)	<ul style="list-style-type: none"> Analog setting: $\pm 0.2\%$ of maximum frequency (at 25 ± 10 °C (77 ± 50 °F)) Digital setting: $\pm 0.01\%$ of maximum frequency (at -10 to $+50$ °C (14 to 122 °F)) 	
Setting resolution	<ul style="list-style-type: none"> Analog setting: 1/3000 of maximum frequency (ex. 0.02 Hz at 60 Hz, 0.04 Hz at 120 Hz) Digital setting: 0.01 Hz (99.99 Hz or less), 0.1 Hz (100.0 Hz or more) Link setting: Selectable from 2 types <ul style="list-style-type: none"> 1/20000 of maximum frequency (ex. 0.003 Hz at 60 Hz, 0.006 Hz at 120 Hz) 0.01 Hz (fixed) 		
Control	Control method	<ul style="list-style-type: none"> V/f control Dynamic torque-vector control V/f control (with sensor, when the optional pulse generator (PG) interface card is installed) 	
	V/f characteristic	230 V	Possible to set output voltage at base frequency and at maximum output frequency (+80 to +240 V). The AVR control can be turned ON or OFF.
			Non-linear V/f setting (2 points): Desired voltage (0 to +240 V) and frequency (0 to 400 Hz) can be set.
		460 V	Possible to set output voltage at base frequency and at maximum output frequency (+160 to +500 V). The AVR control can be turned ON or OFF.
			Non-linear V/f setting (2 points): Desired voltage (0 to +500 V) and frequency (0 to 400 Hz) can be set.
	Torque boost	<ul style="list-style-type: none"> Auto torque boost (for constant torque load) Manual torque boost: Desired torque boost (0.0 to 20.0%) can be set. Select application load with the function code F37/A13. (Variable torque load or constant torque load) 	
Starting torque	200% or over (Reference frequency: 0.5 Hz with slip compensation and auto torque boost)		
Start/stop operation	Keypad: Start and stop with  and  keys (standard keypad) Start and stop with  ,  , and  keys (optional multi-function keypad)		
	External signals (digital inputs): Forward (Reverse) rotation, stop command (capable of 3-wire operation), coast-to-stop command, external alarm, alarm reset, etc.		
	Link operation: Operation through RS-485 or field bus (option) communications		
	Switching operation command: Link switching		

Item	Explanation	Remarks	
Control	Frequency command	<p>Keypad: ⏶ and ⏷ keys (with data protection function)</p> <p>Analog input: Analog input can be set with external voltage/current input</p> <ul style="list-style-type: none"> • 0 to ± 10 VDC/0 to ± 100% (terminals [12], [C1] (V2 function)) • +4 to +20 mA DC/0 to 100% (terminal [C1]) <p>Note: Terminal [C1] can be switched to input 0 to 10 VDC/0 to 100% (V2 function).</p> <p>Multi-frequency: Selectable from 16 different of frequencies (0 to 15)</p> <p>UP/DOWN operation: Frequency can be increased or decreased while the digital input signal is ON.</p> <p>Link operation: Frequency can be specified via the RS-485 or field bus communications port (option).</p> <p>Frequency switching: Two types of frequency settings can be switched with an external signal (digital input). Changeover between frequency setting and multi-frequency setting via communication is available.</p> <p>Auxiliary frequency setting: Inputs at terminal [12] or [C1] (C1/V2 function) can be added to the main setting as auxiliary frequency settings.</p> <p>Inverse operation: Normal/inverse operation can be set or switched with digital input signal and function code setting.</p> <ul style="list-style-type: none"> • +10 to 0 VDC/0 to 100% at terminal [12] and [C1] (V2 function) • +20 to +4 mA DC/0 to 100% at terminal [C1] (C1 function) <p>Pulse train input: Max. 30 kHz/Maximum output frequency (when the optional PG interface card is installed.)</p>	
	Acceleration/ deceleration time	<ul style="list-style-type: none"> • 0.00 to 3600 s variable setting • Acceleration and deceleration time can be independently set with 2 types and selected with digital input signal (1 point). • Acceleration and deceleration pattern can be selected from 4 types: Linear, S-curve (weak), S-curve (strong), Curvilinear (constant output maximum capacity) • Shutoff of the run command lets the motor coast to a stop. • Deceleration time exclusively applied to the "force to stop" command STOP can be specified (setting range: 0.00 to 3600 s). This setting automatically cancels the S-curve setting. • Acceleration/deceleration time during jogging operation can be set. (Setting range: 0.00 to 3600 s) 	
	Frequency limiter (Upper limit and lower limit frequencies)	Specifies the high and low limits in Hz. (Setting range: 0 to 400 Hz)	
	Bias	Bias of reference frequency and PID command can be independently set (setting range: 0 to ±100%).	
	Gain	Analog input gain can be set between 0 and 200%.	
	Jump frequency	Three operation points and their common jump width (0 to 30.0 Hz) can be set.	
	Timer operation	The inverter operates and stops for the time set with the keypad (1-cycle operation).	
	Jogging operation	<p>⏶ key (standard keypad), ⏶/⏷ keys (optional multi-function keypad), or digital input signals</p> <p>The acceleration and deceleration times dedicated for jogging can be set and they are common.</p>	
	Auto-restart after momentary power failure	<ul style="list-style-type: none"> • Restarts the inverter without stopping the motor after momentary power failure. • Restart at 0 Hz, restart from the frequency used before momentary power failure can be selected. • Motor speed at restart can be searched and restarted. 	
	Hardware current limiter	Limits the current by hardware to prevent an overcurrent trip from being caused by fast load variation or momentary power failure, which cannot be covered by the software current limiter. This limiter can be canceled.	

Item	Explanation	Remarks
Slip compensation	<ul style="list-style-type: none"> Compensates for decrease in speed according to the load, enabling stable operation. Time constant can be changed. Possible to enable or disable slip compensation during acceleration/deceleration or in constant output range. 	
Droop control	Decrease the speed according to the load torque.	
Torque limiter	<ul style="list-style-type: none"> Controls the output torque lower than the set limit value. Can be switched to the second torque limit with digital input signal. Soft start (filter function) is available when switching the torque control to 1/2. 	
Software current limiter	Keeps the current under the preset value during operation by software.	
Overload stop	Detects torque or current. If the detected value exceeds the preset one, this function stops the motor in any of the following modes--"decelerate to stop," "coast to a stop" and "hit mechanical stop" according to the function code J65 data.	
PID control	PID process control and PID dancer control are available. <ul style="list-style-type: none"> Process command: Keypad, analog input (terminals [12] and [C1]) and RS-485 communications Feedback value: Analog input (terminals [12] and [C1]) Alarm output (absolute value alarm, deviation alarm) Normal operation/inverse operation • Anti-reset windup function PID output limiter • Integration reset/hold 	
	Speed control (slip compensation, A phase and B phase/B phase) (When the optional PG interface card is installed.)	
Auto search for idling motor speed	The inverter automatically searches the idling motor speed to be harmonized and starts to drive it without stopping it.	
Automatic deceleration	When the torque calculation value exceeds the limit level set for the inverter during deceleration, the output frequency is automatically controlled and the deceleration time automatically extends to avoid an \overline{UL} trip.	
Deceleration characteristic (improving braking ability)	The motor loss increases during deceleration to reduce the load energy regenerating at the inverter to avoid an \overline{UL} trip upon mode selection.	
Auto energy saving operation	The output voltage is controlled to minimize the total sum of the motor loss and inverter loss at a constant speed.	
Overload prevention Control	The output frequency is automatically reduced to suppress the overload protection trip of inverter caused by an increase in the ambient temperature, operation frequency, motor load or the like.	
Auto-tuning	Automatically tunes the motor for $r1$, $X\sigma$, excitation current, and slip frequency ($r2$).	
Cooling fan ON/OFF control	Detects inverter internal temperature and stops cooling fan when the temperature is low.	
Secondary motor setting	<ul style="list-style-type: none"> One inverter can be used to control two motors by switching (switching is not available while a motor is running). Base frequency, rated current, torque boost, electronic thermal, and slip compensation can be set as data for the secondary motor. The second motor constants can be set in the inverter. (Auto-tuning possible) 	
Universal DI	The presence of digital signal in a device externally connected to the set terminal can be sent to the master controller.	
Universal AO	The output from the master controller can be output from the terminal [FM].	
Speed control	The motor speed can be detected with the pulse encoder and speed can be controlled. (When the optional PG interface card is installed.)	
Positioning control	Only one program can be executed by setting the number of pulses to the stop position and deceleration point. (When the optional PG interface card is installed.)	
Rotation direction control	Select either of reverse or forward rotation prevention.	

	Item	Explanations	Remarks
Indication	Running/stopping	Speed monitor, output current (A), output voltage (V), torque calculation value, input power (kW), PID command, PID feedback amount, PID output, load factor, motor output, period for timer operation (s) Select the speed monitor to be displayed from the following: <ul style="list-style-type: none"> Reference frequency (Hz) Output frequency 1 (before slip compensation) (Hz) Output frequency 2 (after slip compensation) (Hz) Motor speed (set value) (r/min) Load shaft speed (set value) (r/min) Line speed (set value) (m/min) Constant feeding rate time (set value) (min) Constant feeding rate time (running) (min) 	
	Life early warning	The life early warning of the main circuit capacitors, capacitors on the PC boards and the cooling fan can be displayed. An external output is issued in a transistor output signal.	
	Cumulative run time	Shows the cumulative running hours of the motor and inverter.	
	I/O check	Displays the input/output signal status of the inverter.	
	Power monitor	Displays input power (momentary), accumulated power, electricity cost (accumulated power x displayed coefficient).	
	Trip error code	Displays the cause of trip by codes. <ul style="list-style-type: none"> <i>OL 1</i> Motor 1 overload <i>OL 2</i> Motor 2 overload <i>OL 3</i> Overcurrent during acceleration <i>OL 4</i> Overcurrent during deceleration <i>OL 5</i> Overcurrent at constant speed <i>Er 1</i> Memory error <i>Er 2</i> Keypad communication error <i>Er 3</i> CPU error <i>Er 4</i> Optional communication error <i>Er 5</i> Option error <i>Er 6</i> Operation error <i>Er 7</i> Tuning error <i>Er 8</i> RS-485 communication error <i>Er F</i> Data save error due to undervoltage <i>Er P</i> RS-485 communication error (option) <i>Er H</i> Hardware error <i>Er r</i> Mock alarm <i>L 1</i> Input phase loss <i>LU</i> Undervoltage <i>OP</i> Output phase loss <i>OU 1</i> Overvoltage during acceleration <i>OU 2</i> Overvoltage during deceleration <i>OU 3</i> Overvoltage at constant speed <i>OH 1</i> Overheating of the heat sink <i>OH 2</i> External alarm <i>OH 3</i> Inverter overheat <i>OH 4</i> Motor protection (PTC thermistor) <i>ObH</i> Overheating of braking resistor <i>PG</i> PG disconnection 	
	Running or trip mode	Trip history: Saves and displays the last 4 trip factors and their detailed description.	
Protection	Refer to Section 8.7 "Protective Functions."		
Environment	Refer to Section 8.4 "Operating Environment and Storage Environment."		

8.3 Terminal Specifications

8.3.1 Terminal functions

Main circuit and analog input terminals

Classification	Symbol	Name	Functions
Main circuit	L1/R, L2/S, L3/T or L1/L, L2/N	Main circuit power inputs	Connect the three-phase input power lines, or single-phase input power lines.
	U, V, W	Inverter outputs	Connect a three-phase motor.
	P1, P(+)	DC reactor connection	Connect a DC reactor (DCR) for correcting power factor.
	P(+), DB	Braking resistor	Connect the braking resistor (option).
	P(+), N(-)	DC link bus	Connect a DC link bus of other inverter(s). An optional regenerative converter is also connectable to these terminals.
	 G	Grounding for inverter and motor	Grounding terminals for the inverter's chassis (or case) and motor. Earth one of the terminals and connect the grounding terminal of the motor. Inverters provide a pair of grounding terminals that function equivalently.
Analog input	[13]	Power supply for the potentiometer	Power supply (+10 VDC) for frequency command potentiometer (Potentiometer: 1 to 5kΩ) The potentiometer of 1/2 W rating or more should be connected.
	[12]	Analog setting voltage input	(1) The frequency is commanded according to the external analog input voltage. <ul style="list-style-type: none"> • 0 to ±10 VDC/0 to ±100% (Normal operation) • ±10 to 0 VDC/0 to ±100% (Inverse operation) (2) Inputs setting signal (PID command value) or feedback signal. (3) Used as additional auxiliary setting to various frequency settings. <ul style="list-style-type: none"> • Input impedance: 22kΩ • The maximum input is ±15 VDC, however, the current larger than ±10 VDC is handled as ±10 VDC. Note: Inputting a bipolar analog voltage (0 to ±10 VDC) to terminal [12] requires setting function code C35 to "0."

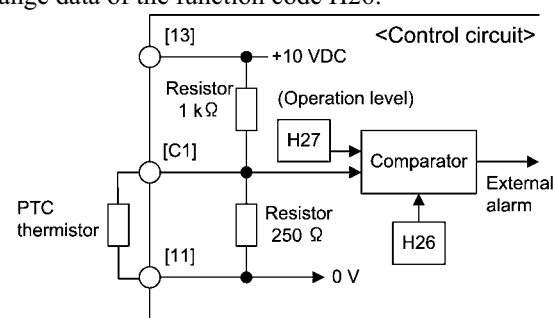
Classifi- cation	Symbol	Name	Functions
Analog input	[C1]	Analog setting current input (C1 function)	(1) The frequency is commanded according to the external analog input current. <ul style="list-style-type: none"> • 4 to 20 mA DC/0 to 100% (Normal operation) • 20 to 4 mA DC/0 to 100 % (Inverse operation) (2) Inputs setting signal (PID process command value) or feedback signal. (3) Used as additional auxiliary setting to various frequency settings. <ul style="list-style-type: none"> • Input impedance: 250Ω • Maximum input is +30 mA DC, however, the current larger than +20 mA DC is handled as +20 mA DC.
		Analog setting voltage input (V2 function)	(1) The frequency is commanded according to the external analog input voltage. <ul style="list-style-type: none"> • 0 to +10 VDC/0 to +100 % (Normal operation) • +10 to 0 VDC/0 to +100 % (Inverse operation) (2) Inputs setting signal (PID process command value) or feedback signal. (3) Used as additional auxiliary setting to various frequency settings. <ul style="list-style-type: none"> • Input impedance: 22 kΩ • Maximum input is +15 VDC, however, the voltage larger than +10 VDC is handled as +10 VDC.
		PTC thermistor input (PTC function)	(1) Connects PTC (Positive Temperature Coefficient) thermistor for motor protection. The figure shown below illustrates the internal circuit diagram. To use the PTC thermistor, you must change data of the function code H26.
			 <p style="text-align: center;">Figure 8.1 Internal Circuit Diagram</p>
	[11]	Analog common	Common for analog input/output signals ([13], [12], [C1], and [FM]) Isolated from terminals [CM]s and [CMY].



Classification	Symbol	Name	Functions	Related function codes
Analog input	<p>Note</p> <ul style="list-style-type: none"> - Since low level analog signals are handled, these signals are especially susceptible to the external noise effects. Route the wiring as short as possible (within 66 ft (20 m)) and use shielded wires. In principle, ground the shielded sheath of wires; if effects of external inductive noises are considerable, connection to terminal [11] may be effective. As shown in Figure 8.2, ground the single end of the shield to enhance the shield effect. - Use a twin contact relay for low level signals if the relay is used in the control circuit. Do not connect the relay's contact to terminal [11]. - When the inverter is connected to an external device outputting the analog signal, a malfunction may be caused by electric noise generated by the inverter. If this happens, according to the circumstances, connect a ferrite core (a toroidal core or an equivalent) to the device outputting the analog signal and/or connect a capacitor having the good cut-off characteristics for high frequency between control signal wires as shown in Figure 8.3. - Do not apply a voltage of +7.5 VDC or higher to terminal [C1] when you assign the terminal [C1] to C1 function. Doing so could damage the internal control circuit. 			
	<p>Figure 8.2 Connection of Shielded Wire</p>	<p>Figure 8.3 Example of Electric Noise Reduction</p>		

Digital Input Terminals

Classification	Symbol	Name	Functions
Digital input	[X1]	Digital input 1	<p>(1) Various signals such as coast-to-stop, alarm from external equipment, and multi-frequency commands can be assigned to terminals [X1] to [X5], [FWD] and [REV] by setting function codes E01 to E05, E98, and E99. For details, refer to Chapter 9, Section 9.2 "Overview of Function Codes."</p> <p>(2) Input mode, i.e. SINK/SOURCE, is changeable by using the internal slide switch. (Refer to "Setting up the slide switches" on page 8-17.)</p> <p>(3) Switches the logic value (1/0) for ON/OFF of the terminals [X1] to [X5], [FWD], or [REV]. If the logic value for ON of the terminal [X1] is 1 in the normal logic system, for example, OFF is 1 in the negative logic system and vice versa.</p> <p>(4) The negative logic system never applies to the terminals assigned for FWD and REV.</p> <p>(Digital input circuit specifications)</p>
	[X2]	Digital input 2	
	[X3]	Digital input 3	
	[X4]	Digital input 4	
	[X5]	Digital input 5	
	[FWD]	Run forward command	
	[REV]	Run reverse command	
[PLC]	PLC signal power	<p>Connects to PLC output signal power supply. (Rated voltage: +24 VDC (Maximum 50 mA DC): Allowable range: +22 to +27 VDC)</p> <p>This terminal also supplies a power to the circuitry connected to the transistor output terminals [Y1] and [Y2]. Refer to "<u>Analog output, pulse output, transistor output, and relay output terminals</u>" in this Section for more.</p>	
[CM]	Digital input common	<p>Two common terminals for digital input signals</p> <p>These terminals are electrically isolated from the terminals [11]s and [CMY].</p>	

Figure 8.4 Digital Input Circuit

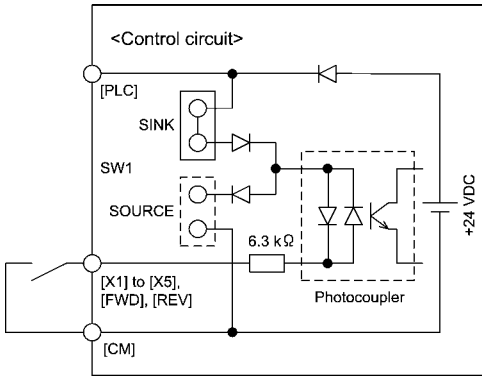
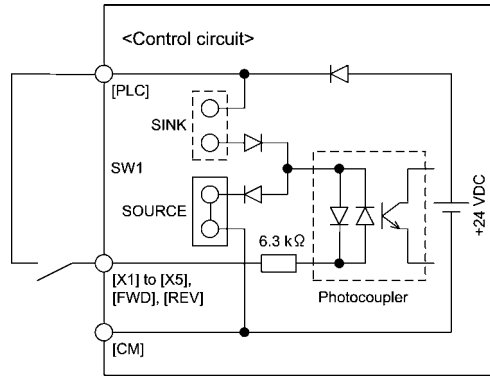
Item	Min.	Max.
Operation voltage (SINK)	ON level	0 V
	OFF level	22 V
Operation voltage (SOURCE)	ON level	22 V
	OFF level	0 V
Operation current at ON (Input voltage is at 0 V)	2.5 mA	5 mA
Allowable leakage current at OFF	-	0.5 mA

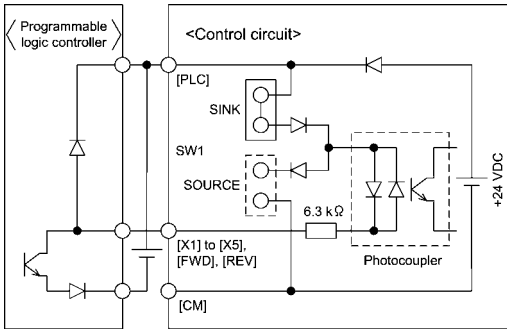
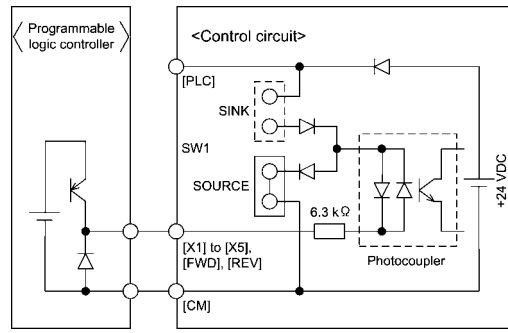
Classification	Symbol	Name	Functions
		<p>■ Using a relay contact to turn [X1], [X2], [X3], [X4], [X5], [FWD], or [REV] ON or OFF</p>	<p>Figure 8.5 shows two examples of a circuit that uses a relay contact to turn control signal input [X1], [X2], [X3], [X4], [X5], [FWD], or [REV] ON or OFF. In circuit (a), the slide switch SW1 has been turned to SINK, whereas in circuit (b) it has been turned to SOURCE.</p> <p>Note: To configure this kind of circuit, use a highly reliable relay. (Recommended product: Fuji control relay Model HH54PW)</p>
		 <p>(a) With the switch turned to SINK</p>	 <p>(b) With the switch turned to SOURCE</p>
Digital input		<p>■ Using a programmable logic controller (PLC) to turn [X1], [X2], [X3], [X4], [X5], [FWD], or [REV] ON or OFF</p>	<p>Figure 8.6 shows two examples of a circuit that uses a programmable logic controller (PLC) to turn control signal input [X1], [X2], [X3], [X4], [X5], [FWD], or [REV] ON or OFF. In circuit (a), the slide switch SW1 has been turned to SINK, whereas in circuit (b) it has been turned to SOURCE.</p> <p>In circuit (a) below, short-circuiting or opening the transistor's open collector circuit in the PLC using an external power source turns ON or OFF control signal [X1], [X2], [X3], [X4], [X5], [FWD], or [REV]. When using this type of circuit, observe the following:</p> <ul style="list-style-type: none"> - Connect the + node of the external power source (which should be isolated from the PLC's power) to terminal [PLC] of the inverter. - Do not connect terminal [CM] of the inverter to the common terminal of the PLC.
		 <p>(a) With the switch turned to SINK</p>	 <p>(b) With the switch turned to SOURCE</p>
		<p>Figure 8.6 Circuit Configuration Using a PLC</p>	<p>For details about the slide switch setting, refer to "Setting up the slide switches" on page 8-17.)</p>

Analog output, pulse output, transistor output, and relay output terminals

Classification	Symbol	Name	Functions
Analog output	[FM]	Analog monitor (FMA function)	<p>The monitor signal for analog DC voltage (0 to +10 V) is output. You can select FMA function with slide switch SW6 on the interface PCB, and change the data of the function code F29.</p> <p>You can also select the signal functions following with function code F31.</p> <ul style="list-style-type: none"> • Output frequency 1 (Before slip compensation) • Output frequency 2 (After slip compensation) • Output current • Output torque • Input power • PG feedback value • Universal AO • Calibration • PID output (MV) • Output voltage • Load factor • PID feedback amount (PV) • DC link bus voltage • Motor output • PID command (SV) <p>* Input impedance of external device: Min. $5k\Omega$ (0 to +10 VDC output)</p> <p>* While the terminal is outputting 0 to +10 VDC, it is capable to drive up to two meters with $10k\Omega$ impedance. (Adjustable range of the gain: 0 to 300%)</p>
	Pulse output		Pulse monitor (FMP function)
		[11]	Analog common

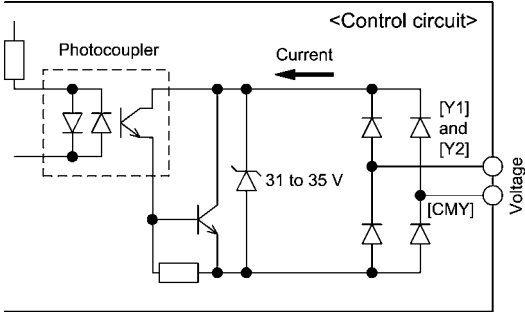
Classification	Symbol	Name	Functions														
Transistor output	[Y1]	Transistor output 1	<p>(1) Various signals such as inverter running, speed/freq. arrival and overload early warning can be assigned to any terminals, [Y1] and [Y2] by setting function code E20 and E21. Refer to Chapter 9, Section 9.2 "Overview of Function Codes" for details.</p> <p>(2) Switches the logic value (1/0) for ON/OFF of the terminals between [Y1], [Y2], and [CMY]. If the logic value for ON between [Y1], [Y2], and [CMY] is 1 in the normal logic system, for example, OFF is 1 in the negative logic system and vice versa.</p> <p>(Transistor output circuit specifications)</p>  <p>Figure 8.7 Transistor Output Circuit</p> <table border="1" data-bbox="784 1047 1221 1335"> <thead> <tr> <th colspan="2">Item</th> <th>Max.</th> </tr> </thead> <tbody> <tr> <td rowspan="2">Operation voltage</td> <td>ON level</td> <td>3 V</td> </tr> <tr> <td>OFF level</td> <td>27 V</td> </tr> <tr> <td colspan="2">Maximum motor current at ON</td> <td>50 mA</td> </tr> <tr> <td colspan="2">Leakage current at OFF</td> <td>0.1 mA</td> </tr> </tbody> </table> <p>Figure 8.8 shows examples of connection between the control circuit and a PLC.</p> <p>Note</p> <ul style="list-style-type: none"> • When a transistor output drives a control relay, connect a surge-absorbing diode across relay's coil terminals. • When any equipment or device connected to the transistor output needs to be supplied with DC power, feed the power (+24 VDC: allowable range: +22 to +27 VDC, 50 mA max.) through the [PLC] terminal. Short-circuit between the terminals [CMY] and [CM] in this case. 	Item		Max.	Operation voltage	ON level	3 V	OFF level	27 V	Maximum motor current at ON		50 mA	Leakage current at OFF		0.1 mA
	Item			Max.													
	Operation voltage	ON level		3 V													
OFF level		27 V															
Maximum motor current at ON		50 mA															
Leakage current at OFF		0.1 mA															
[Y2]	Transistor output 2																
[CMY]	Transistor output common	<p>Common terminal for transistor output signal terminals</p> <p>This terminal is electrically isolated from terminals, [CM]s and [11]s.</p>															

Classification	Symbol	Name	Functions	Related function codes
Transistor output		<p>■ Connecting Programmable Logic Controller (PLC) to Terminal [Y1] or [Y2]</p> <p>Figure 8.8 shows two examples of circuit connection between the transistor output of the inverter's control circuit and a PLC. In example (a), the input circuit of the PLC serves as a SINK for the control circuit output, whereas in example (b), it serves as a SOURCE for the output.</p>	 <p>(a) PLC serving as SINK</p> <p>(b) PLC serving as SOURCE</p>	
	Relay output	[30A/B/C]	Alarm relay output (for any error)	<p>(1) Outputs a contact signal (SPDT) when a protective function has been activated to stop the motor. Contact rating: $250 \text{ VAC}, 0.3 \text{ A}, \cos \phi = 0.3, 48 \text{ VDC}, 0.5 \text{ A}$</p> <p>(2) Any one of output signals assigned to terminals [Y1] and [Y2] can also be assigned to this relay contact to use it for signal output.</p> <p>(3) Switching of the normal/negative logic output is applicable to the following two contact output modes: "Between terminals [30A] and [30C] is closed (excited) for ON signal output (Active ON)" or "Between terminals [30A] and [30C] is open (non-excited) for ON signal output (Active OFF)."</p>

Figure 8.8 Connecting PLC to Control Circuit

RS-485 communications port

Classification	Connector	Name	Functions
Communication	RJ-45 connector for the keypad	Standard RJ-45 connector	<p>(1) Used to connect the inverter with the keypad. The inverter supplies the power to the keypad through the pins specified below. The extension cable for remote operation also uses wires connected to these pins for supplying the keypad power.</p> <p>(2) Remove the keypad from the standard RJ-45 connector, and connect the RS-485 communications cable to control the inverter through the PC or PLC (Programmable Logic Controller). Refer to "Setting up the slide switches" on page 8-17 for setting of the terminating resistor.</p>
		 <p style="text-align: center;">Figure 8.9 RJ-45 Connector and its Pin Assignment*</p> <p>* Pins 1, 2, 7, and 8 are exclusively assigned to power lines for the standard keypad and multi-function keypad, so do not use those pins for any other equipment.</p>	

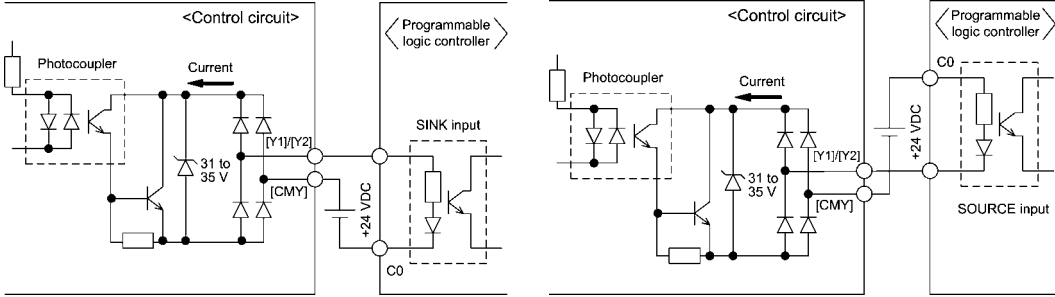
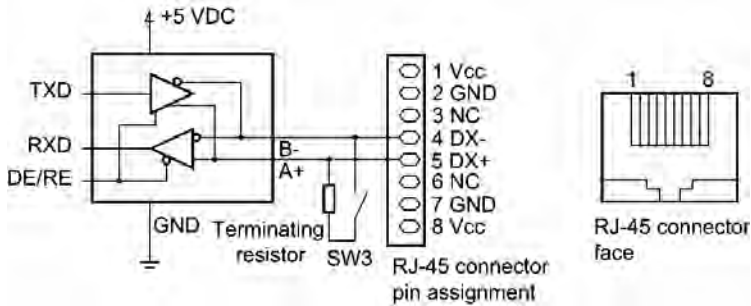

- Route the wiring of the control circuit terminals as far from the wiring of the main circuit as possible. Otherwise electric noise may cause malfunctions.
- Fix the control circuit wires inside the inverter to keep them away from the live parts of the main circuit (such as the terminal block of the main circuit).
- The RJ-45 connector pin assignment on the FRENIC-Multi series is different from that on the FVR-E11S series. Do not connect to the keypad of the FVR-E11S series of inverter. Doing so could damage the internal control circuit.

Setting up the slide switches

Switching the slide switches located on the control PCB and interface PCB allows you to customize the operation mode of the analog output terminals, digital I/O terminals, and communications ports. The locations of those switches are shown in Figure 8.10.

To access the slide switches, remove the terminal cover and keypad.

 For details on how to remove the terminal cover, refer to the FRENIC-Multi Instruction Manual, Chapter 2, Section 2.3.1, "Removing the terminal cover and the main circuit terminal block cover" and Chapter 1, Section 1.2, "External View and Terminal Blocks," Figure 1.4.

Table 8.1 lists the function of each slide switch.

Table 8.1 Function of Each Slide Switch

Slide Switch	Function																				
① SW1	<p>Switches the service mode of the digital input terminals between SINK and SOURCE.</p> <ul style="list-style-type: none"> To make the digital input terminal [X1] to [X5], [FWD] or [REV] serve as a current sink, turn SW1 to the SINK position. To make them serve as a current source, turn SW1 to the SOURCE position. <p>Factory default: SINK</p>																				
② SW3	<p>Switches the terminating resistor of RS-485 communications port on the inverter on and off.</p> <ul style="list-style-type: none"> To connect a keypad to the inverter, turn SW3 to OFF. (Factory default) If the inverter is connected to the RS-485 communications network as a terminating device, turn SW3 to ON. 																				
③ SW6	<p>Switches the output mode of the output terminal [FM] between analog voltage and pulse output.</p> <p>When changing this switch setting, also change the data of function code F29.</p> <table border="1" data-bbox="483 1081 1349 1268"> <thead> <tr> <th></th> <th>SW6</th> <th>Data for F29</th> </tr> </thead> <tbody> <tr> <td>Analog voltage output (Factory default)</td> <td>FMA</td> <td>0</td> </tr> <tr> <td>Pulse output</td> <td>FMP</td> <td>2</td> </tr> </tbody> </table>		SW6	Data for F29	Analog voltage output (Factory default)	FMA	0	Pulse output	FMP	2											
	SW6	Data for F29																			
Analog voltage output (Factory default)	FMA	0																			
Pulse output	FMP	2																			
④ SW7 SW8	<p>Switches property of the input terminal [C1] for C1, V2, or PTC.</p> <p>When changing this switch setting, also change the data of function code E59 and H26.</p> <table border="1" data-bbox="483 1392 1349 1661"> <thead> <tr> <th></th> <th>SW7</th> <th>SW8</th> <th>Data for E59</th> <th>Data for H26</th> </tr> </thead> <tbody> <tr> <td>Analog frequency setting in current (Factory default)</td> <td>C1</td> <td>OFF</td> <td>0</td> <td>0</td> </tr> <tr> <td>Analog frequency setting in voltage</td> <td>V2</td> <td>OFF</td> <td>1</td> <td>0</td> </tr> <tr> <td>PTC thermistor input</td> <td>C1</td> <td>ON</td> <td>0</td> <td>1</td> </tr> </tbody> </table>		SW7	SW8	Data for E59	Data for H26	Analog frequency setting in current (Factory default)	C1	OFF	0	0	Analog frequency setting in voltage	V2	OFF	1	0	PTC thermistor input	C1	ON	0	1
	SW7	SW8	Data for E59	Data for H26																	
Analog frequency setting in current (Factory default)	C1	OFF	0	0																	
Analog frequency setting in voltage	V2	OFF	1	0																	
PTC thermistor input	C1	ON	0	1																	

Figure 8.10 shows the location of slide switches for the input/output terminal configuration.

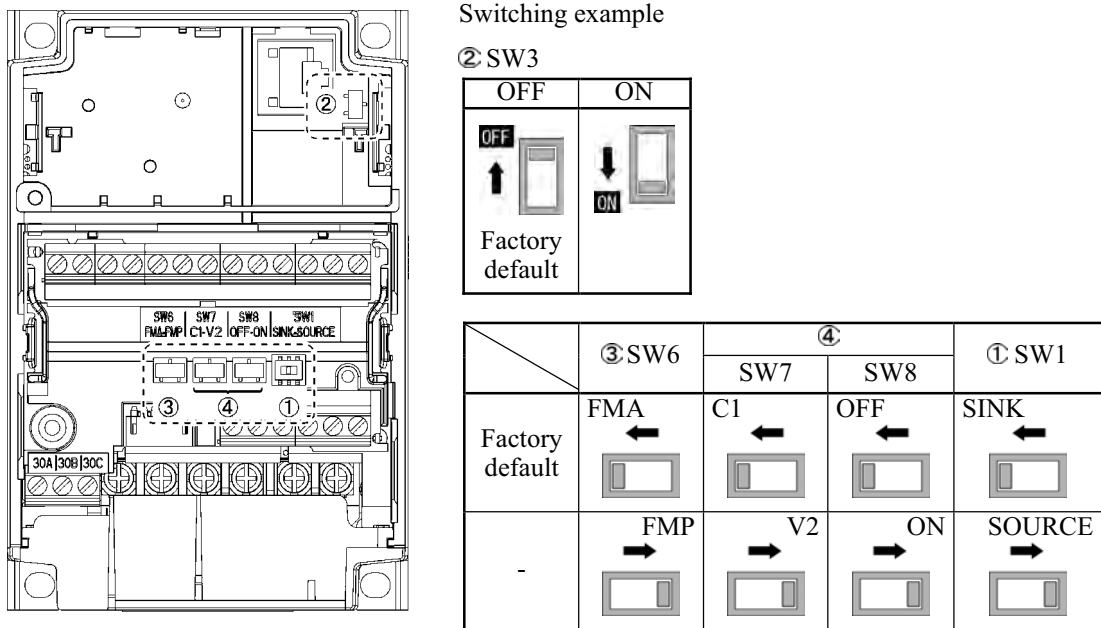

Figure 8.10 Location of the Slide Switches

8.3.2 Terminal arrangement diagram and screw specifications

8.3.2.1 Main circuit terminals

The table below shows the main circuit screw sizes, tightening torque and terminal arrangements. Note that the terminal arrangements differ according to the inverter types. Two terminals designed for grounding shown as the symbol,  G in Figures A to E make no distinction between a power supply source (a primary circuit) and a motor (a secondary circuit).

Table 8.2 Main Circuit Terminal Properties

Power supply voltage	Nominal applied motor (HP)	Inverter type	Terminal screw size	Tightening torque [lb-in (N·m)]	Grounding screw size	Tightening torque [lb-in (N·m)]	Refer to:		
Three-phase 230 V	1/8	FRNF12E1S-2U	M3.5	10.6 (1.2)	M3.5	10.6 (1.2)	Figure A		
	1/4	FRNF25E1S-2U							
	1/2	FRNF50E1S-2U							
	Three-phase 230 V	1	FRN001E1S-2U	M4	15.9 (1.8)	M4	15.9 (1.8)	Figure B	
		2	FRN002E1S-2U						
		3	FRN003E1S-2U						
		Three-phase 230 V	5	FRN005E1S-2U	M5	33.6 (3.8)	M5	33.6 (3.8)	Figure C
			7.5	FRN007E1S-2U					
			10	FRN010E1S-2U	M6	51.3 (5.8)	M6	51.3 (5.8)	
15			FRN015E1S-2U						
20		FRN020E1S-2U							
Three-phase 460 V	1/2	FRNF50E1S-4U	M4	15.9 (1.8)	M4	15.9 (1.8)	Figure B		
	1	FRN001E1S-4U							
	2	FRN002E1S-4U							
	Three-phase 460 V	3	FRN003E1S-4U	M5	33.6 (3.8)	M5	33.6 (3.8)	Figure C	
		5	FRN005E1S-4U						
		7.5	FRN007E1S-4U	M6	51.3 (5.8)	M6	51.3 (5.8)		
		10	FRN010E1S-4U						
		15	FRN015E1S-4U						
20	FRN020E1S-4U								
Single-phase 230 V	1/8	FRNF12E1S-7U	M3.5	10.6 (1.2)	M3.5	10.6 (1.2)	Figure D		
	1/4	FRNF25E1S-7U							
	1/2	FRNF50E1S-7U							
	Single-phase 230 V	1	FRN001E1S-7U	M4	15.9 (1.8)	M4	15.9 (1.8)	Figure E	
		2	FRN002E1S-7U						
		3	FRN003E1S-7U						

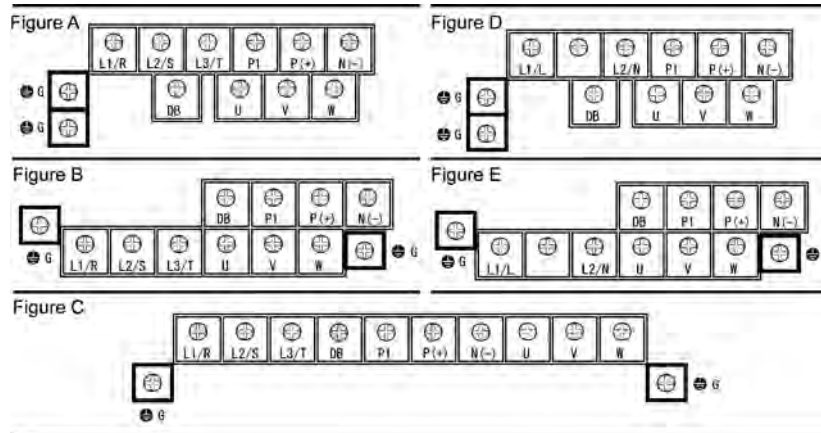

8.3.2.2 Control circuit terminals

The control circuit terminal arrangement, screw sizes, and tightening torque are shown below.

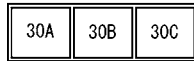
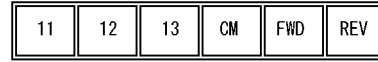

Screw size: M3, Tightening torque: 4.4 to 5.3 lb-in (0.5 to 0.6 N·m)

Table 8.3 Control Circuit Terminals

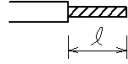
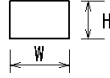
Screwdriver type	Allowable wire size	Wire strip length 	Ferrule terminal (for Europe type terminal block)* 
Flat screwdriver 0.6 x 3.5 mm	AWG26 to AWG16 (0.14 to 1.5 mm ²)	0.24 inch (6 mm)	0.10 (W) x 0.07 (H) inch (2.51 (W) x 1.76 (H) mm)

* Manufacturer of ferrule terminals: Phoenix Contact Inc. Refer to the table below.

Table 8.4 Recommended Ferrule Terminals

Screw size	Type	
	With insulated collar	Without insulated collar
AWG24 (0.25 mm ²)	AI0.25-6BU	--
AWG22 (0.34 mm ²)	AI0.34-6TQ	A0.34-7
AWG20 (0.5 mm ²)	AI0.5-6WH	A0.5-6
AWG18 (0.75 mm ²)	AI0.75-6GY	A0.75-6
AWG16 (1.25 mm ²)	AI1.5-6BK	A1.5-7

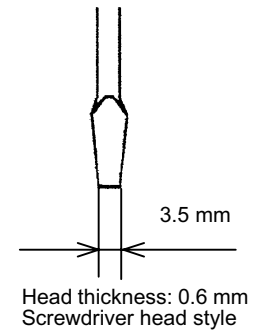

8.4 Operating Environment and Storage Environment

8.4.1 Operating environment

Install the inverter in an environment that satisfies the requirements listed in Table 8.5.

Table 8.5 Environmental Requirements

Item	Specifications	
Site location	Indoors	
Ambient temperature	-10 to +50°C (14 to 122 °F) (Note 1)	
Relative humidity	5 to 95% (No condensation)	
Atmosphere	<p>The inverter must not be exposed to dust, direct sunlight, corrosive gases, flammable gas, oil mist, vapor or water drops. Pollution degree 2 (IEC60664-1) (Note 2)</p> <p>The atmosphere can contain a small amount of salt. (0.01 mg/cm² or less per year)</p> <p>The inverter must not be subjected to sudden changes in temperature that will cause condensation to form.</p>	
Altitude	1000 m max. (Note 3)	
Atmospheric pressure	86 to 106 kPa	
Vibration	3 mm (Max. amplitude)	2 to less than 9 Hz
	9.8 m/s ²	9 to less than 20 Hz
	2 m/s ²	20 to less than 55 Hz
	1 m/s ²	55 to less than 200 Hz

(Note 1) When inverters are mounted side-by-side without any gap between them (5 HP or less), the ambient temperature should be within the range from -10 to +40°C (14 to 104 °F).

(Note 2) Do not install the inverter in an environment where it may be exposed to cotton waste or moist dust or dirt which will clog the heat sink in the inverter. If the inverter is to be used in such an environment, install it in the panel of your system or other dustproof containers.

(Note 3) If you use the inverter in an altitude above 3300 ft (1000 m), you should apply an output current derating factor as listed in Table 8.6.

Table 8.6 Output Current Derating Factor in Relation to Altitude

Altitude	Output current derating factor
3300 ft (1000 m) or lower	1.00
3301 to 4900 ft (1000 to 1500 m)	0.97
4901 to 6600 ft (1500 to 2000 m)	0.95
6601 to 8200 ft (2000 to 2500 m)	0.91
8201 to 9800 ft (2500 to 3000 m)	0.88

8.4.2 Storage environment

8.4.2.1 Temporary storage

Store the inverter in an environment that satisfies the requirements listed below.

Table 8.7 Storage and Transport Environments

Item	Specifications	
Storage temperature ^{*1}	-25 to +70°C (-13 to 158 °F)	Places not subjected to abrupt temperature changes or condensation or freezing
Relative humidity	5 to 95% ^{*2}	
Atmosphere	The inverter must not be exposed to dust, direct sunlight, corrosive or flammable gases, oil mist, vapor, water drops or vibration. The atmosphere must contain only a low level of salt. (0.01 mg/cm ² or less per year)	
Atmospheric pressure	86 to 106 kPa (during storage)	
	70 to 106 kPa (during transportation)	

*1 Assuming a comparative short time storage, e.g., during transportation or the like.

*2 Even if the humidity is within the specified requirements, avoid such places where the inverter will be subjected to sudden changes in temperature that will cause condensation to form.

Precautions for temporary storage

- (1) Do not leave the inverter directly on the floor.
- (2) If the environment does not satisfy the specified requirements listed above, wrap the inverter in an airtight vinyl sheet or the like for storage.
- (3) If the inverter is to be stored in a high-humidity environment, put a drying agent (such as silica gel) in the airtight package described in item (2).

8.4.2.2 Long-term storage

The long-term storage method of the inverter varies largely according to the environment of the storage site. General storage methods are described below.

- (1) The storage site must satisfy the requirements specified for temporary storage. However, for storage exceeding three months, the ambient temperature range should be within the range from -10 to 30°C (14 to 86 °F). This is to prevent electrolytic capacitors in the inverter from deterioration.
- (2) The package must be airtight to protect the inverter from moisture. Add a drying agent inside the package to maintain the relative humidity inside the package within 70%.
- (3) If the inverter has been installed to the equipment or panel at construction sites where it may be subjected to humidity, dust or dirt, then temporarily remove the inverter and store it in the environment specified in Table 8.7.

Precautions for storage over 1 year

If the inverter has not been powered on for a long time, the property of the electrolytic capacitors may deteriorate. Power the inverters on once a year and keep the inverters powering on for 30 to 60 minutes. Do not connect the inverters to the load circuit (secondary side) or run the inverter.

8.5 External Dimensions

8.5.1 Standard models

The diagrams below show external dimensions of the FRENIC-Multi series of inverters according to the type.

Unit: inch (mm)

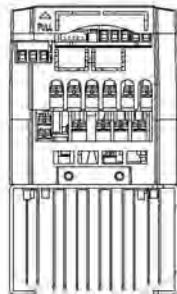
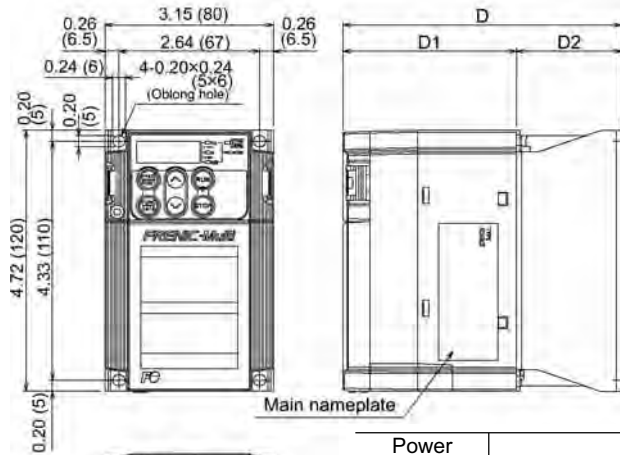

Power supply voltage	Inverter type	Dimensions [inch (mm)]		
		D	D1	D2
Three-phase 230 V	FRNF12E1S-2U	3.62 (92)	3.23 (82)	0.39 (10)
	FRNF25E1S-2U	4.21 (107)		0.98 (25)
	FRN001E1S-2U	5.2 (132)	1.97 (50)	
Single-phase 230 V	FRNF12E1S-7U	3.62 (92)	3.23 (82)	0.39 (10)
	FRNF25E1S-7U	4.21 (107)		0.98 (25)
	FRN001E1S-7U	5.98 (152)	4.02 (102)	1.97 (50)

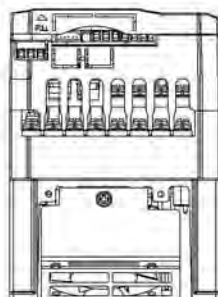
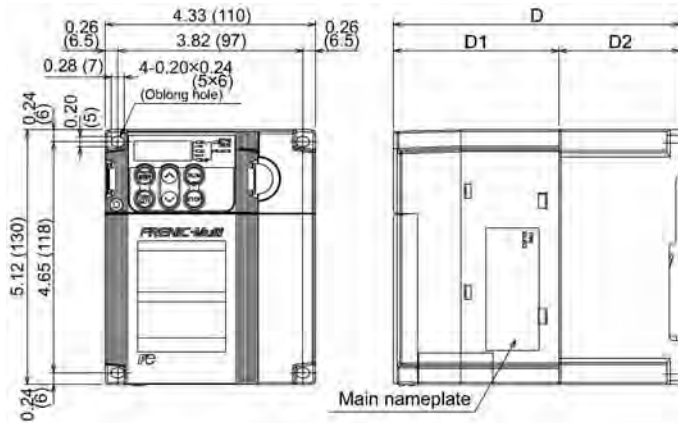

Power supply voltage	Inverter type	Dimensions [inch (mm)]		
		D	D1	D2
Three-phase 460 V	FRNF50E1S-4U	4.96 (126)	3.39 (86)	1.57 (40)
	FRN001E1S-4U	5.91 (150)		2.52 (64)

Unit: inch (mm)

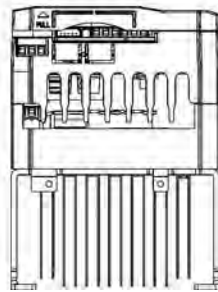
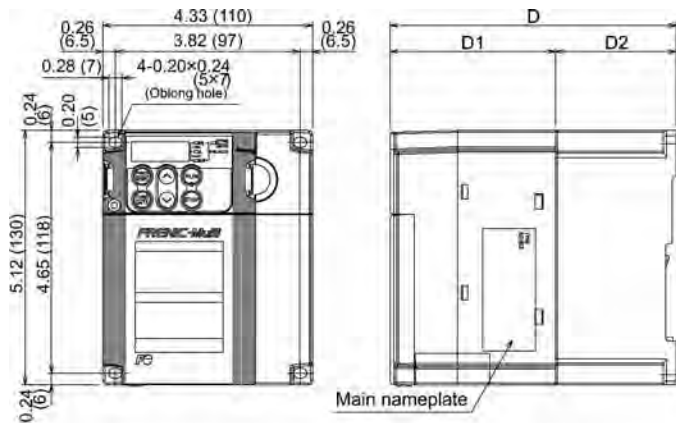

Power supply voltage	Inverter type	Dimensions [inch (mm)]		
		D	D1	D2
Three-phase 230 V	FRN002E1S-2U	5.91 (150)	3.39 (86)	2.52 (64)
	FRN003E1S-2U			
Three-phase 460 V	FRN002E1S-4U	6.30 (160)	3.78 (96)	
	FRN003E1S-4U			
Single-phase 230 V	FRN002E1S-7U			

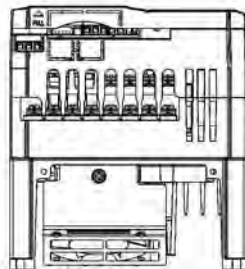
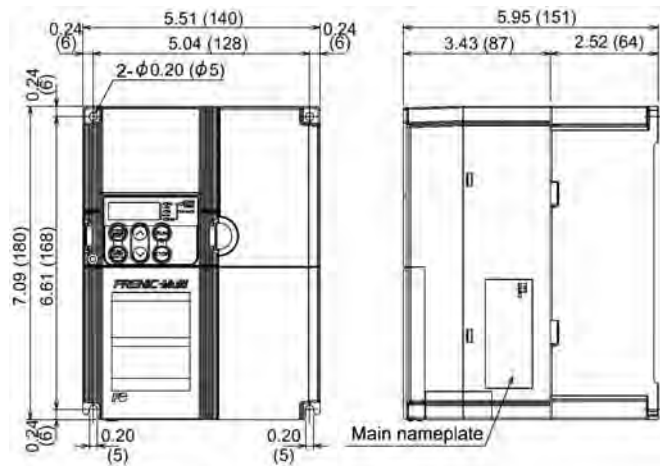

Power supply voltage	Inverter type
Three-phase 230 V	FRN005E1S-2U
Three-phase 460 V	FRN005E1S-4U
Single-phase 230 V	FRN003E1S-7U

Unit: inch (mm)

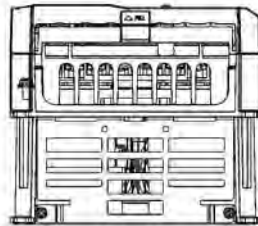
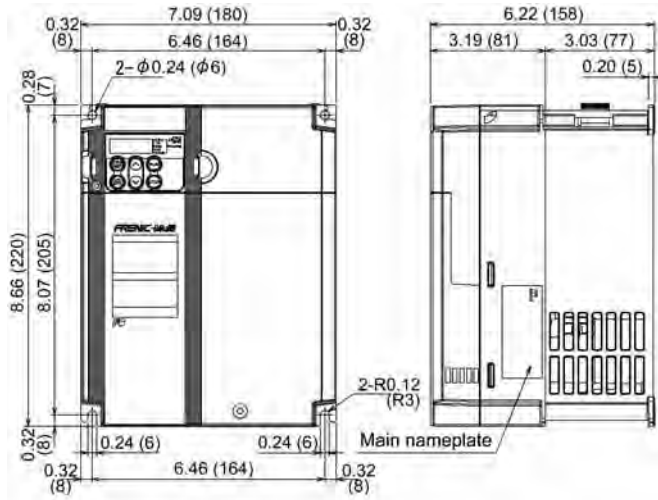

Power supply voltage	Inverter type
Three-phase 230 V	FRN007E1S-2U
	FRN010E1S-2U
Three-phase 460 V	FRN007E1S-4U
	FRN010E1S-4U

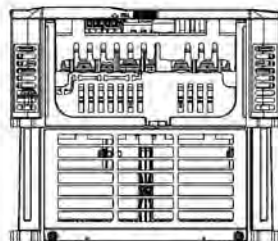
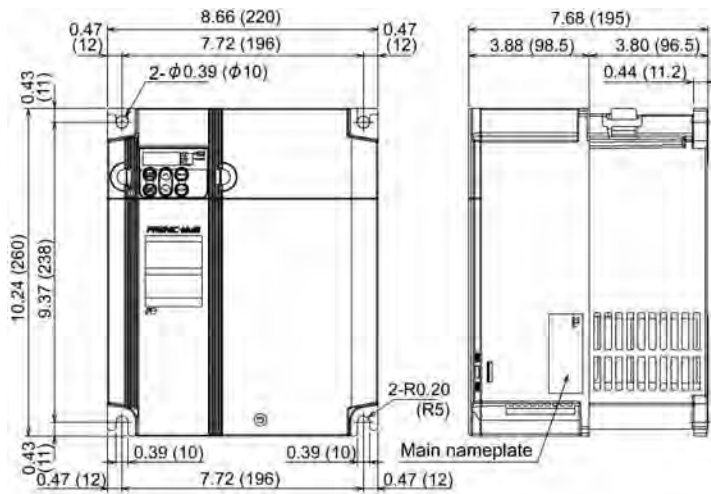

Power supply voltage	Inverter type
Three-phase 230 V	FRN015E1S-2U
	FRN020E1S-2U
Three-phase 460 V	FRN015E1S-4U
	FRN020E1S-4U

8.5.2 Standard keypad

Unit: inch (mm)

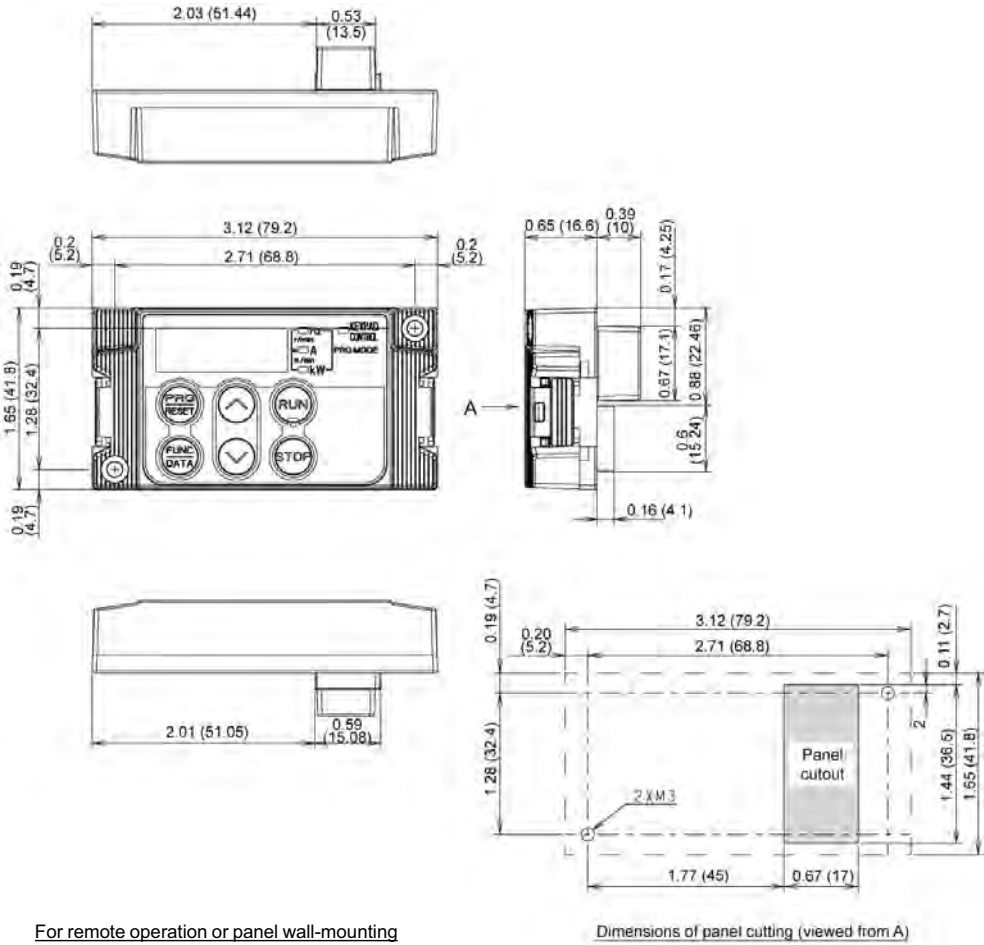

For remote operation or panel wall-mounting
(The keypad rear cover should be mounted.)

Dimensions of panel cutting (viewed from A)

8.6 Connection Diagrams

8.6.1 Running the inverter with keypad

The diagram below shows a basic connection example for running the inverter with the keypad.

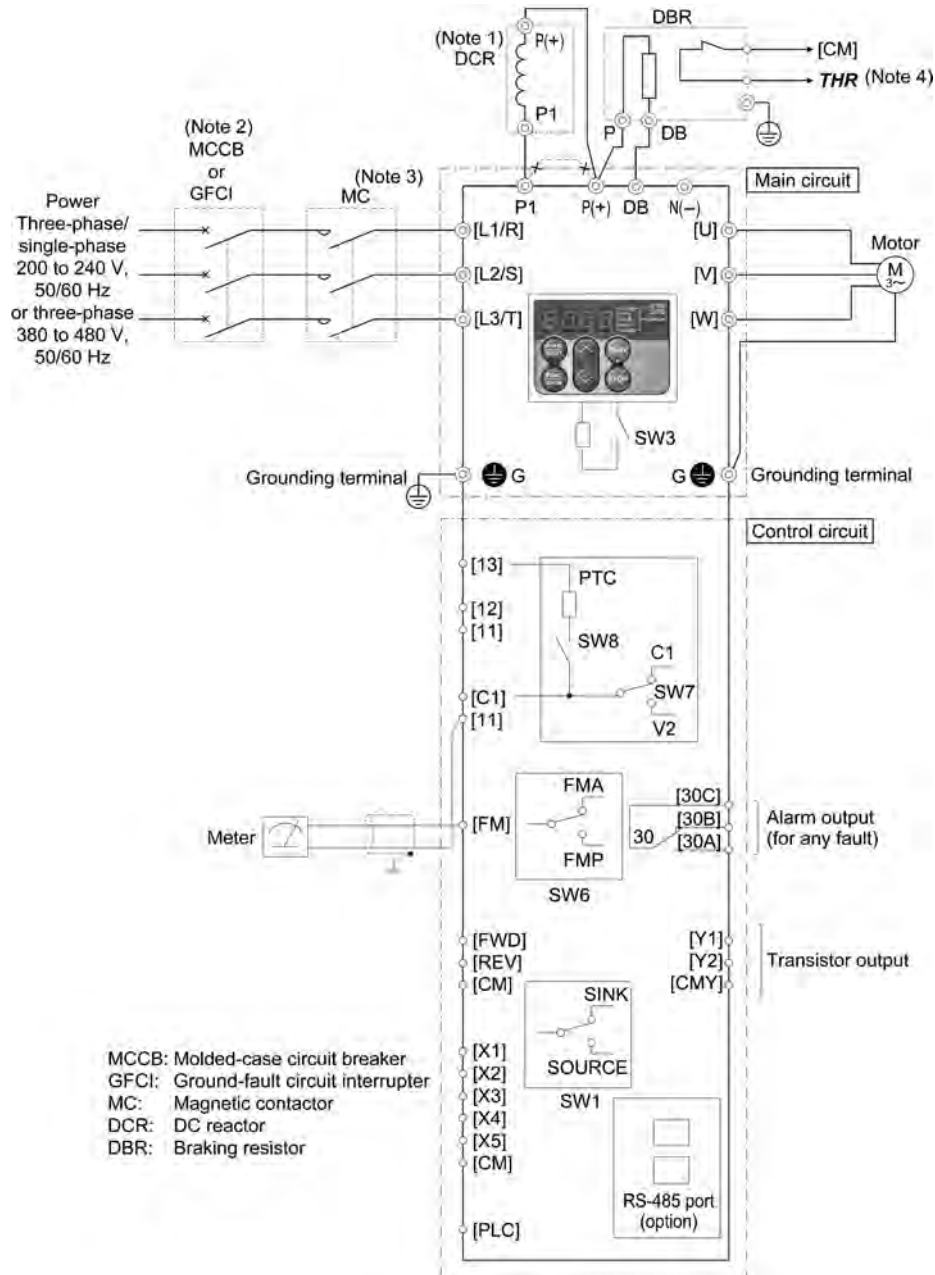

- (Note 1) When connecting an optional DC reactor (DCR), remove the jumper bar from the terminals [P1] and [P (+)].
- (Note 2) Install a recommended molded-case circuit breaker (MCCB) or a ground-fault circuit interrupter (GFCI) (with an overcurrent protection function) in the primary circuit of the inverter to protect wiring. At this time, ensure that the circuit breaker capacity is equivalent to or lower than the recommended capacity.
- (Note 3) Install a magnetic contactor (MC) for each inverter to separate the inverter from the power supply, apart from the MCCB or GFCI, when necessary.
 Connect a surge killer in parallel when installing a coil such as the MC or solenoid near the inverter.
- (Note 4) **THR** function can be used by assigning code "9" (external alarm) to any of the terminals [X1] to [X5], [FWD] and [REV] (function code; E01 to E05, E98, or E99).

8.6.2 Running the inverter by terminal commands

The diagram below shows a basic connection example for running the inverter with terminal commands.

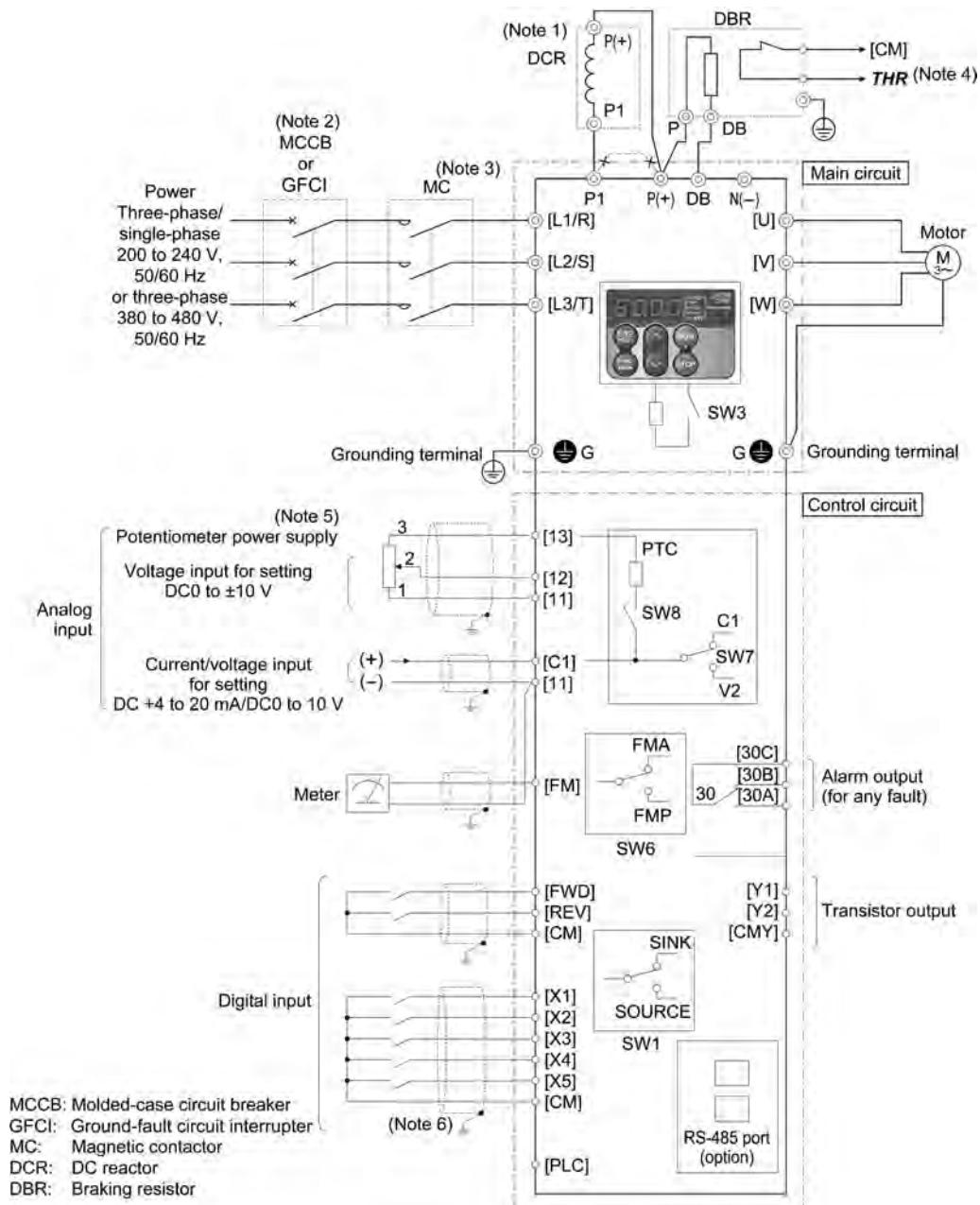

- (Note 1) When connecting an optional DC reactor (DCR), remove the jumper bar from the terminals [P1] and [P (+)].
- (Note 2) Install a recommended molded-case circuit breaker (MCCB) or a ground-fault circuit interrupter (GFCI) (with an overcurrent protection function) in the primary circuit of the inverter to protect wiring. At this time, ensure that the circuit breaker capacity is equivalent to or lower than the recommended capacity.
- (Note 3) Install a magnetic contactor (MC) for each inverter to separate the inverter from the power supply, apart from the MCCB or GFCI, when necessary.
Connect a surge killer in parallel when installing a coil such as the MC or solenoid near the inverter.
- (Note 4) **THR** function can be used by assigning code "9" (external alarm) to any of the terminals [X1] to [X5], [FWD] and [REV] (function code: E01 to E05, E98, or E99).
- (Note 5) Frequency can be set by connecting a frequency-setting device (external potentiometer) between the terminals [11], [12] and [13] instead of inputting a voltage signal (0 to +10 VDC, 0 to +5 VDC or +1 to +5 VDC) between the terminals [12] and [11].
- (Note 6) For the control signal wires, use shielded or twisted pair wires. Ground the shielded wires. To prevent malfunction due to noise, keep the control circuit wiring away from the main circuit wiring as far as possible (recommended: 10 cm or more). Never install them in the same wire duct. When crossing the control circuit wiring with the main circuit wiring, set them at right angles.

8.7 Protective Functions



The table below lists the name of the protective functions, description, alarm codes on the LED monitor, presence of alarm output at terminals [30A/B/C], and related function codes. If an alarm code appears on the LED monitor, remove the cause of activation of the alarm function referring to FRENIC-Multi Instruction Manual, Chapter 6, "TROUBLESHOOTING."

Name	Description	LED monitor displays	Alarm output [30A/B/C]
Overcurrent protection	Stops the inverter output to protect the inverter from an overcurrent resulting from overload.	OC1	Yes
Short-circuit protection	Stops the inverter output to protect the inverter from overcurrent due to a short-circuiting in the output circuit.	OC2	
Ground fault protection	Stops the inverter output to protect the inverter from overcurrent due to a ground fault in the output circuit. This protection is effective only during startup of the inverter. If you turn ON the inverter without removing the ground fault, this protection may not work.	OC3	
Overvoltage protection	Stops the inverter output upon detection of an overvoltage condition (400 VDC for three-phase 230 V, 800 VDC for three-phase 460 V) in the DC link bus. This protection is not assured if extremely large AC line voltage is applied inadvertently.	OU1	Yes
		OU2	
		OU3	
Undervoltage protection	Stops the inverter output when the DC link bus voltage drops below the undervoltage level (200 VDC for three-phase 230V, 400 VDC for three-phase 460 V). However, if data "4 or 5" is selected for F14, no alarm is output even if the DC link bus voltage drops.	UV	Yes*1
Input phase loss protection	Detects input phase loss, stopping the inverter output. This function prevents the inverter from undergoing heavy stress that may be caused by input phase loss or inter-phase voltage unbalance and may damage the inverter. If connected load is light or a DC reactor is connected to the inverter, this function will not detect input phase loss if any.	LI	Yes
Output phase loss protection	Detects breaks in inverter output wiring at the start of running and during running, stopping the inverter output.	OPL	Yes
Overheat protection	Stops the inverter output upon detecting excess heat sink temperature in case of cooling fan failure or overload.	OH1	Yes
	Discharging and inverter operation are stopped due to overheating of an external braking resistor. * Function codes must be set corresponding to the braking resistor.	OBH	Yes

*1 This alarm on [30A/B/C] should be ignored depending upon the function code setting.

Name	Description	LED monitor displays	Alarm output [30A/B/C]
Overload protection	Stops the inverter output if the Insulated Gate Bipolar Transistor (IGBT) internal temperature calculated from the output current and temperature of inside the inverter is over the preset value.	$OL1$	Yes
External alarm input	Places the inverter in alarm-stop state upon receiving digital input signal THR .	$OH2$	Yes
Motor protection	<p>Electronic thermal overload</p> <p>In the following cases, the inverter stops running the motor to protect the motor in accordance with the electronic thermal overload protection setting.</p> <ul style="list-style-type: none"> - Protects general-purpose motors over the entire frequency range (F10 = 1.) - Protects inverter motors over the entire frequency range (F10 = 2.) <p>The operation level and thermal time constant can be set by F11 and F12.</p> <p>For motor 2, read F10 to F12 as A06 to A08.</p>	$OL1$ $OL2$	Yes
	<p>PTC thermistor</p> <p>A PTC thermistor input stops the inverter output for motor protection.</p> <p>Connect a PTC thermistor between terminals [C1] and [11] and set the function codes and slide switch on the interface PCB accordingly.</p>	$OH4$	Yes
	<p>Overload early warning</p> <p>Outputs a preliminary alarm at a preset level before the inverter is stopped by the electronic thermal overload protection for the motor.</p>	—	—
Stall prevention	<p>Operates when instantaneous overcurrent limiting is active.</p> <p>Instantaneous overcurrent limiting:</p> <p>Operates if the inverter's output current exceeds the instantaneous overcurrent limit level, avoiding tripping of the inverter (during constant speed operation or during acceleration).</p>	—	—
Alarm relay output (for any fault)	<p>The inverter outputs a relay contact signal when the inverter issues an alarm and stops the inverter output.</p> <p>< Alarm reset ></p> <p>The alarm stop state is reset by pressing the  key or by the digital input signal RST.</p> <p>< Saving the alarm history and detailed data ></p> <p>The information on the previous 4 alarms can be saved and displayed.</p>	—	Yes
Memory error detection	The inverter checks memory data after power-on and when the data is written. If a memory error is detected, the inverter stops.	$Er1$	Yes
Keypad communications error detection	The inverter stops by detecting a communications error between the inverter and the keypad during operation using the standard keypad or multi-function keypad (optional).	$Er2$	Yes
CPU error detection	If the inverter detects a CPU error or LSI error caused by noise or some other factors, this function stops the inverter.	$Er3$	Yes

"—": Not applicable

Name	Description		LED monitor displays	Alarm output [30A/B/C]
Option communications error detection	Upon detection of an error in the communication between the inverter and an optional card, stops the inverter output.		<i>E_r-4</i>	—
Option error detection	When an option card has detected an error, this function stops the inverter output.		<i>E_r-5</i>	—
Operation protection	STOP key priority	Pressing the  key on the keypad forces the inverter to decelerate and stop the motor even if the inverter is running by any run commands given via the terminals or communications (link operation). After the motor stops, the inverter issues alarm <i>E_r-6</i> .	<i>E_r-6</i>	Yes
	Start check function	The inverter prohibits any run operations and displays <i>E_r-6</i> on the 7-segment LED monitor if any run command is present when: <ul style="list-style-type: none"> - Powering up - An alarm is released (the  key is turned ON or an alarm reset RST is input.) - "Enable communications link LE" has been activated and the run command is active in the linked source. 	<i>E_r-6</i>	Yes
Tuning error detection	During tuning of motor parameters, if the tuning has failed or has aborted, or an abnormal condition has been detected in the tuning result, the inverter stops its output.		<i>E_r-7</i>	Yes
RS-485 communications error detection	When the inverter is connected to a communications network via the RS-485 port designed for the keypad, detecting a communications error stops the inverter output and displays an error code <i>E_r-8</i> .		<i>E_r-8</i>	Yes
Data save error during under-voltage	If the data could not be saved during activation of the undervoltage protection function, the inverter displays the alarm code.		<i>E_r-F</i>	Yes
RS-485 communications error detection (optional)	When the inverter is connected to a communications network via an optional RS-485 communications card, detecting a communications error stops the inverter output and displays an error code <i>E_r-P</i> .		<i>E_r-P</i>	Yes
Retry	When the inverter has stopped because of a trip, this function allows the inverter to automatically reset itself and restart. (You can specify the number of retries and the latency between stop and reset.)		—	—
Surge protection	Protects the inverter against surge voltages which might appear between one of the power lines for the main circuit and the ground.		—	—
Command loss detected	Upon detecting a loss of a frequency command (because of a broken wire, etc.), this function issues an alarm and continues the inverter operation at the preset reference frequency (specified as a ratio to the frequency just before the detection).		—	—
Protection against momentary power failure	Upon detecting a momentary power failure lasting more than 15 ms, this function stops the inverter output. If restart after momentary power failure is selected, this function invokes a restart process when power has been restored within a predetermined period.		—	—

"—": Not applicable

Name	Description	LED monitor displays	Alarm output [30A/B/C]
Overload prevention control	In the event of overheating of the heat sink or an overload condition (alarm code: \overline{OH} or \overline{OL}), the output frequency of the inverter is reduced to keep the inverter from tripping.	—	—
Hardware error	The inverter is stopped when poor connection between the control printed circuit board (control PCB) and power printed circuit board (power PCB), interface printed circuit board (interface PCB) or option card, or short-circuit between terminals [13] and [11] is detected.	\overline{Err}	Yes
Mock alarm	Simulated alarm is output to check the fault sequence.	\overline{Err}	Yes

"—": Not applicable

Chapter 9

FUNCTION CODES

This chapter contains overview lists of function codes available for the FRENIC-Multi series of inverters and details of each function code.

Contents

9.1	Function Code Tables.....	9-1
9.2	Overview of Function Codes	9-14
9.2.1	F codes (Fundamental functions).....	9-14
9.2.2	E codes (Extension terminal functions).....	9-43
9.2.3	C codes (Control functions).....	9-70
9.2.4	P codes (Motor 1 parameters)	9-77
9.2.5	H codes (High performance functions).....	9-80
9.2.6	A codes (Motor 2 parameters).....	9-102
9.2.7	J codes (Application functions).....	9-104
9.2.8	y codes (Link functions).....	9-119

9.1 Function Code Tables

Function codes enable the FRENIC-Multi series of inverters to be set up to match your system requirements.









Each function code consists of a 3-letter alphanumeric string. The first letter is an alphabet that identifies its group and the following two letters are numerals that identify each individual code in the group. The function codes are classified into nine groups: Fundamental Functions (F codes), Extension Terminal Functions (E codes), Control Functions (C codes), Motor 1 Parameters (P codes), High Performance Functions (H codes), Motor 2 Parameters (A codes), Application Functions (J codes), Link Functions (y codes) and Option Functions (o codes). To determine the property of each function code, set data to the function code.

This manual does not contain the descriptions of Option Function (o codes). For Option Function (o codes), refer to the instruction manual for each option.

The following descriptions supplement those given in the function code tables on page 9-3 and subsequent pages.

■ Changing, validating, and saving function code data when the inverter is running

Function codes are indicated by the following based on whether they can be changed or not when the inverter is running:

Notation	Change when running	Validating and saving function code data
Y*	Possible	If the data of the codes marked with Y* is changed with  and  keys, the change will immediately take effect; however, the change is not saved into the inverter's memory. To save the change, press the  key. If you press the  key without pressing the  key to exit the current state, then the changed data will be discarded and the previous data will take effect for the inverter operation.
Y	Possible	Even if the data of the codes marked with Y is changed with  and  keys, the change will not take effect. Pressing the  key will make the change take effect and save it into the inverter's memory.
N	Impossible	—

■ Copying data

The data copying feature copies the function code data stored in the inverter's memory into the keypad's memory. With this feature, you can easily transfer the data saved in a source inverter to other destination inverters.

The standard keypad does not support this feature. The optional multi-function keypad supports it with Menu #8 in Programming mode.

If the specifications of the source and destination inverters differ, some code data may not be copied to ensure safe operation of your power system. Whether data will be copied or not is detailed with the following symbols in the "Data copying" column of the function code tables given below.

Y: Will be copied unconditionally.

Y1: Will not be copied if the rated capacity differs from the source inverter.

Y2: Will not be copied if the rated input voltage differs from the source inverter.

N: Will not be copied. (The function code marked with "N" is not subject to the Verify operation, either.)

If necessary, set up uncopied code data manually and individually.

■ Using negative logic for programmable I/O terminals

The negative logic signaling system can be used for the digital input and output terminals by setting the function code data specifying the properties for those terminals. Negative logic refers to the inverted ON/OFF (logical value 1 (true)/0 (false)) state of input or output signal. An active-ON signal (the function takes effect if the terminal is short-circuited.) in the normal logic system is functionally equivalent to active-OFF signal (the function takes effect if the terminal is opened.) in the negative logic system. An active-ON signal can be switched to active-OFF signal, and vice versa, with the function code data setting.

To set the negative logic system for an I/O terminal, enter data of 1000s (by adding 1000 to the data for the normal logic) in the corresponding function code. Some signals cannot switch to active-OFF depending upon their assigned functions.

Example: "Coast to a stop" command **BX** assigned to any of digital input terminals [X1] to [X5] using any of function codes E01 through E05

Function code data	BX
7	Turning BX ON causes the motor to coast to a stop. (Active-ON)
1007	Turning BX OFF causes the motor to coast to a stop. (Active-OFF)

The following tables list the function codes available for the FRENIC-Multi series of inverters

F codes: Fundamental Functions

Code	Name	Data setting range	Increment	Unit	Change when running	Data copying	Default setting	Refer to page:
F00	Data Protection	0: Disable both data protection and digital reference protection 1: Enable data protection and disable digital reference protection 2: Disable data protection and enable digital reference protection 3: Enable both data protection and digital reference protection	—	—	Y	Y	0	9-14
F01	Frequency Command 1	0: UP/DOWN keys on keypad 1: Voltage input to terminal [12] (-10 to +10 VDC) 2: Current input to terminal [C1] (C1 function) (4 to 20 mA DC) 3: Sum of voltage and current inputs to terminals [12] and [C1] (C1 function) 5: Voltage input to terminal [C1] (V2 function) (0 to 10 VDC) 7: Terminal command UP/DOWN control 11: DIO interface card (option) 12: PG interface card (option)	—	—	N	Y	0	
F02	Operation Method	0: RUN/STOP keys on keypad (Motor rotational direction specified by terminal command FWD/REV) 1: Terminal command FWD or REV 2: RUN/STOP keys on keypad (forward) 3: RUN/STOP keys on keypad (reverse)	—	—	N	Y	2	9-15
F03	Maximum Frequency 1	25.0 to 400.0	0.1	Hz	N	Y	60.0	9-16
F04	Base Frequency 1	25.0 to 400.0	0.1	Hz	N	Y	60.0	
F05	Rated Voltage at Base Frequency	0: Output a voltage in proportion to input voltage 80 to 240: Output an AVR-controlled voltage (for 230 V) 160 to 500: Output an AVR-controlled voltage (for 460 V)	1	V	N	Y2	230 460	
F06	Maximum Output Voltage 1	80 to 240: Output an AVR-controlled voltage (for 230 V) 160 to 500: Output an AVR-controlled voltage (for 460 V)	1	V	N	Y2	230 460	
F07	Acceleration Time 1	0.00 to 3600 Note: Entering 0.00 cancels the acceleration time, requiring external soft-start.	0.01	s	Y	Y	6.00	9-18
F08	Deceleration Time 1	0.00 to 3600 Note: Entering 0.00 cancels the deceleration time, requiring external soft-start.	0.01	s	Y	Y	6.00	
F09	Torque Boost 1	0.0 to 20.0 (percentage with respect to "F05: Rated Voltage at Base Frequency 1") Note: This setting takes effect when F37 = 0, 1, 3, or 4.	0.1	%	Y	Y	Depending on the inverter capacity	
F10	Electronic Thermal Overload Protection for Motor 1 (Select motor characteristics)	1: For a general-purpose motor with shaft-driven cooling fan 2: For an inverter-driven motor, non-ventilated motor, or motor with separately powered cooling fan	—	—	Y	Y	1	9-21
F11	(Overload detection level)	0.00: Disable 0.01 to 100.00 1 to 135% of the rated current (allowable continuous drive current) of the motor	0.01	A	Y	Y1 Y2	100% of the motor rated current	
F12	(Thermal time constant)	0.5 to 75.0	0.1	min	Y	Y	5.0	
F14	Restart Mode after Momentary Power Failure (Mode selection)	0: Disable restart (Trip immediately) 1: Disable restart (Trip after a recovery from power failure) 4: Enable restart (Restart at the frequency at which the power failure occurred, for general loads) 5: Enable restart (Restart at the starting frequency, for low-inertia load)	—	—	Y	Y	0	9-24
F15	Frequency Limiter (High)	0.0 to 400.0	0.1	Hz	Y	Y	70.0	9-28
F16	(Low)	0.0 to 400.0	0.1	Hz	Y	Y	0.0	
F18	Bias (Frequency command 1)	-100.00 to 100.00 *1	0.01	%	Y*	Y	0.00	9-29
F20	DC Braking 1 (Braking starting frequency)	0.0 to 60.0	0.1	Hz	Y	Y	0.0	9-32
F21	(Braking level)	0 to 100	1	%	Y	Y	0	
F22	(Braking time)	0.00 : Disable 0.01 to 30.00	0.01	s	Y	Y	0.00	
F23	Starting Frequency 1	0.1 to 60.0	0.1	Hz	Y	Y	0.5	9-33
F24	(Holding time)	0.00 to 10.00	0.01	s	Y	Y	0.00	
F25	Stop Frequency	0.1 to 60.0	0.1	Hz	Y	Y	0.2	
F26	Motor Sound (Carrier frequency)	0.75 to 15	1	kHz	Y	Y	2	9-34
F27	(Tone)	0: Level 0 (Inactive) 1: Level 1 2: Level 2 3: Level 3	—	—	Y	Y	0	

The shaded function codes () are applicable to the quick setup.

*¹ When you make settings from the keypad, the incremental unit is restricted by the number of digits that the LED monitor can display.

(Example) If the setting range is from -200.00 to 200.00, the incremental unit is:

"1" for -200 to -100, "0.1" for -99.9 to -10.0 and for 100.0 to 200.0, and "0.01" for -9.99 to -0.01 and for 0.00 to 99.99.

(F code continued)

Code	Name	Data setting range	Increment	Unit	Change when running	Data copying	Default setting	Refer to page:
F29	Analog Output [FM] (Mode selection)	0: Output in voltage (0 to 10 VDC) (<i>FMA</i>) 2: Output in pulse (0 to 6000 p/s) (<i>FMP</i>)	—	—	Y	Y	0	9-35
F30	(Voltage adjustment)	0 to 300 (<i>FMA</i>)	1	%	Y*	Y	100	
F31	(Function)	Select a function to be monitored from the followings. 0: Output frequency 1 (before slip compensation) 1: Output frequency 2 (after slip compensation) 2: Output current 3: Output voltage 4: Output torque 5: Load factor 6: Input power 7: PID feedback amount (PV) 8: PG feedback value 9: DC link bus voltage 10: Universal AO 13: Motor output 14: Calibration 15: PID command (SV) 16: PID output (MV)	—	—	Y	Y	0	
F33	(Pulse rate)	25 to 6000 (<i>FMP</i> , Pulse rate at 100% output)	1	p/s	Y*	Y	1440	
F37	Load Selection/Auto Torque Boost/ Auto Energy Saving Operation 1	0: Variable torque load 1: Constant torque load 2: Auto-torque boost 3: Auto-energy saving operation (Variable torque load during ACC/DEC) 4: Auto-energy saving operation (Constant torque load during ACC/DEC) 5: Auto-energy saving operation (Auto-torque boost during ACC/DEC)	—	—	N	Y	1	9-18 9-37
F39	Stop Frequency (Holding Time)	0.00 to 10.00	0.01	s	Y	Y	0.00	9-33 9-37
F40	Torque Limiter 1 (Limiting level for driving)	20 to 200 999: Disable	1	%	Y	Y	999	9-37
F41	(Limiting level for braking)	20 to 200 999: Disable	1	%	Y	Y	999	
F42	Control Mode Selection 1	0: V/f control with slip compensation inactive 1: Dynamic torque vector control 2: V/f control with slip compensation active 3: V/f control with optional PG interface 4: Dynamic torque vector control with optional PG interface	—	—	N	Y	0	
F43	Current Limiter (Mode selection)	0: Disable (No current limiter works.) 1: Enable at constant speed (Disable during ACC/DEC) 2: Enable during ACC/constant speed operation	—	—	Y	Y	2	9-39
F44	(Level)	20 to 200 (The data is interpreted as the rated output current of the inverter for 100%.)	1	%	Y	Y	180	
F50	Electronic Thermal Overload Protection for Braking Resistor (Discharging capability)	1 to 900 999: Disable 0: Reserved	1	kWs	Y	Y	999	
F51	(Allowable average loss)	0.001 to 50.000 0.000: Reserved	0.001	kW	Y	Y	0.000	

E codes: Extension Terminal Functions

Code	Name	Data setting range	Increment	Unit	Change when running	Data copying	Default setting	Refer to page:
E01	Terminal [X1] Function	Selecting function code data assigns the corresponding function to terminals [X1] to [X5] as listed below.	—	—	N	Y	0	9-43
E02	Terminal [X2] Function	0 (1000): Select multi-frequency (SS1)	—	—	N	Y	1	
E03	Terminal [X3] Function	1 (1001): Select multi-frequency (SS2)	—	—	N	Y	2	
E04	Terminal [X4] Function	2 (1002): Select multi-frequency (SS4)	—	—	N	Y	7	
E05	Terminal [X5] Function	3 (1003): Select multi-frequency (SS8)	—	—	N	Y	8	
		4 (1004): Select ACC/DEC time (RT1)						
		6 (1006): Enable 3-wire operation (HLD)						
		7 (1007): Coast to a stop (BX)						
		8 (1008): Reset alarm (RST)						
		9 (1009): Enable external alarm trip (THR)						
		10 (1010): Ready for jogging (JOG)						
		11 (1011): Select frequency command 2/1 (Hz2/Hz1)						
		12 (1012): Select motor 2/motor 1 (M2/M1)						
		13 : Enable DC braking (DCBRK)						
		14 (1014): Select torque limiter level (TL2/TL1)						
		17 (1017): UP (Increase output frequency) (UP)						
		18 (1018): DOWN (Decrease output frequency) (DOWN)						
		19 (1019): Enable data change with keypad (WE-KP)						
		20 (1020): Cancel PID control (Hz/PID)						
		21 (1021): Switch normal/inverse operation (IVS)						
		24 (1024): Enable communications link via RS-485 or field bus (LE)						
		25 (1025): Universal DI (U-DI)						
		26 (1026): Enable auto search for idling motor speed at starting (STM)						
		30 (1030): Force to stop (STOP)						
		33 (1033): Reset PID integral and differential components (PID-RST)						
		34 (1034): Hold PID integral component (PID-HLD)						
		42 (1042): Reserved *2						
		43 (1043): Reserved *2						
		44 (1044): Reserved *2						
		45 (1045): Reserved *2						
		Setting the value of 1000s in parentheses () shown above assigns a negative logic input to a terminal. Note: In the case of THR and STOP, data (1009) and (1030) are for normal logic, and "9" and "30" are for negative logic, respectively.						
E10	Acceleration Time 2	0.00 to 3600 Note: Entering 0.00 cancels the acceleration time, requiring external soft-start.	0.01	s	Y	Y	10.0	9-18 9-55
E11	Deceleration Time 2	0.00 to 3600 Note: Entering 0.00 cancels the acceleration time, requiring external soft-start.	0.01	s	Y	Y	10.0	
E16	Torque Limiter 2 (Limiting level for driving)	20 to 200 999 : Disable	1	%	Y	Y	999	9-37 9-55
E17	(Limiting level for braking)	20 to 200 999 : Disable	1	%	Y	Y	999	
E20	Terminal [Y1] Function	Selecting function code data assigns the corresponding function to terminals [Y1], [Y2], and [30A/B/C] as listed below.	—	—	N	Y	0	9-55
E21	Terminal [Y2] Function	0 (1000): Inverter running (RUN)	—	—	N	Y	7	
E27	Terminal [30A/B/C] Function	1 (1001): Frequency arrival signal (FAR)	—	—	N	Y	99	
		2 (1002): Frequency detected (FDT)						
		3 (1003): Undervoltage detected (LU) (Inverter stopped)						
		4 (1004): Torque polarity detected (B/D)						
		5 (1005): Inverter output limiting (IOL)						
		6 (1006): Auto-restarting after momentary power failure (IPF)						
		7 (1007): Motor overload early warning (OL)						
		10 (1010): Inverter ready to run (RDY)						
		21 (1021): Frequency arrival signal 2 (FAR2)						
		22 (1022): Inverter output limiting with delay (IOL2)						
		26 (1026): Auto-resetting (TRY)						
		28 (1028): Heat sink overheat early warning (OH)						
		30 (1030): Service lifetime alarm (LIFE)						
		33 (1033): Reference loss detected (REF OFF)						
		35 (1035): Inverter output on (RUN2)						
		36 (1036): Overload prevention control (OLP)						
		37 (1037): Current detected (ID)						
		38 (1038): Current detected 2 (ID2)						
		42 (1042): PID alarm (PID-ALM)						
		49 (1049): Switched to motor 2 (SWM2)						
		57 (1057): Brake signal (BRKS)						
		80 (1080): Reserved *2						
		81 (1081): Reserved *2						
		82 (1082): Reserved *2						
		99 (1099): Alarm output (for any alarm) (ALM)						
		Setting the value of 1000s in parentheses () shown above assigns a negative logic input to a terminal.						

*2 These function codes and their data are displayed, but they are reserved for particular manufacturers. Unless otherwise specified, do not access these function codes.

(E code continued)

Code	Name	Data setting range	Increment	Unit	Change when running	Data copying	Default setting	Refer to page:
E29	Frequency Arrival Delay Time	0.01 to 10.00	0.01	s	Y	Y	0.10	9-60
E30	Frequency Arrival (Hysteresis width)	0.0 to 10.0	0.1	Hz	Y	Y	2.5	
E31	Frequency Detection (FDT) (Detection level)	0.0 to 400.0	0.1	Hz	Y	Y	60.0	
E32	(Hysteresis width)	0.0 to 400.0	0.1	Hz	Y	Y	1.0	9-61
E34	Overload Early Warning/Current Detection (Level)	0.00 : Disable Current value of 1 to 200% of the inverter rated current	0.01	A	Y	Y1 Y2	100% of the motor rated current	
E35	(Timer)	0.01 to 600.00 *1	0.01	s	Y	Y	10.00	
E37	Current Detection 2 (Level)	0.00 : Disable Current value of 1 to 200% of the inverter rated current	0.01	A	Y	Y1 Y2	100% of the motor rated current	
E38	(Timer)	0.01 to 600.00 *1	0.01	s	Y	Y	10.00	9-62
E39	Coefficient for Constant Feeding Rate Time	0.000 to 9.999	0.001	—	Y	Y	0.000	
E40	PID Display Coefficient A	-999 to 0.00 to 9990 *1	0.01	—	Y	Y	100	
E41	PID Display Coefficient B	-999 to 0.00 to 9990 *1	0.01	—	Y	Y	0.00	9-63
E42	LED Display Filter	0.0 to 5.0	0.1	s	Y	Y	0.5	
E43	LED Monitor (Item selection)	0: Speed monitor (select by E48) 3: Output current 4: Output voltage 8: Calculated torque 9: Input power 10: PID command 12: PID feedback amount 13: Timer 14: PID output 15: Load factor 16: Motor output 21: Reserved *2 22: Reserved *2	—	—	Y	Y	0	9-64
E45	LCD Monitor *3 (Item selection)	0: Running status, rotational direction and operation guide 1: Bar charts for output frequency, current and calculated torque	—	—	Y	Y	0	9-65
E46	(Language selection)	0: Japanese 1: English 2: German 3: French 4: Spanish 5: Italian	—	—	Y	Y	1	9-66
E47	(Contrast control)	0 (Low) to 10 (High)	1	—	Y	Y	5	9-64 9-66
E48	LED Monitor (Speed monitor item)	0: Output frequency (Before slip compensation) 1: Output frequency (After slip compensation) 2: Reference frequency 3: Motor speed in r/min 4: Load shaft speed in r/min 5: Line speed in m/min 6: Constant feeding rate time	—	—	Y	Y	0	
E50	Coefficient for Speed Indication	0.01 to 200.00 *1	0.01	—	Y	Y	30.00	9-62 9-66
E51	Display Coefficient for Input Watt-hour Data	0.000 (Cancel/reset) 0.001 to 9999	0.001	—	Y	Y	0.010	9-66
E52	Keypad (Menu display mode)	0: Function code data editing mode (Menus #0 and #1) 1: Function code data check mode (Menu #2) 2: Full-menu mode (Menus #0 through #6)	—	—	Y	Y	0	9-67
E59	Terminal [C1] Signal Definition (C1/V2 Function)	0: Current input (C1 function), 4 to 20 mADC 1: Voltage input (V2 function), 0 to +10 VDC	—	—	N	Y	0	9-68
E61	Terminal [12] Extended Function	Selecting function code data assigns the corresponding function to terminals [12] and [C1] (C1/V2 function) as listed below.	—	—	N	Y	0	9-69
E62	Terminal [C1] Extended Function (C1 function)	0: None 1: Auxiliary frequency command 1	—	—	N	Y	0	
E63	Terminal [C1] Extended Function (V2 function)	2: Auxiliary frequency command 2 3: PID command 1 5: PID feedback amount	—	—	N	Y	0	
E65	Reference Loss Detection (Continuous running frequency)	0: Decelerate to stop 20 to 120 999: Disable	1	%	Y	Y	999	9-69

The shaded function codes () are applicable to the quick setup.

*¹ When you make settings from the keypad, the incremental unit is restricted by the number of digits that the LED monitor can display.

(Example) If the setting range is from -200.00 to 200.00, the incremental unit is:

"1" for -200 to -100, "0.1" for -99.9 to -10.0 and for 100.0 to 200.0, and "0.01" for -9.99 to -0.01 and for 0.00 to 99.99.

*² These function codes and their data are displayed, but they are reserved for particular manufacturers. Unless otherwise specified, do not access these function codes.

*³ These function codes are for use with an optional multi-function keypad.

(E code continued)

Code	Name	Data setting range	Incr- ment	Unit	Change when running	Data copying	Default setting	Refer to page:
E98	Terminal [FWD] Function	Selecting function code data assigns the corresponding function to terminals [FWD] and [REV] as listed below.	—	—	N	Y	98	9-43
E99	Terminal [REV] Function	0 (1000): Select multi-frequency (<i>SS1</i>) 1 (1001): Select multi-frequency (<i>SS2</i>) 2 (1002): Select multi-frequency (<i>SS4</i>) 3 (1003): Select multi-frequency (<i>SS8</i>) 4 (1004): Select ACC/DEC time (<i>RT1</i>) 6 (1006): Enable 3-wire operation (<i>HLD</i>) 7 (1007): Coast to a stop (<i>BX</i>) 8 (1008): Reset alarm (<i>RST</i>) 9 (1009): Enable external alarm trip (<i>THR</i>) 10 (1010): Ready for jogging (<i>JOG</i>) 11 (1011): Select frequency command 2/1 (<i>Hz2/Hz1</i>) 12 (1012): Select motor 2/motor 1 (<i>M2/M1</i>) 13 : Enable DC braking (<i>DCBRK</i>) 14 (1014): Select torque limiter level (<i>TL2/TL1</i>) 17 (1017): UP (Increase output frequency) (<i>UP</i>) 18 (1018): DOWN (Decrease output frequency) (<i>DOWN</i>) 19 (1019): Enable data change with keypad (<i>WE-KP</i>) 20 (1020): Cancel PID control (<i>Hz/PID</i>) 21 (1021): Switch normal/inverse operation (<i>IVS</i>) 24 (1024): Enable communications link via RS-485 or field bus (<i>LE</i>) 25 (1025): Universal DI (<i>U-DI</i>) 26 (1026): Enable auto search for idling motor speed at starting (<i>STM</i>) 30 (1030): Force to stop (<i>STOP</i>) 33 (1033): Reset PID integral and differential components (<i>PID-RST</i>) 34 (1034): Hold PID integral component (<i>PID-HLD</i>) 42 (1042): Reserved *2 43 (1043): Reserved *2 44 (1044): Reserved *2 45 (1045): Reserved *2 98 : Run forward (<i>FWD</i>) 99 : Run reverse (<i>REV</i>) Setting the value of 1000s in parentheses () shown above assigns a negative logic input to a terminal. Note: In the case of <i>THR</i> and <i>STOP</i> , data (1009) and (1030) are for normal logic, and "9" and "30" are for negative logic, respectively.	—	—	N	Y	99	9-69

C codes: Control Functions

Code	Name	Data setting range	Incr- ment	Unit	Change when running	Data copying	Default setting	Refer to page:
C01	Jump Frequency 1	0.0 to 400.0	0.1	Hz	Y	Y	0.00	9-70
C02	2				Y	Y	0.00	
C03	3				Y	Y	0.00	
C04	(Hysteresis width)	0.0 to 30.0	0.1	Hz	Y	Y	3.0	
C05	Multi-Frequency 1	0.00 to 400.0	0.01	Hz	Y	Y	0.00	9-71
C06	2				Y	Y	0.00	
C07	3				Y	Y	0.00	
C08	4				Y	Y	0.00	
C09	5				Y	Y	0.00	
C10	6				Y	Y	0.00	
C11	7				Y	Y	0.00	
C12	8				Y	Y	0.00	
C13	9				Y	Y	0.00	
C14	10				Y	Y	0.00	
C15	11				Y	Y	0.00	
C16	12	Y	Y	0.00				
C17	13	Y	Y	0.00				
C18	14	Y	Y	0.00				
C19	15	Y	Y	0.00				
C20	Jogging Frequency	0.00 to 400.0	0.01	Hz	Y	Y	0.00	9-72
C21	Timer Operation	0: Disable 1: Enable	—	—	N	Y	0	9-73
C30	Frequency Command 2	0: UP/DOWN keys on keypad 1: Voltage input to terminal [12] (-10 to +10 VDC) 2: Current input to terminal [C1] (C1 function) (4 to 20 mA DC) 3: Sum of voltage and current inputs to terminals [12] and [C1] (C1 function) 5: Voltage input to terminal [C1] (V2 function) (0 to 10 VDC) 7: Terminal command <i>UP/DOWN</i> control 11: DIO interface card (option) 12: PG interface card (option)	—	—	N	Y	2	9-14 9-73

*2 These function codes and their data are displayed, but they are reserved for particular manufacturers. Unless otherwise specified, do not access these function codes.

(C code continued)

Code	Name	Data setting range	Increment	Unit	Change when running	Data copying	Default setting	Refer to page:
C31	Analog Input Adjustment for [12] (Offset)	-5.0 to 5.0	0.1	%	Y*	Y	0.0	9-74
C32	(Gain)	0.00 to 200.00 *1	0.01	%	Y*	Y	100.0	9-29 9-74
C33	(Filter time constant)	0.00 to 5.00	0.01	s	Y	Y	0.05	9-74
C34	(Gain base point)	0.00 to 100.00 *1	0.01	%	Y*	Y	100.0	9-29 9-74
C35	(Polarity)	0: Bipolar 1: Unipolar	—	—	N	Y	1	9-74
C36	Analog Input Adjustment for [C1] (C1 function) (Offset)	-5.0 to 5.0	0.1	%	Y*	Y	0.0	9-74 9-75
C37	(Gain)	0.00 to 200.00 *1	0.01	%	Y*	Y	100.0	9-29 9-75
C38	(Filter time constant)	0.00 to 5.00	0.01	s	Y	Y	0.05	9-74 9-75
C39	(Gain base point)	0.00 to 100.00 *1	0.01	%	Y*	Y	100.0	9-29 9-75
C41	Analog Input Adjustment for [C1] (V2 function) (Offset)	-5.0 to 5.0	0.1	%	Y*	Y	0.0	9-74 9-75
C42	(Gain)	0.00 to 200.00 *1	0.01	%	Y*	Y	100.0	9-29 9-75
C43	(Filter time constant)	0.00 to 5.00	0.01	s	Y	Y	0.05	9-74 9-75
C44	(Gain base point)	0.00 to 100.00 *1	0.01	%	Y*	Y	100.0	9-29
C50	Bias (Frequency command 1) (Bias base point)	0.00 to 100.00 *1	0.01	%	Y*	Y	0.00	9-75
C51	Bias (PID command 1) (Bias value)	-100.00 to 100.00	0.01	%	Y*	Y	0.00	9-76
C52	(Bias base point)	0.00 to 100.00 *1	0.01	%	Y*	Y	0.00	
C53	Selection of Normal/Inverse Operation (Frequency command 1)	0: Normal operation 1: Inverse operation	—	—	Y	Y	0	

P codes: Motor 1 Parameters

Code	Name	Data setting range	Increment	Unit	Change when running	Data copying	Default setting	Refer to page:
P01	Motor 1 (No. of poles)	2 to 22	2	poles	N	Y1 Y2	4	9-77
P02	(Rated capacity)	0.01 to 30.00 (where, P99 data is 0, 3, or 4.) 0.01 to 30.00 (where, P99 data is 1.)	0.01 0.01	kW HP	N	Y1 Y2	Rated capacity of motor	
P03	(Rated current)	0.00 to 100.0	0.01	A	N	Y1 Y2	Rated value of Fuji standard motor	
P04	(Auto-tuning)	0: Disable 1: Enable (Tune %R1 and %X while the motor is stopped.) 2: Enable (Tune %R1, %X and rated slip while the motor is stopped, and no-load current while running.)	—	—	N	N	0	
P05	(Online tuning)	0: Disable 1: Enable	—	—	Y	Y	0	
P06	(No-load current)	0.00 to 50.00	0.01	A	N	Y1 Y2	Rated value of Fuji standard motor	9-78
P07	(%R1)	0.00 to 50.00	0.01	%	Y	Y1 Y2	Rated value of Fuji standard motor	
P08	(%X)	0.00 to 50.00	0.01	%	Y	Y1 Y2	Rated value of Fuji standard motor	
P09	(Slip compensation gain for driving)	0.0 to 200.0	0.01	%	Y*	Y	100.0	9-78
P10	(Slip compensation response time)	0.01 to 10.00	0.01	s	Y	Y1 Y2	0.50	9-79
P11	(Slip compensation gain for braking)	0.0 to 200.0	0.01	%	Y*	Y	100.0	
P12	(Rated slip frequency)	0.00 to 15.00	0.01	Hz	N	Y1 Y2	Rated value of Fuji standard motor	9-79
P99	Motor 1 Selection	0: Motor characteristics 0 (Fuji standard motors, 8-series) 1: Motor characteristics 1 (HP rating motors) 3: Motor characteristics 3 (Fuji standard motors, 6-series) 4: Other motors	—	—	N	Y1 Y2	0	

*1 When you make settings from the keypad, the incremental unit is restricted by the number of digits that the LED monitor can display.

(Example) If the setting range is from -200.00 to 200.00, the incremental unit is:

"1" for -200 to -100, "0.1" for -99.9 to -10.0 and for 100.0 to 200.0, and "0.01" for -9.99 to -0.01 and for 0.00 to 99.99.

H codes: High Performance Functions

Code	Name	Data setting range	Increment	Unit	Change when running	Data copying	Default setting	Refer to page:
H03	Data Initialization	0: Disable initialization 1: Initialize all function code data to the factory defaults 2: Initialize motor 1 parameters 3: Initialize motor 2 parameters	—	—	N	N	0	9-80
H04	Auto-reset (Times)	0: Disable 1 to 10	1	times	Y	Y	0	9-84
H05	(Reset interval)	0.5 to 20.0	0.1	s	Y	Y	5.0	
H06	Cooling Fan ON/OFF Control	0: Disable (Always in operation) 1: Enable (ON/OFF controllable)	—	—	Y	Y	0	9-85
H07	Acceleration/Deceleration Pattern	0: Linear 1: S-curve (Weak) 2: S-curve (Strong) 3: Curvilinear	—	—	Y	Y	0	9-86
H08	Rotational Direction Limitation	0: Disable 1: Enable (Reverse rotation inhibited) 2: Enable (Forward rotation inhibited)	—	—	N	Y	0	9-87
H09	Starting Mode (Auto search)	0: Disable 1: Enable (At restart after momentary power failure) 2: Enable (At restart after momentary power failure and at normal start)	—	—	N	Y	0	9-88
H11	Deceleration Mode	0: Normal deceleration 1: Coast-to-stop	—	—	Y	Y	0	9-90
H12	Instantaneous Overcurrent Limiting (Mode selection)	0: Disable 1: Enable	—	—	Y	Y	1	
H13	Restart Mode after Momentary Power Failure (Restart time)	0.1 to 10.0	0.1	s	Y	Y1 Y2	Depending on the inverter capacity	9-24 9-91
H14	(Frequency fall rate)	0.00: Deceleration time selected by F08 0.01 to 100.00 999: Follow the current limit command	0.01	Hz/s	Y	Y	999	
H16	(Allowable momentary power failure time)	0.0 to 30.0 999: Automatically determined by inverter	0.1	s	Y	Y	999	
H26	Thermistor (Mode selection)	0: Disable 1: Enable (With PTC, the inverter immediately trips with \overline{OH} displayed.)	—	—	Y	Y	0	9-91
H27	(Level)	0.00 to 5.00	0.01	V	Y	Y	1.60	
H28	Droop Control	-60.0 to 0.0	0.1	Hz	Y	Y	0.0	9-92
H30	Communications Link Function (Mode selection)	Frequency command Run command 0: F01/C30 F02 1: RS-485 F02 2: F01/C30 RS-485 3: RS-485 RS-485 4: RS-485 (option) F02 5: RS-485 (option) RS-485 6: F01/C30 RS-485 (option) 7: RS-485 RS-485 (option) 8: RS-485 (option) RS-485 (option)	—	—	Y	Y	0	9-93
H42	Capacitance of DC Link Bus Capacitor	Indication for replacing DC link bus capacitor (0000 to FFFF: Hexadecimal)	1	—	Y	N	—	9-94
H43	Cumulative Run Time of Cooling Fan	Indication of cumulative run time of cooling fan for replacement	—	—	Y	N	—	
H44	Startup Times of Motor 1	Indication of cumulative startup times	—	—	Y	N	—	
H45	Mock Alarm	0: Disable 1: Enable (Once a mock alarm occurs, the data automatically returns to 0.)	—	—	Y	N	0	9-95 9-99
H47	Initial Capacitance of DC Link Bus Capacitor	Indication for replacing DC link bus capacitor (0000 to FFFF: Hexadecimal)	—	—	Y	N	Set at factory shipping	9-95
H48	Cumulative Run Time of Capacitors on Printed Circuit Boards	Indication for replacing capacitors on printed circuit boards (0000 to FFFF: Hexadecimal). Resettable.	—	—	Y	N	—	
H49	Starting Mode (Delay time)	0.0 to 10.0 s	0.1	s	Y	Y	0.0	9-88 9-95
H50	Non-linear V/f Pattern 1 (Frequency)	0.0: Cancel 0.1 to 400.0	0.1	Hz	N	Y	0.0	9-16 9-95
H51	(Voltage)	0 to 240: Output an AVR-controlled voltage (for 230 V) 0 to 500: Output an AVR-controlled voltage (for 460 V)	1	V	N	Y2	0	
H52	Non-linear V/f Pattern 2 (Frequency)	0.0: Cancel 0.1 to 400.0	0.1	Hz	N	Y	0.0	
H53	(Voltage)	0 to 240: Output an AVR-controlled voltage (for 230 V) 0 to 500: Output an AVR-controlled voltage (for 460 V)	1	V	N	Y2	0	
H54	ACC/DEC Time (Jogging operation)	0.00 to 3600 *ACC time and DEC time are common.	0.01	s	Y	Y	6.00	9-95
H56	Deceleration Time for Forced Stop	0.00 to 3600	0.01	s	Y	Y	6.00	9-96
H61	UP/DOWN Control (Initial frequency setting)	0: 0.00 1: Last UP/DOWN command value on releasing run command	—	—	N	Y	1	
H63	Low Limiter (Mode selection)	0: Limit by F16 (Frequency limiter: Low) and continue to run 1: If the output frequency lowers below the one limited by F16 (Frequency limiter: Low), decelerate to stop the motor.	—	—	Y	Y	0	9-28 9-96
H64	(Lower limiting frequency)	0.0 (Depends on F16 (Frequency limiter: Low)) 0.1 to 60.0	0.1	Hz	Y	Y	1.6	9-96

(H code continued)

Code	Name	Data setting range	Increment	Unit	Change when running	Data copying	Default setting	Refer to page:	
H68	Slip Compensation 1 (Operating conditions)	0: Enable during ACC/DEC and enable at base frequency or above 1: Disable during ACC/DEC and enable at base frequency or above 2: Enable during ACC/DEC and disable at base frequency or above 3: Disable during ACC/DEC and disable at base frequency or above	—	—	N	Y	0	9-37 9-96	
H69	Automatic Deceleration (Mode selection)	0: Disable 2: Enable (Canceled if actual deceleration time exceeds three times the one specified by F08/E11.) 4: Enable (Not canceled if actual deceleration time exceeds three times the one specified by F08/E11.)	—	—	Y	Y	0	9-97	
H70	Overload Prevention Control	0.00 : Follow deceleration time specified by F08/E11 0.01 to 100.0 999: Disable	0.01	Hz/s	Y	Y	999		
H71	Deceleration Characteristics	0: Disable 1: Enable	—	—	Y	Y	0	9-98	
H76	Torque Limiter (Frequency increment limit for braking)	0.0 to 400.0	0.1	Hz	Y	Y	5.0	9-97 9-98	
H80	Output Current Fluctuation Damping Gain for Motor 1	0.00 to 0.40	0.01	—	Y	Y	0.20	9-98	
H89	Reserved *2	0, 1	—	—	Y	Y	0		
H90	Reserved *2	0, 1	—	—	Y	Y	0		
H91	Reserved *2	0, 1	—	—	Y	Y	0.0		
H94	Cumulative Motor Run Time 1	Change or reset the cumulative data							
H95	DC Braking (Braking response mode)	0: Slow 1: Quick	—	—	Y	Y	1	9-32 9-98	
H96	STOP Key Priority/Start Check Function	Data STOP key priority Start check function 0: Disable Disable 1: Enable Disable 2: Disable Enable 3: Enable Enable	—	—	Y	Y	0	9-99	
H97	Clear Alarm Data	0: Does not clear alarm data 1: Clear alarm data and return to zero	—	—	Y	N	0	9-95 9-99	
H98	Protection/Maintenance Function (Mode selection)	0 to 31: Display data on the keypad's LED monitor in decimal format (In each bit, "0" for disabled, "1" for enabled.) Bit 0: Lower the carrier frequency automatically Bit 1: Detect input phase loss Bit 2: Detect output phase loss Bit 3: Select life judgment threshold of DC link bus capacitor Bit 4: Judge the life of DC link bus capacitor	—	—	Y	Y	19 (bit4, 1,0=1)	9-99	

A codes: Motor 2 Parameters

Code	Name	Data setting range	Increment	Unit	Change when running	Data copying	Default setting	Refer to page:
A01	Maximum Frequency 2	25.0 to 400.0	0.1	Hz	N	Y	60.0	9-102
A02	Base Frequency 2	25.0 to 400.0	0.1	Hz	N	Y	60.0	
A03	Rated Voltage at Base Frequency 2	0: Output a voltage in proportion to input voltage 80 to 240: Output an AVR-controlled voltage (for 230 V) 160 to 500: Output an AVR-controlled voltage (for 460 V)	1	V	N	Y2	230 460	
A04	Maximum Output Voltage 2	80 to 240V: Output an AVR-controlled voltage (for 230 V) 160 to 500V: Output an AVR-controlled voltage (for 460 V)	1	V	N	Y2	230 460	
A05	Torque Boost 2	0.0 to 20.0 (percentage with respect to "A03: Rated Voltage at Base Frequency 2") Note: This setting takes effect when A13 = 0, 1, 3, or 4.	0.1	%	Y	Y	Depending on the inverter capacity	
A06	Electronic Thermal Overload Protection for Motor 2 (Select motor characteristics)	1: For a general-purpose motor with shaft-driven cooling fan 2: For an inverter-driven motor, non-ventilated motor, or motor with separately powered cooling fan	—	—	Y	Y	1	
A07	(Overload detection level)	0.00: Disable 1 to 135% of the rated current (allowable continuous drive current) of the motor	0.01	A	Y	Y1 Y2	100% of the motor rated	
A08	(Thermal time constant)	0.5 to 75.0	0.1	min	Y	Y	5.0	
A09	DC Braking 2 (Braking starting frequency)	0.0 to 60.0Hz	0.1	Hz	Y	Y	0.0	
A10	(Braking level)	0 to 100	1	%	Y	Y	0	
A11	(Braking time)	0.00 : Disable 0.01 to 30.00	0.01	s	Y	Y	0.00	
A12	Starting Frequency 2	0.1 to 60.0	0.1	Hz	Y	Y	0.5	
A13	Load Selection/ Auto Torque Boost/ Auto Energy Saving Operation 2	0: Variable torque load 1: Constant torque load 2: Auto-torque boost 3: Auto-energy saving operation (Variable torque load during ACC/DEC) 4: Auto-energy saving operation (Constant torque load during ACC/DEC) 5: Auto-energy saving operation (Auto-torque boost during ACC/DEC)	—	—	N	Y	1	

*2 These function codes and their data are displayed, but they are reserved for particular manufacturers. Unless otherwise specified, do not access these function codes.

(A code continued)

Code	Name	Data setting range	Increment	Unit	Change when running	Data copying	Default setting	Refer to page:
A14	Control Mode Selection 2	0: V/f operation with slip compensation inactive 1: Dynamic torque vector operation 2: V/f operation with slip compensation active 3: V/f operation with optional PG interface 4: Dynamic torque vector operation with optional PG interface	—	—	N	Y	0	9-102
A15	Motor 2 (No. of poles)	2 to 22	2	poles	N	Y1 Y2	4	
A16	(Rated capacity)	0.01 to 30.00 (where, P99 data is 0, 3, or 4.) 0.01 to 30.00 (where, P99 data is 1.)	0.01 0.01	kW HP	N	Y1 Y2	Rated capacity of motor	
A17	(Rated current)	0.00 to 100.0	0.01	A	N	Y1 Y2	Rated value of Fuji standard motor	
A18	(Auto-tuning)	0: Disable 1: Enable (Tune %R1 and %X while the motor is stopped.) 2: Enable (Tune %R1, %X and rated slip while the motor is stopped, and no-load current while running.)	—	—	N	N	0	
A19	(Online tuning)	0: Disable 1: Enable	—	—	Y	Y	0	
A20	(No-load current)	0.00 to 50.00	0.01	A	N	Y1 Y2	Rated value of Fuji standard motor	
A21	(%R1)	0.00 to 50.00	0.01	%	Y	Y1 Y2	Rated value of Fuji standard motor	
A22	(%X)	0.00 to 50.00	0.01	%	Y	Y1 Y2	Rated value of Fuji standard motor	
A23	(Slip compensation gain for driving)	0.0 to 200.0	0.01	%	Y*	Y	100.0	
A24	(Slip compensation response time)	0.01 to 10.00	0.01	s	Y	Y1	0.50	9-103
A25	(Slip compensation gain for braking)	0.0 to 200.0	0.01	%	Y*	Y	100.0	
A26	(Rated slip frequency)	0.00 to 15.00	0.01	Hz	N	Y1 Y2	Rated value of Fuji standard motor	
A39	Motor 2 Selection	0: Motor characteristics 0 (Fuji standard motors, 8-series) 1: Motor characteristics 1 (HP rating motors) 3: Motor characteristics 3 (Fuji standard motors, 6-series) 4: Other motors	—	—	N	Y1 Y2	0	
A40	Slip Compensation 2 (Operating conditions)	0: Enable during ACC/DEC and enable at base frequency or above 1: Disable during ACC/DEC and enable at base frequency or above 2: Enable during ACC/DEC and disable at base frequency or above 3: Disable during ACC/DEC and disable at base frequency or above	—	—	N	Y	0	
A41	Output Current Fluctuation Damping Gain for Motor 2	0.00 to 0.40	0.01	—	Y	Y	0.20	
A45	Cumulative Motor Run Time 2	Change or reset the cumulative data	—	—	N	N	—	
A46	Startup Times of Motor 2	Indication of cumulative startup times	—	—	Y	N	—	

J codes: Application Functions

Code	Name	Data setting range	Increment	Unit	Change when running	Data copying	Default setting	Refer to page:
J01	PID Control (Mode selection)	0: Disable 1: Enable (Process control, normal operation) 2: Enable (Process control, inverse operation) 3: Enable (Dancer control)	—	—	N	Y	0	9-104
J02	(Remote command SV)	0: UP/DOWN keys on keypad 1: PID command 1 3: Terminal command UP/DOWN control 4: Command via communications link	—	—	N	Y	0	
J03	P (Gain)	0.000 to 30.000 *1	0.001	times	Y	Y	0.100	
J04	I (Integral time)	0.0 to 3600.0 *1	0.1	s	Y	Y	0.0	
J05	D (Differential time)	0.00 to 600.00 *1	0.01	s	Y	Y	0.00	
J06	(Feedback filter)	0.0 to 900.0	0.1	s	Y	Y	0.5	
J10	(Anti reset windup)	0 to 200	1	%	Y	Y	200	9-112
J11	(Select alarm output)	0: Absolute-value alarm 1: Absolute-value alarm (with Hold) 2: Absolute-value alarm (with Latch) 3: Absolute-value alarm (with Hold and Latch) 4: Deviation alarm 5: Deviation alarm (with Hold) 6: Deviation alarm (with Latch) 7: Deviation alarm (with Hold and Latch)	—	—	Y	Y	0	
J12	(Upper level alarm (AH))	-100 to 100	1	%	Y	Y	100	
J13	(Lower level alarm (AL))	-100 to 100	1	%	Y	Y	0	
J18	(Upper limit of PID process output)	-150 to 150 999: The F15 data applies.	1	%	Y	Y	999	9-114
J19	(Lower limit of PID process output)	-150 to 150 999: The F16 data applies.	1	%	Y	Y	999	
J56	(Speed command filter)	0.00 to 5.00	0.01	s	Y	Y	0.10	
J57	(Dancer reference position)	-100 to 100	1	%	Y	Y	0	
J58	(Detection width of dancer position deviation)	0: Disable switching PID constant 1 to 100	1	%	Y	Y	0	
J59	P (Gain) 2	0.000 to 30.00 *1	0.001	times	Y	Y	0.100	
J60	I (Integral time) 2	0.0 to 3600.0 *1	0.1	s	Y	Y	0.0	
J61	D (Differential time) 2	0.00 to 600.00 *1	0.01	s	Y	Y	0.00	
J62	(PID control block selection)	Bit 0: PID output pole 0 = addition, 1 = subtraction Bit 1: Select compensation of output ratio 0 = speed command, 1 = ratio	1	—	N	Y	0	9-115
J63	Overload Stop (Detection value)	0: Torque 1: Current	—	—	Y	Y	0	
J64	(Detection level)	20 to 200	0.1	%	Y	Y	100	
J65	(Mode selection)	0: Disable 1: Decelerate to stop 2: Coast to a stop 3: Hit mechanical stop	—	—	N	Y	0	
J66	(Operation condition)	0: Enable at constant speed and during deceleration 1: Enable at constant speed 2: Enable anytime	—	—	Y	Y	0	
J67	(Timer)	0.00 to 600.00	0.01	s	Y	Y	0	
J68	Braking Signal (Brake OFF current)	0 to 200	1	%	Y	Y	100	9-117
J69	(Brake OFF frequency)	0.0 to 25.0	0.1	Hz	Y	Y	1.0	
J70	(Brake OFF timer)	0.0 to 5.0	0.1	s	Y	Y	1.0	
J71	(Brake ON frequency)	0.0 to 25.0	0.1	Hz	Y	Y	1.0	
J72	(Brake ON timer)	0.0 to 5.0	0.1	s	Y	Y	1.0	
J73	Positioning Control (Start timer) *2	0.0 to 1000.0	0.1	s	Y	Y	0.0	9-118
J74	(Start point; upper digits) *2	-999 to 999	1	p	Y	Y	0	
J75	(Start point; lower digits) *2	[P], 0 to 9999 *4	1	p	Y	Y	0	
J76	(Preset point; upper digits) *2	-999 to 999	1	p	Y	Y	0	
J77	(Preset point; lower digits) *2	[P], 0 to 9999 *4	1	p	Y	Y	0	
J78	(Creep speed SW point; upper digits) *2	0 to 999	1	p	Y	Y	0	
J79	(Creep speed SW point; lower digits) *2	0 to 9999	1	p	Y	Y	0	
J80	(Creep speed) *2	0 to 400	1	Hz	Y	Y	0	
J81	(End point; upper digits) *2	-999 to 999	1	p	Y	Y	0	
J82	(End point; lower digits) *2	0 to 9999	1	p	Y	Y	0	
J83	(Positioning allowance) *2	0 to 9999	1	p	Y	Y	0	
J84	(End timer) *2	0.0 to 1000.0	0.1	s	Y	Y	0.0	
J85	(Coasting compensation) *2	0 to 9999	1	p	Y	Y	0	
J86	(End point command) *2	0, 1	—	—	Y	Y	0	
J87	(Preset positioning requirement) *2	0, 1, 2	—	—	N	Y	0	
J88	(Position detection direction) *2	0, 1	—	—	N	Y	0	
J90	Overload Stop Function P (Gain) *2	0.000 to 2.000, 999	0.001	—	Y	Y	999	
J91	I (Integral time) *2	0.001 to 9.999, 999	0.001	s	Y	Y	999	
J92	(Level adjustment) *2	50.0 to 150.0	0.1	%	Y	Y	100.0	

*1 When you make settings from the keypad, the incremental unit is restricted by the number of digits that the LED monitor can display.

(Example) If the setting range is from -200.00 to 200.00, the incremental unit is:
"1" for -200 to -100, "0.1" for -99.9 to -10.0 and for 100.0 to 200.0, and "0.01" for -9.99 to -0.01 and for 0.00 to 99.99.

*2 These are available on inverters with inverter's ROM version 0700 or later. (For the version checking procedure, refer to Chapter 3, Section 3.3.6 "Reading maintenance information.")

*3 These function codes are for use with an optional multi-function keypad.

*4 [P]: Current position (Absolute position)

y codes: Link Functions

Code	Name	Data setting range	Increment	Unit	Change when running	Data copying	Default setting	Refer to page:
y01	RS-485 Communication (Standard) (Station address)	1 to 255	1	—	N	Y	1	9-119
y02	(Communications error processing)	0: Immediately trip with alarm $E-B$ 1: Trip with alarm $E-B$ after running for the period specified by timer y03 2: Retry during the period specified by timer y03. If the retry fails, trip with alarm $E-B$. If it succeeds, continue to run. 3: Continue to run	—	—	Y	Y	0	
y03	(Timer)	0.0 to 60.0	0.1	s	Y	Y	2.0	
y04	(Baud rate)	0: 2400 bps 1: 4800 bps 2: 9600 bps 3: 19200 bps 4: 38400 bps	—	—	Y	Y	3	
y05	(Data length)	0: 8 bits 1: 7 bits	—	—	Y	Y	0	
y06	(Parity check)	0: None (2 stop bits for Modbus RTU) 1: Even parity (1 stop bit for Modbus RTU) 2: Odd parity (1 stop bit for Modbus RTU) 3: None (1 stop bit for Modbus RTU)	—	—	Y	Y	0	
y07	(Stop bits)	0: 2 bits 1: 1 bit	—	—	Y	Y	0	
y08	(No-response error detection time)	0: No detection 1 to 60	1	s	Y	Y	0	
y09	(Response interval)	0.00 to 1.00	0.01	s	Y	Y	0.01	
y10	(Protocol selection)	0: Modbus RTU protocol 1: FRENIC Loader protocol (SX protocol) 2: Fuji general-purpose inverter protocol	—	—	Y	Y	1	
y11	RS-485 Communication (Option) (Station address)	1 to 255	1	—	N	Y	1	9-119
y12	(Communications error processing)	0: Immediately trip with alarm $E-P$ 1: Trip with alarm $E-P$ after running for the period specified by timer y13 2: Retry during the period specified by timer y13. If the retry fails, trip with alarm $E-P$. If it succeeds, continue to run. 3: Continue to run	—	—	Y	Y	0	
y13	(Timer)	0.0 to 60.0	0.1	s	Y	Y	2.0	
y14	(Baud rate)	0: 2400 bps 1: 4800 bps 2: 9600 bps 3: 19200 bps 4: 38400 bps	—	—	Y	Y	3	
y15	(Data length)	0: 8 bits 1: 7 bits	—	—	Y	Y	0	
y16	(Parity check)	0: None (2 stop bits for Modbus RTU) 1: Even parity (1 stop bit for Modbus RTU) 2: Odd parity (1 stop bit for Modbus RTU) 3: None (1 stop bit for Modbus RTU)	—	—	Y	Y	0	
y17	(Stop bits)	0: 2 bits 1: 1 bit	—	—	Y	Y	0	
y18	(No-response error detection time)	0: No detection 1 to 60	1	s	Y	Y	0	
y19	(Response interval)	0.00 to 1.00	0.01	s	Y	Y	0.01	
y20	(Protocol selection)	0: Modbus RTU protocol 2: Fuji general-purpose inverter protocol	—	—	Y	Y	0	
y98	Bus Link Function (Mode selection)	Frequency command Run command 0: Follow H30 data Follow H30 data 1: Via field bus option Follow H30 data 2: Follow H30 data Via field bus option 3: Via field bus option Via field bus option	—	—	Y	Y	0	9-93 9-123
y99	Loader Link Function (Mode selection)	Frequency command Run command 0: Follow H30 and y98 data Follow H30 and y98 data 1: Via RS-485 link (Loader) Follow H30 and y98 data 2: Follow H30 and y98 data Via RS-485 link (Loader) 3: Via RS-485 link (Loader) Via RS-485 link (Loader)	—	—	Y	N	0	9-123

9.2 Overview of Function Codes

This section provides a detailed description of the function codes available for the FRENIC-Multi series of inverters. In each code group, its function codes are arranged in an ascending order of the identifying numbers for ease of access. Note that function codes closely related each other for the implementation of an inverter's operation are detailed in the description of the function code having the youngest identifying number. Those related function codes are indicated in the right end of the title bar.

9.2.1 F codes (Fundamental functions)

F00	Data Protection
------------	------------------------

F00 specifies whether to protect function code data (except F00) and digital reference data (such as frequency command, PID command and timer operation) from accidentally getting changed by pressing the \triangleleft / \triangleright keys.

Data for F00	Function
0	Disable both data protection and digital reference protection, allowing you to change both function code data and digital reference data with the \triangleleft / \triangleright keys.
1	Enable data protection and disable digital reference protection, allowing you to change digital reference data with the \triangleleft / \triangleright keys. But you cannot change function code data (except F00).
2	Disable data protection and enable digital reference protection, allowing you to change function code data with the \triangleleft / \triangleright keys. But you cannot change digital reference data.
3	Enable both data protection and digital reference protection, not allowing you to change function code data or digital reference data with the \triangleleft / \triangleright keys.

Enabling the protection disables the \triangleleft / \triangleright keys to change function code data.

To change F00 data, simultaneous keying of $\text{STOP} + \triangleleft$ (from 0 to 1) or $\text{STOP} + \triangleright$ (from 1 to 0) keys is required.

 Even when F00 = 1 or 3, function code data can be changed via the communications link.



For similar purposes, **WE-KP**, a signal enabling editing of function code data from the keypad is provided as a terminal command for digital input terminals. (Refer to the descriptions of E01 through E05.)

F01	Frequency Command 1	C30 (Frequency Command 2)
------------	----------------------------	----------------------------------

F01 or C30 sets the source that specifies reference frequency 1 or reference frequency 2, respectively.







Data for F01, C30	Function
0	Enable \triangleleft / \triangleright keys on the keypad. (Refer to Chapter 3 "OPERATION USING THE KEYPAD.")
1	Enable the voltage input to terminal [12] (0 to ± 10 VDC, maximum frequency obtained at ± 10 VDC).
2	Enable the current input to terminal [C1] (C1 function) (+4 to +20 mA DC, maximum frequency obtained at +20 mA DC).

Data for F01, C30	Function
3	Enable the sum of voltage (0 to +10 VDC) and current inputs (+4 to +20 mA DC) given to terminals [12] and [C1] (C1 function), respectively. See the two items listed above for the setting range and the value required for maximum frequencies. Note: If the sum exceeds the maximum frequency (F03/A01), the maximum frequency will apply.
5	Enable the voltage input to terminal [C1] (V2 function) (0 to +10 VDC, maximum frequency obtained at 10 VDC).
7	Enable UP and DOWN commands assigned to the digital input terminals. The UP command (data = 17) and DOWN command (data = 18) should be assigned to the digital input terminals [X1] to [X5].
11	Enable the digital input of the binary coded decimal (BCD) code or binary data entered via the DIO interface card (option). For details, refer to the DIO Interface Card Instruction Manual.
12	Enable the pulse train entered via the PG interface card (option). For details, refer to the PG Interface Card Instruction Manual.

- 
To input bipolar analog voltage (0 to ±10 VDC) to terminal [12], set function code C35 to "0." Setting C35 to "1" enables the voltage range from 0 to +10 VDC and interprets the negative polarity input from 0 to -10 VDC as 0 V.
- Terminal [C1] can be used for current input (C1 function) or voltage input (V2 function) depending upon the settings of switch SW7 on the interface PCB and function code E59.
- In addition to the frequency command sources described above, higher priority command sources including communications link and multi-frequency are provided.
- 
Using the terminal command **H_z2/H_z1** assigned to one of the digital input terminals switches between frequency command 1 (F01) and frequency command 2 (C30). Refer to function codes E01 to E05.

F02	Operation Method
------------	-------------------------

F02 selects the source that specifies a run command for running the motor.

Data for F02	Run Command Source	Description
0	Keypad (Rotation direction specified by terminal command)	Enables the  /  keys to run and stop the motor. The rotation direction of the motor is specified by terminal command FWD or REV .
1	External signal	Enables terminal command FWD or REV to run the motor.
2	Keypad (Forward rotation)	Enables  /  keys to run and stop the motor. Note that this run command enables only the forward rotation. There is no need to specify the rotation direction.
3	Keypad (Reverse rotation)	Enables  /  keys to run and stop the motor. Note that this run command enables only the reverse rotation. There is no need to specify the rotation direction.



- When function code F02 = 0 or 1, the "Run forward" **FWD** and "Run reverse" **REV** terminal commands must be assigned to terminals [FWD] and [REV], respectively.
- When the **FWD** or **REV** is ON, the F02 data cannot be changed.
- When assigning the **FWD** or **REV** to terminal [FWD] or [REV] with F02 being set to "1," be sure to turn the target terminal OFF beforehand; otherwise, the motor may unintentionally rotate.
- In addition to the run command sources described above, higher priority command sources including communications link are provided.

F03	Maximum Frequency 1	A01 (Maximum Frequency 2)
------------	----------------------------	----------------------------------

F03 specifies the maximum frequency to limit a reference frequency. Specifying the maximum frequency exceeding the rating of the equipment driven by the inverter may cause damage or a dangerous situation. Make sure that the maximum frequency setting matches the equipment rating.

⚠ CAUTION

The inverter can easily accept high-speed operation. When changing the speed setting, carefully check the specifications of motors or equipment beforehand.

Otherwise injuries could occur.



Modifying F03 data to allow a higher reference frequency requires also changing F15 data specifying a frequency limiter (high).

F04	Base Frequency 1	H50 (Non-linear V/f Pattern 1, Frequency) A02 (Base Frequency 2)
------------	-------------------------	---

F05	Rated Voltage at Base Frequency 1	H51 (Non-linear V/f Pattern 1, Voltage) A03 (Rated Voltage at Base Frequency 2)
------------	--	--

F06	Maximum Output Voltage 1	H52 (Non-linear V/f Pattern 2, Frequency) H53 (Non-linear V/f Pattern 2, Voltage) A04 (Maximum Output Voltage 2)
------------	---------------------------------	---

These function codes specify the base frequency and the voltage at the base frequency essentially required for running the motor properly. If combined with the related function codes H50 through H53, these function codes may profile the non-linear V/f pattern by specifying increase or decrease in voltage at any point on the V/f pattern.

The following description includes setups required for the non-linear V/f pattern.

At high frequencies, the motor impedance may increase, resulting in an insufficient output voltage and a decrease in output torque. This feature is used to increase the voltage with the maximum output voltage 1 to prevent this problem from happening. Note, however, that you cannot increase the output voltage beyond the voltage of the inverter's input power.

■ **Base Frequency 1 (F04)**

Set the rated frequency printed on the nameplate labeled on the motor.

■ **Rated Voltage at Base Frequency (F05)**

Set 0 or the rated voltage printed on the nameplate labeled on the motor.

- If 0 is set, the rated voltage at base frequency is determined by the power source of the inverter. The output voltage will vary in line with any variance in input voltage.
- If the data is set to anything other than 0, the inverter automatically keeps the output voltage constant in line with the setting. When any of the auto torque boost settings, auto energy saving or slip compensation is active, the voltage settings should be equal to the rated voltage of the motor.

■ Non-linear V/f Patterns 1 and 2 for Frequency (H50 and H52)

Set the frequency component at an arbitrary point of the non-linear V/f pattern. (Setting 0.0 to H50 or H52 disables the non-linear V/f pattern operation.)

■ Non-linear V/f Patterns 1 and 2 for Voltage (H51 and H53)

Sets the voltage component at an arbitrary point of the non-linear V/f pattern.

■ Maximum Output Voltage (F06)

Set the voltage for the maximum frequency 1 (F03).



- If F05 (Rated Voltage at Base Frequency 1) is set to "0," settings of H50 through H53 and F06 do not take effect. (When the non-linear point is below the base frequency, the linear V/f pattern applies; when it is above, the output voltage is kept constant.)
- When the auto torque boost (F37) is enabled, the non-linear V/f pattern takes no effect.

Examples:

■ Normal (linear) V/f pattern

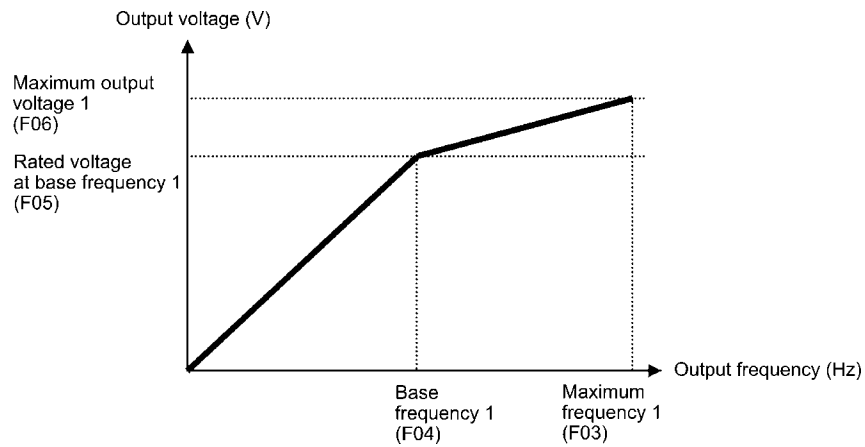

■ V/f pattern with two non-linear points

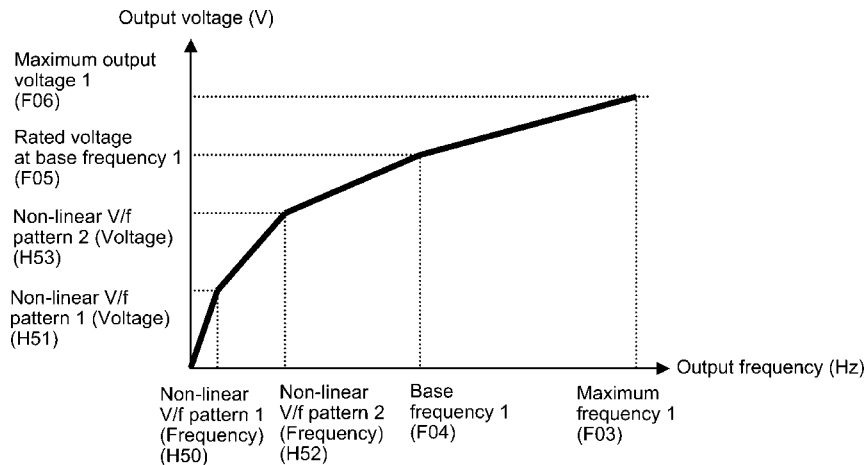

F07	Acceleration Time 1	E10 (Acceleration Time 2)
F08	Deceleration Time 1	E11 (Deceleration Time 2)

F07 specifies the acceleration time, the length of time the frequency increases from 0 Hz to the maximum frequency. F08 specifies the deceleration time, the length of time the frequency decreases from the maximum frequency down to 0 Hz.

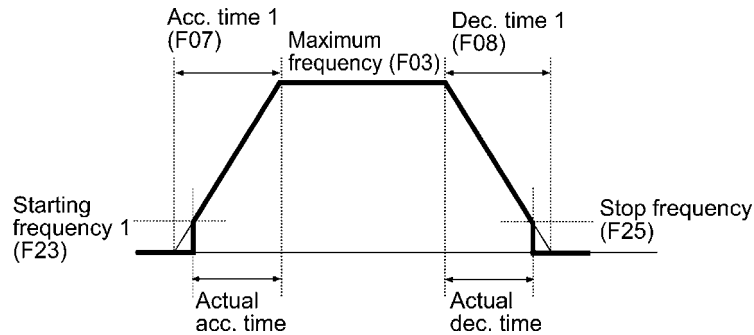

- Note**
- If you choose S-curve acceleration/deceleration or curvilinear acceleration/deceleration in Acceleration/Deceleration Pattern (H07), the actual acceleration/deceleration times are longer than the specified times. Refer to the description of H07 for details.
 - Specifying an improperly short acceleration/deceleration time may activate the current limiter, torque limiter, or anti-regenerative control, resulting in a longer acceleration/deceleration time than the specified one.
- Tip** Acceleration/deceleration time 1 (F07/F08) and acceleration/deceleration time 2 (E10/E11) are switched by terminal command **RTI** assigned to any of the digital input terminals with any of function codes E01 through E05.

F09	Torque Boost 1	F37 (Load Selection/Auto Torque Boost/Auto Energy Saving Operation 1) A05 (Torque Boost 2)
------------	-----------------------	---

F37 specifies V/f pattern, torque boost type, and auto energy saving operation for optimizing the operation in accordance with the characteristics of the load. F09 specifies the type of torque boost in order to provide sufficient starting torque.

Data for F37	V/f pattern	Torque boost (F09)	Auto energy saving	Applicable load
0	Variable torque V/f pattern	Torque boost specified by F09	Disable	Variable torque load increasing in proportion to square of speed (General purpose fans and pumps)
1	Linear V/f pattern	Auto torque boost		Constant torque load
2			Constant torque load (To be selected if a motor may be over-excited at no load.)	
3	Variable torque V/f pattern	Torque boost specified by F09	Enable	Variable torque load increasing in proportion to square of speed (General purpose fans and pumps)
4	Linear V/f pattern	Auto torque boost		Constant torque load
5				Constant torque load (To be selected if a motor may be over-excited at no load.)

Note: If a required "load torque + acceleration torque" is more than 50% of the rated torque, it is recommended to select the linear V/f pattern (factory default).

■ V/f characteristics

The FRENIC-Multi series of inverters offers a variety of V/f patterns and torque boosts, which include V/f patterns suitable for variable torque load such as general fans and pumps or for special pump load requiring high starting torque. Two types of torque boost are available: manual and automatic.

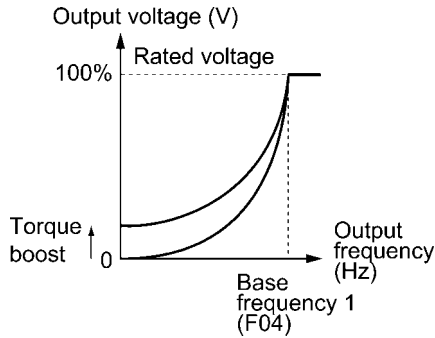

Variable torque V/f pattern (F37 = 0)

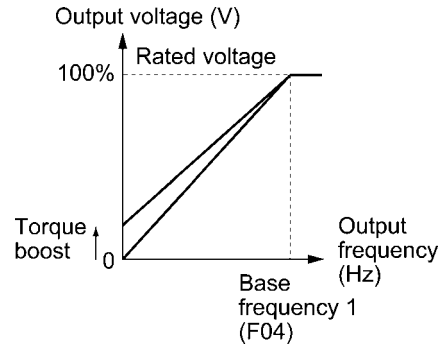

Linear V/f pattern (F37 = 1)



When the variable torque V/f pattern is selected (F37 = 0 or 3), the output voltage may be low and insufficient voltage output may result in less output torque of the motor at a low frequency zone, depending on some characteristics of the motor itself and load. In such a case, it is recommended to increase the output voltage at the low frequency zone using the non-linear V/f pattern.

Recommended value: H50 = 1/10 of the base frequency

H51 = 1/10 of the voltage at base frequency

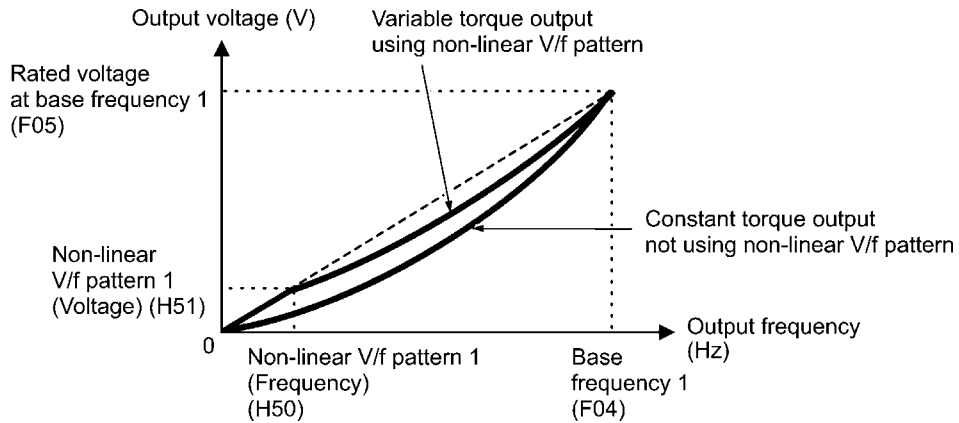

■ Torque boost

• Manual torque boost (F09)

In torque boost using F09, constant voltage is added to the basic V/f pattern, regardless of the load, to give the output voltage. To secure a sufficient starting torque, manually adjust the output voltage to optimally match the motor and its load by using F09. Specify an appropriate level that guarantees smooth start-up and yet does not cause over-excitation with no or light load.

Torque boost per F09 ensures high driving stability since the output voltage remains constant regardless of the load fluctuation.

Specify the F09 data in percentage to the rated voltage at base frequency 1 (F05). At factory shipment, F09 is preset to a level that provides approx. 100% of starting torque.

Note Specifying a high torque boost level will generate a high torque, but may cause overcurrent due to over-excitation at no load. If you continue to drive the motor, it may overheat. To avoid such a situation, adjust torque boost to an appropriate level. When the non-linear V/f pattern and the torque boost are used together, the torque boost takes effect below the frequency on the non-linear V/f pattern's point.

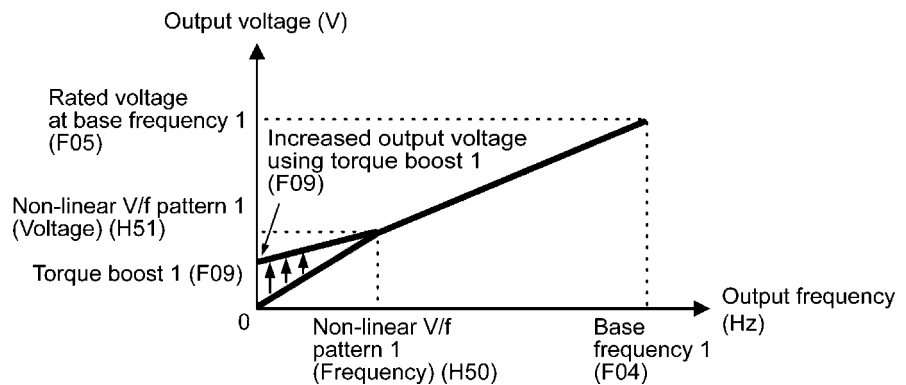

• Auto torque boost

This function automatically optimizes the output voltage to fit the motor with its load. Under light load, auto torque boost decreases the output voltage to prevent the motor from over-excitation. Under heavy load, it increases the output voltage to increase output torque of the motor.

- Note**
- Since this function relies also on the characteristics of the motor, set the base frequency 1 (F04), the rated voltage at base frequency 1 (F05), and other pertinent motor parameters (P01 through P03 and P06 through P99) in line with the motor capacity and characteristics, or else perform auto-tuning (P04).
 - When a special motor is driven or the load does not have sufficient rigidity, the maximum torque might decrease or the motor operation might become unstable. In such cases, do not use auto torque boost but choose manual torque boost per F09 (F37 = 0 or 1).

■ Auto energy saving operation

This feature automatically controls the supply voltage to the motor to minimize the total power loss of motor and inverter. (Note that this feature may not be effective depending upon the motor or load characteristics. Check the advantage of energy saving before actually apply this feature to your power system.)

This feature applies to constant speed operation only. During acceleration/deceleration, the inverter will run with manual torque boost (F09) or auto torque boost, depending on the F37 data. If auto energy saving operation is enabled, the response to a change in motor speed may be slow. Do not use this feature for such a system that requires quick acceleration/deceleration.



- Use auto energy saving only where the base frequency is 60 Hz or lower. If the base frequency is set at 60 Hz or higher, you may get a little or no energy saving advantage. The auto energy saving operation is designed for use with the frequency lower than the base frequency. If the frequency becomes higher than the base frequency, the auto energy saving operation will be invalid.
- Since this function relies also on the characteristics of the motor, set the base frequency 1 (F04), the rated voltage at base frequency 1 (F05), and other pertinent motor parameters (P01 through P03 and P06 through P99) in line with the motor capacity and characteristics, or else perform auto-tuning (P04).

F10	Electronic Thermal Overload Protection for Motor 1 (Select motor characteristics) A06 (Electronic Thermal Overload Protection for Motor 2, Select motor characteristics)
F11	Electronic Thermal Overload Protection for Motor 1 (Overload detection level) A07 (Electronic Thermal Overload Protection for Motor 2, Overload detection level)
F12	Electronic Thermal Overload Protection for Motor 1 (Thermal time constant) A08 (Electronic Thermal Overload Protection for Motor 2, Thermal time constant)

F10 through F12 specify the thermal characteristics of the motor for its electronic thermal overload protection that is used to detect overload conditions of the motor inside the inverter.

F10 selects the motor cooling mechanism to specify its characteristics, F11 specifies the overload detection current, and F12 specifies the thermal time constant.



Thermal characteristics of the motor specified by F10 and F12 are also used for the overload early warning. Even if you need only the overload early warning, set these characteristics data to these function codes. To disable the electronic thermal overload protection, set function code F11 to "0.00."

■ Select motor characteristics (F10)

F10 selects the cooling mechanism of the motor--shaft-driven or separately powered cooling fan.

Data for F10	Function
1	For a general-purpose motor with shaft-driven cooling fan (The cooling effect will decrease in low frequency operation.)
2	For an inverter-driven motor, non-ventilated motor, or motor with separately powered cooling fan (The cooling effect will be kept constant regardless of the output frequency.)

The figure below shows operating characteristics of the electronic thermal overload protection when F10 = 1. The characteristic factors $\alpha 1$ through $\alpha 3$ as well as their corresponding output frequencies $f2$ and $f3$ vary with the characteristics of the motor. The tables below list the factors of the motor selected by P99 (Motor 1 Selection).

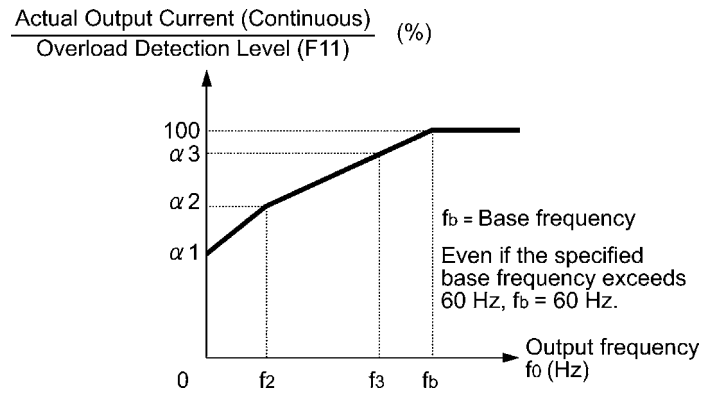

Cooling Characteristics of Motor with Shaft-driven Cooling Fan

Nominal Applied Motor and Characteristic Factors when P99 (Motor 1 Selection) = 0 or 4

Nominal applied motor (HP)	Thermal time constant τ (Factory default)	Output current for setting the thermal time constant (I_{max})	Output frequency for motor characteristic factor		Characteristic factor (%)		
			f_2	f_3	$\alpha 1$	$\alpha 2$	$\alpha 3$
1/8 to 1	5 min	Rated current $\times 150\%$	5 Hz	7 Hz	75	85	100
2 to 5					85	85	100
7.5 to 15				6 Hz	90	95	100
20				7 Hz	85	85	100
25, 30				5 Hz	92	100	100

Nominal Applied Motor and Characteristic Factors when P99 (Motor 1 Selection) = 1 or 3

Nominal applied motor (HP)	Thermal time constant τ (Factory default)	Output current for setting the thermal time constant (I_{max})	Output frequency for motor characteristic factor		Characteristic factor (%)		
			f_2	f_3	$\alpha 1$	$\alpha 2$	$\alpha 3$
1/8 to 30	5 min	Rated current $\times 150\%$	Base frequency $\times 33\%$	Base frequency $\times 33\%$	69	90	90

■ Overload detection level (F11)

F11 specifies the level at which the electronic thermal overload protection becomes activated.

In general, set F11 to the rated current of motor when driven at the base frequency (i.e. 1.0 to 1.1 multiple of the rated current of motor 1 (P03)). To disable the electronic thermal overload protection, set F11 to "0.00: Disable."

■ Thermal time constant (F12)

F12 specifies the thermal time constant of the motor. If the current of 150% of the overload detection level specified by F11 flows for the time specified by F12, the electronic thermal overload protection becomes activated to detect the motor overload. The thermal time constant for general-purpose motors including Fuji motors is approx. 5 minutes by factory default.

- Data setting range: 0.5 to 75.0 (minutes) in increments of 0.1 (minute)

(Example) When the F12 data is set at "5.0" (5 minutes)

As shown below, the electronic thermal overload protection is activated to detect an alarm condition (alarm code $\overline{L} / \overline{I}$) when the output current of 150% of the overload detection level (specified by F11) flows for 5 minutes, and 120% for approx. 12.5 minutes.

The actual driving time required for issuing a motor overload alarm tends to be shorter than the value specified as the time period from when the output current exceeds the rated current (100%) until it reaches 150% of the overload detection level.

Example of Operating Characteristics

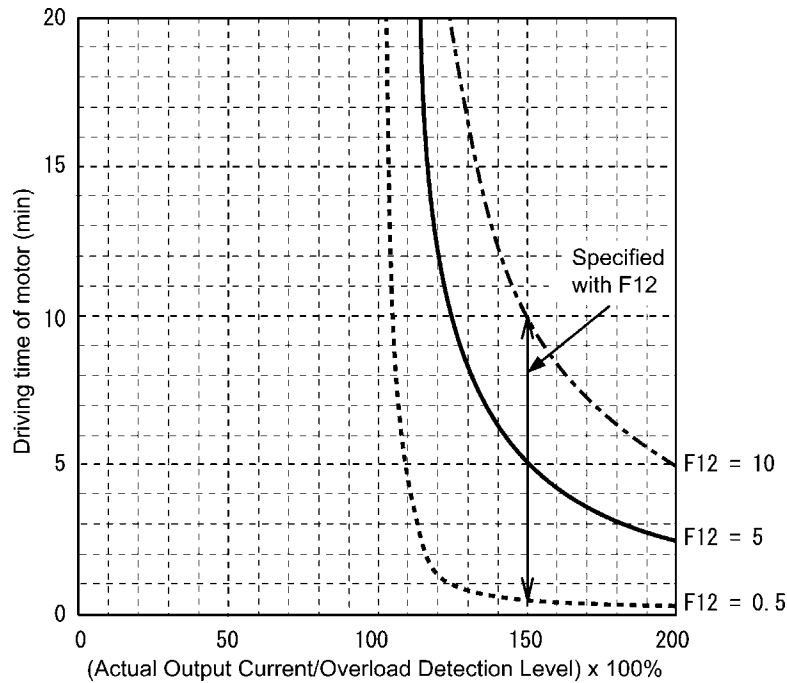

F14**Restart Mode after Momentary Power Failure (Mode selection)****H13 (Restart Mode after Momentary Power Failure, Restart time)****H14 (Restart Mode after Momentary Power Failure, Frequency fall rate)****H16 (Restart Mode after Momentary Power Failure, Allowable momentary power failure time)**

F14 specifies the action to be taken by the inverter such as trip and restart in the event of a momentary power failure.

■ Restart mode after momentary power failure (Mode selection) (F14)

Data for F14	Mode	Description
0	Disable restart (Trip immediately)	As soon as the DC link bus voltage drops below the undervoltage detection level due to a momentary power failure, the inverter issues undervoltage alarm $\angle\angle\prime$ and shuts down its output so that the motor enters a coast-to-stop state.
1	Disable restart (Trip after recovery from power failure)	As soon as the DC link bus voltage drops below the undervoltage detection level due to a momentary power failure, the inverter shuts down its output so that the motor enters a coast-to-stop state, but it does not enter the undervoltage state or issue undervoltage alarm $\angle\angle\prime$. The moment the power is restored, an undervoltage alarm $\angle\angle\prime$ is issued, while the motor remains in a coast-to-stop state.
4	Enable restart (Restart at the frequency at which the power failure occurred, for general loads)	As soon as the DC link bus voltage drops below the undervoltage detection level due to a momentary power failure, the inverter saves the output frequency being applied at that time and shuts down the output so that the motor enters a coast-to-stop state. If a run command has been input, restoring power restarts the inverter at the output frequency saved during the last power failure processing. This setting is ideal for applications with a moment of inertia large enough not to slow down the motor quickly, such as fans, even after the motor enters a coast-to-stop state upon occurrence of a momentary power failure.
5	Enable restart (Restart at the starting frequency, for low-inertia load)	After a momentary power failure, restoring power and then entering a run command restarts the inverter at the starting frequency specified by function code F23. This setting is ideal for heavy load applications such as pumps, having a small moment of inertia, in which the motor speed quickly goes down to zero as soon as it enters a coast-to-stop state upon occurrence of a momentary power failure.



When the motor restarts after a momentary power failure, the auto search mode can apply, which detects the idling motor speed and runs the idling motor without stopping it. Refer to H09.

⚠ WARNING

If you enable the "Restart mode after momentary power failure" (Function code F14 = 4 or 5), the inverter automatically restarts the motor running when the power is restored. Design the machinery or equipment so that human safety is ensured after restarting.

Otherwise an accident could occur.

■ Restart mode after momentary power failure (Basic operation)

The inverter recognizes a momentary power failure upon detecting the condition that DC link bus voltage goes below the undervoltage detection level, while the inverter is running. If the load of the motor is light and the duration of the momentary power failure is extremely short, the voltage drop may not be great enough for a momentary power failure to be recognized, and the motor may continue to run uninterrupted.

Upon recognizing a momentary power failure, the inverter enters the restart mode (after a recovery from momentary power failure) and prepares for restart. When power is restored, the inverter goes through an initial charging stage and enters the ready-to-run state. When a momentary power failure occurs, the power supply voltage for external circuits such as relay sequence circuits may also drop so as to turn the run command off. In consideration of such a situation, the inverter waits 2 seconds for a run command input after the inverter enters a ready-to-run state. If a run command is received within 2 seconds, the inverter begins the restart processing in accordance with the F14 data (Mode selection). If no run command has been received within 2-second wait period, the inverter cancels the restart mode (after a recovery from momentary power failure) and needs to be started again from the ordinary starting frequency. Therefore, ensure that a run command is entered within 2 seconds after a recovery of power, or install a mechanical latch relay.

When run commands are entered via the keypad, the above operation is also necessary for the mode (F02 = 0) in which the rotational direction is determined by the terminal command, **FWD** or **REV**. In the modes where the rotational direction is fixed (F02 = 2 or 3), it is retained inside the inverter so that the restart will begin as soon as the inverter enters the ready-to-run state.

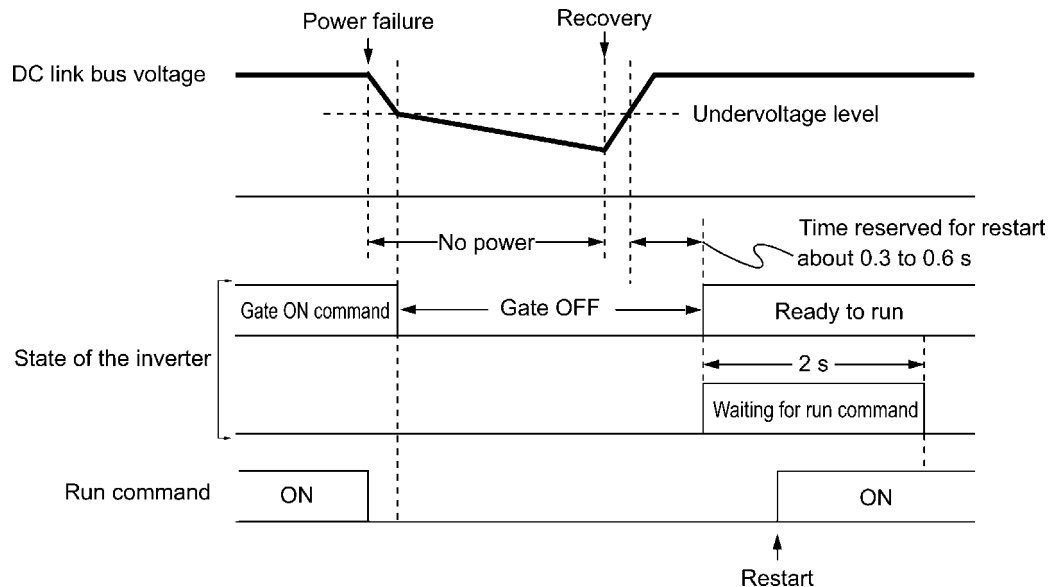

- When the power is restored, the inverter will wait 2 seconds for input of a run command. However, if the allowable momentary power failure time (H16) elapses after the power failure was recognized, even within the 2 seconds, the restart time for a run command is canceled. The inverter will start operation in the normal starting sequence.
- If the "Coast to a stop" terminal command **BX** is entered during the power failure, the inverter gets out of the restart mode and enters the normal running mode. If a run command is entered with power supply applied, the inverter will start from the normal starting frequency.

During a momentary power failure, the motor slows down. After power is restored, the inverter restarts at the frequency just before the momentary power failure. Then, the current limiting function works and the output frequency of the inverter automatically decreases. When the output frequency matches the motor speed, the motor accelerates up to the original output frequency. See the figure below. In this case, the instantaneous overcurrent limiting must be enabled (H12 = 1).

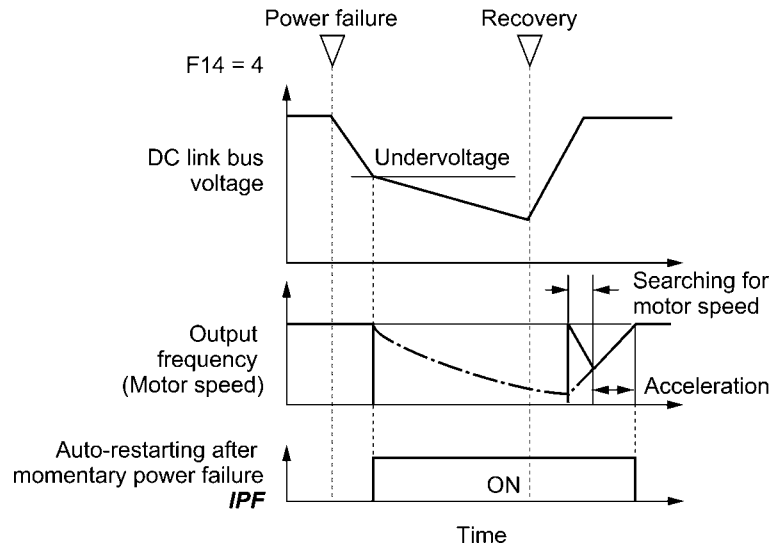

■ Restart mode after momentary power failure
(Allowable momentary power failure time) (H16)

H16 specifies the maximum allowable duration (0.0 to 30.0 seconds) from an occurrence of a momentary power failure (undervoltage) until the inverter is to be restarted. Specify the coast-to-stop time during which the machine system and facility can be tolerated.

If the power is restored within the specified duration, the inverter restarts in the restart mode specified by F14. If the power is restored after the specified duration, the inverter recognizes that the power has been shut down so that it does not restart but starts (normal starting).

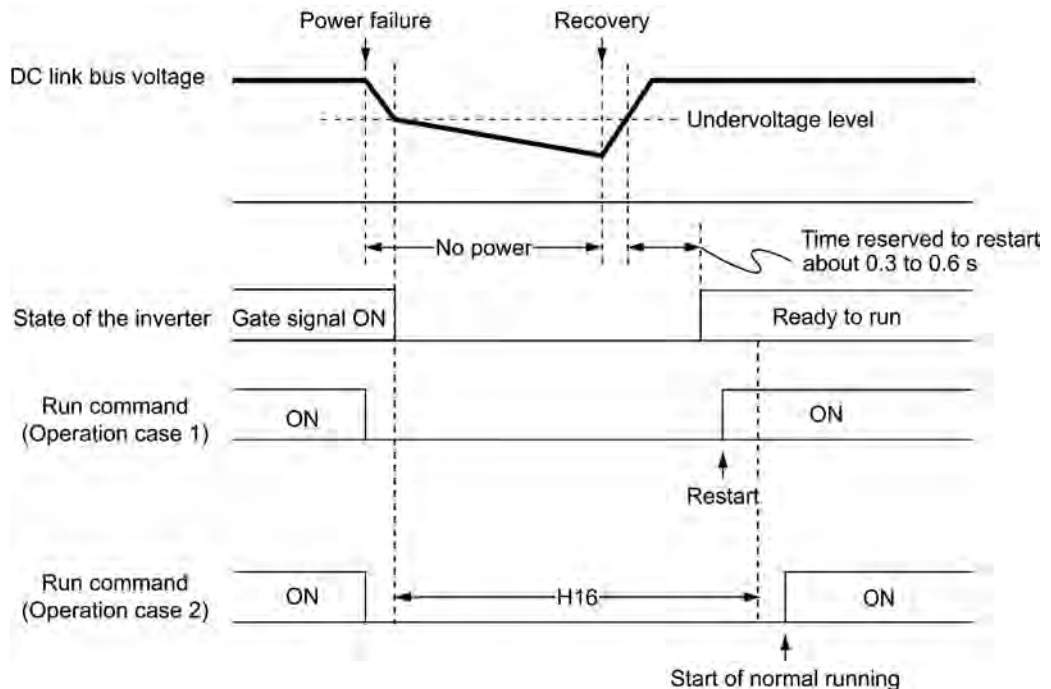

If H16 (Allowable momentary power failure time) is set to "999," restart will take place until the DC link bus voltage drops down to the allowable voltage for restart after a momentary power failure (50 V for 230 V class series and 100 V for 460 V class series). If the DC link bus voltage drops below the allowable voltage, the inverter recognizes that the power has been shut down so that it does not restart but starts (normal starting).

Note The time required from when the DC link bus voltage drops from the threshold of undervoltage until it reaches the allowable voltage for restart after a momentary power failure, greatly varies depending on the inverter capacity, the presence of options, and other factors.

■ Auto-restart after momentary power failure (Restart time) (H13)

H13 specifies the time period from momentary power failure occurrence until the inverter reacts for restarting process.

If the inverter starts the motor while motor’s residual voltage is still in a high level, a large inrush current may flow or an overvoltage alarm may occur due to an occurrence of temporary regeneration. For safety, therefore, it is advisable to set H13 to a certain level so that restart will take place only after the residual voltage has dropped to a low level. Note that even when power is restored, restart will not take place until the restart time (H13) has elapsed.

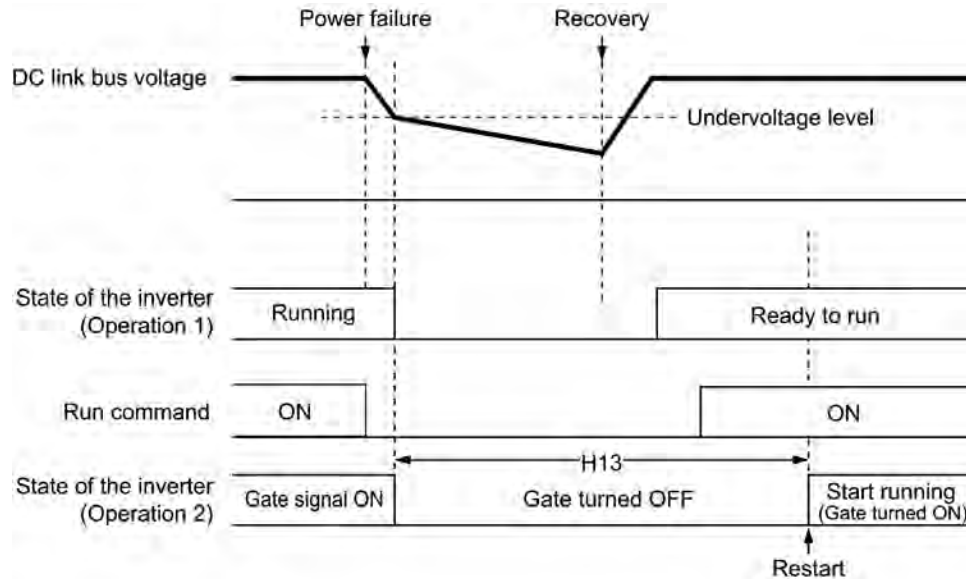

Factory default

By factory default, H13 is set at one of the values shown below according to the inverter capacity. Basically, you do not need to change H13 data. However, if the long restart time causes the flow rate of the pump to overly decrease or causes any other problem, you might as well reduce the setting to about a half of the default value. In such a case, make sure that no alarm occurs.

Inverter capacity (kW)	Factory default of H13 (Restart time in seconds)
0.1 to 7.5	0.5
11 to 15	1.0



- When you change the frequency limiter (High) (F15) in order to raise the reference frequency, be sure to change the maximum frequency (F03/A01) accordingly.

- Maintain the following relationship among the data for frequency control:

$$F15 > F16, F15 > F23/A12, \text{ and } F15 > F25$$

$$F03/A01 > F16$$

where, F23/A12 is of the starting frequency and F25 is of the stop frequency.

If you specify any wrong data for these function codes, the inverter may not run the motor at the desired speed, or cannot start it normally.

F18	Bias (Frequency command 1)	C50, C32, C34, C37, C39, C42 and C44 (Bias base point, Gain, and Gain base point)
------------	-----------------------------------	--

When any analog input for frequency command 1 (F01) is used, it is possible to define the relationship between the analog input and the reference frequency by multiplying the gain and adding the bias specified by F18.

Analog input	Gain		Bias	
	Function code	Data setting range (%)	Function code	Data setting range (%)
Terminal [12]	C32: Gain	0.00 to 200.00	F18: Bias	-100.00 to 100.00
	C34: Gain base point	0.00 to 100.00		
Terminal [C1] (C1 function)	C37: Gain	0.00 to 200.00	C50: Bias base point	0.00 to 100.00
	C39: Gain base point	0.00 to 100.00		
Terminal [C1] (V2 function)	C42: Gain	0.00 to 200.00	C50: Bias base point	0.00 to 100.00
	C44: Gain base point	0.00 to 100.00		

- In the case of unipolar input (Terminal [12] with C35 = 1, terminal [C1] (C1 function) or terminal [C1] (V2 function))

As shown in the graph below, the relationship between the analog input and the reference frequency specified by frequency command 1 is determined by points "A" and "B." Point "A" is defined by the combination of the bias (F18) and its base point (C50); Point "B," by the combination of the gain (C32, C37 or C42) and its base point (C34, C39 or C44).

The combination of C32 and C34 applies to terminal [12], that of C37 and C39, to [C1] (C1 function), and that of C42 and C44, to [C1] (V2 function).

Configure the bias (F18) and gain (C32, C37 or C42), assuming the maximum frequency as 100%, and the bias base point (C50) and gain base point (C34, C39 or C44), assuming the full scale (10 VDC or 20 mA DC) of analog input as 100%.



- The analog input less than the bias base point (C50) is limited by the bias value (F18).
- Specifying that the data of the bias base point (C50) is equal to or greater than that of each gain base point (C34, C39 or C44) will be interpreted as invalid, so the inverter will reset the reference frequency to 0 Hz.

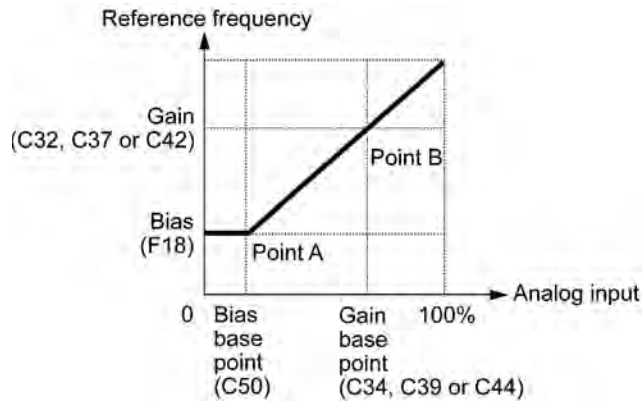

Example: Setting the bias, gain and their base points when the reference frequency 0 to 100% follows the analog input of 1 to 5 VDC to terminal [12] (in frequency command 1).

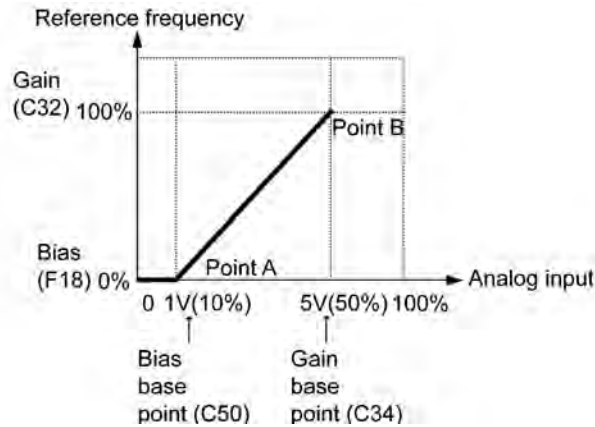

(Point A)

To set the reference frequency to 0 Hz for an analog input being at 1 V, set the bias to 0% (F18 = 0). Since 1 V is the bias base point and it is equal to 10% of 10 V (full scale), set the bias base point to 10% (C50 = 10).

(Point B)

To make the maximum frequency equal to the reference frequency for an analog input being at 5 V, set the gain to 100% (C32 = 100). Since 5 V is the gain base point and it is equal to 50% of 10 V (full scale), set the gain base point to 50% (C34 = 50).

Note The setting procedure for specifying a gain or bias alone without changing any base points is the same as that of Fuji conventional inverters of FRENIC5000G11S/P11S series, FVR-E11S series, etc.

- In the case of bipolar input (Terminal [12] with C35 = 0)

Setting C35 to "0" enables terminal [12] to be used for bipolar input (-10 V to +10 V).

When both F18 (Bias) and C50 (Bias base point) are set to "0," the negative and positive voltage inputs produce reference frequencies symmetric about the origin point as shown below.

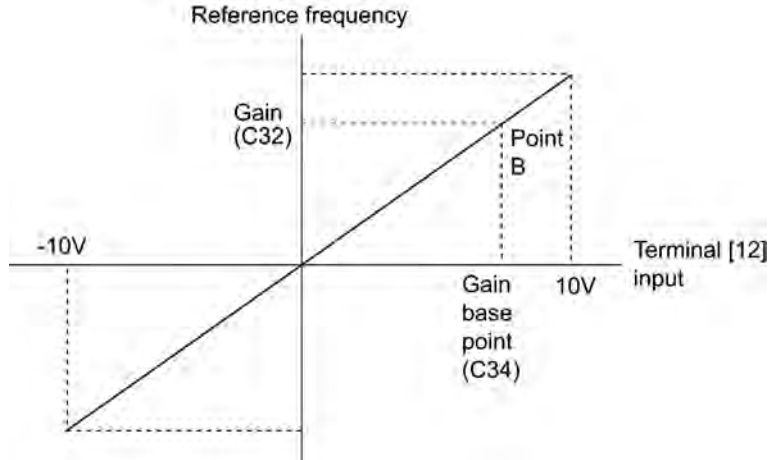

Configuring F18 (Bias) and C50 (Bias base point) to specify an arbitrary value (Points A1, A2, and A3) gives the bias as shown below.

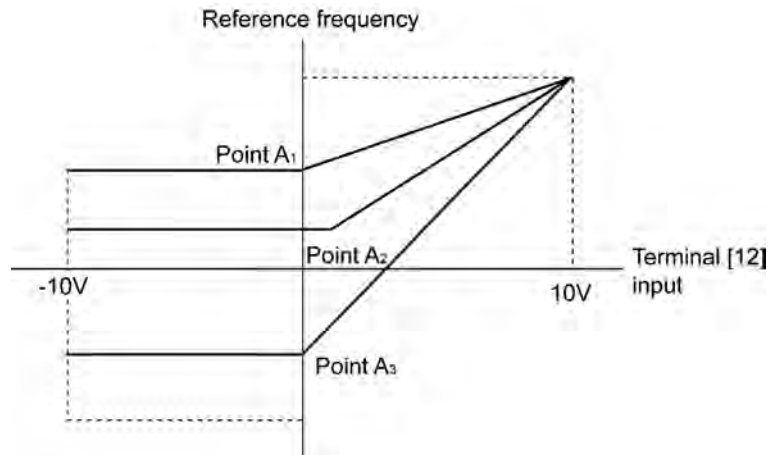



It is also possible to use an external digital input signal as an "Enable DC braking" terminal command **DCBRK**.

As long as the **DCBRK** command is ON, the inverter performs DC braking, regardless of the braking time specified by F22.

Turning the **DCBRK** command ON even when the inverter is in a stopped state activates DC braking. This feature allows the motor to be excited before starting, resulting in smoother acceleration (quicker build-up of acceleration torque).



In general, specify data of function code F20 at a value close to the rated slip frequency of motor. If you set it at an extremely high value, control may become unstable and an overvoltage alarm may result in some cases.

⚠ CAUTION
The DC brake function of the inverter does not provide any holding mechanism. Injuries could occur.

F23	Starting Frequency 1	A12 (Starting Frequency 2)
F24	Starting Frequency 1 (Holding time)	
F25	Stop Frequency	F39 (Stop Frequency, Holding time)

At the startup of an inverter, the initial output frequency is equal to the starting frequency 1 specified by F23. The inverter stops its output when the output frequency reaches the stop frequency specified by F25.

Set the starting frequency to a level at which the motor can generate enough torque for startup. Generally, set the motor's rated slip frequency as the starting frequency.

In addition, F24 specifies the holding time for the starting frequency 1 in order to compensate for the delay time for the establishment of a magnetic flux in the motor. F39 specifies the holding time for the stop frequency in order to stabilize the motor speed at the stop of the motor.



If the starting frequency is lower than the stop frequency, the inverter will not output any power as long as the reference frequency does not exceed the stop frequency.

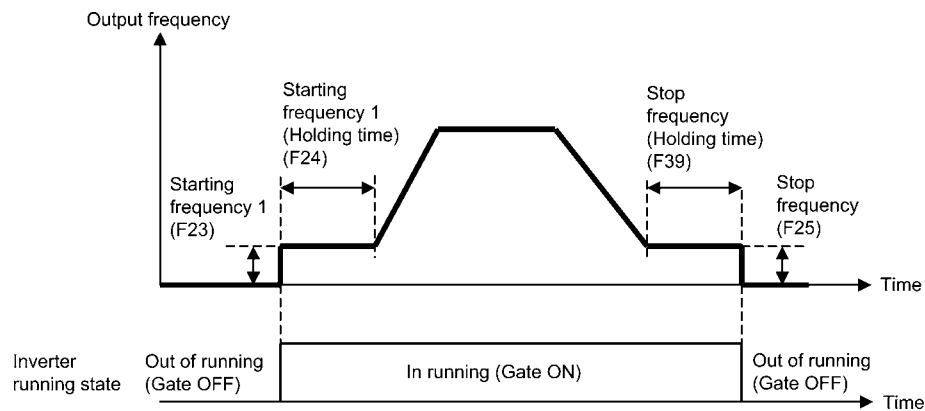



F26	Motor Sound (Carrier frequency)
F27	Motor Sound (Tone)

■ Motor sound (Carrier frequency) (F26)

F26 controls the carrier frequency so as to reduce an audible noise generated by the motor or electromagnetic noise from the inverter itself, and to decrease a leakage current from the main output (secondary) wirings.

Carrier frequency	0.75 to 15 kHz
Motor sound noise emission	High ↔ Low
Motor temperature (due to harmonics components)	High ↔ Low
Ripples in output current waveform	Large ↔ Small
Leakage current	Low ↔ High
Electromagnetic noise emission	Low ↔ High
Inverter loss	Low ↔ High

 Specifying a too low carrier frequency will cause the output current waveform to have a large amount of ripples. As a result, the motor loss increases, causing the motor temperature to rise. Furthermore, the large amount of ripples tends to cause a current limiting alarm. When the carrier frequency is set to 1 kHz or below, therefore, reduce the load so that the inverter output current comes to be 80% or less of the rated current.

When a high carrier frequency is specified, the temperature of the inverter may rise due to an ambient temperature rise or an increase of the load. If it happens, the inverter automatically decreases the carrier frequency to prevent the inverter overload alarm . With consideration for motor noise, the automatic reduction of carrier frequency can be disabled. Refer to the description of H98.

■ Motor sound (Tone) (F27)

F27 changes the motor running sound tone. This setting is effective when the carrier frequency set to function code F26 is 7 kHz or lower. Changing the tone level may reduce the high and harsh running noise from the motor.

 If the sound level is set too high, the output current may become unstable, or mechanical vibration and noise may increase. Also, these function codes may not be very effective for certain types of motor.

F29	Analog Output [FM] (Mode selection)
F30	Analog Output [FM] (Voltage adjustment)
F31	Analog Output [FM] (Function)
F33	Analog Output [FM] (Pulse rate)

These function codes allow terminal [FM] to output monitored data such as the output frequency and the output current in an analog DC voltage or pulse (pulse duty: approximately 50%). The magnitude of such analog voltage or pulse rate is adjustable.

■ Mode selection (F29)

F29 specifies the property of the output to terminal [FM]. You need to set switch SW6 on the interface printed circuit board (PCB). Refer to the FRENIC-Multi Instruction Manual, Chapter 2 "Mounting and Wiring of the Inverter."

Data for F29	Output form	Position of slide switch SW6 mounted on the interface PCB
0	Voltage (0 to +10 VDC) (<i>FMA</i> function)	FMA
2	Pulse (0 to 6000 p/s) (<i>FMP</i> function)	FMP

■ Voltage adjustment (F30) dedicated to *FMA*

F30 allows you to adjust the output voltage or current representing the monitored data selected by F31 within the range of 0 to 300%.

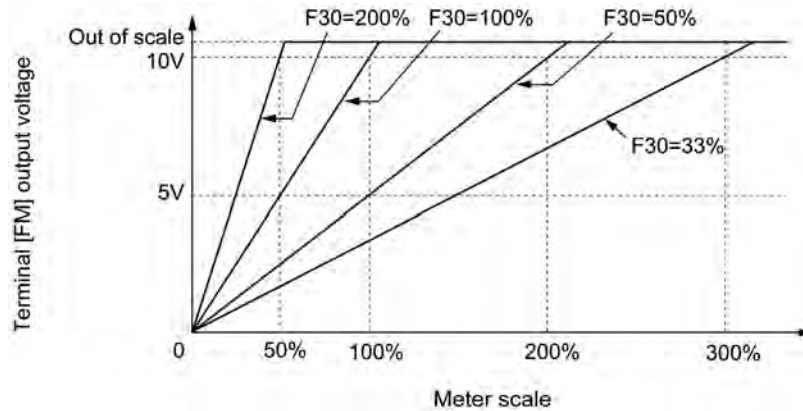

■ Function (F31)

F31 specifies what is output to analog output terminal [FM].

Data for F31	[FM] output	Function (Monitor the following)	Meter scale (Full scale at 100%)
0	Output frequency (before slip compensation)	Output frequency of the inverter (Equivalent to the motor synchronous speed)	Maximum frequency (F03/A01)
1	Output frequency (after slip compensation)	Output frequency of the inverter	Maximum frequency (F03/A01)
2	Output current	Output current (RMS) of the inverter	Twice the inverter rated current
3	Output voltage	Output voltage (RMS) of the inverter	250 V for 230 V, 500 V for 460 V
4	Output torque	Motor shaft torque	Twice the rated motor torque
5	Load factor	Load factor (Equivalent to the indication of the load meter)	Twice the rated motor load
6	Input power	Input power of the inverter	Twice the rated output of the inverter
7	PID feedback amount (PV)	Feedback amount under PID control	100% of the feedback amount
8	PG feedback value	Feedback value of closed loop control through the PG interface	Maximum speed (100% of the feedback value)
9	DC link bus voltage	DC link bus voltage of the inverter	500 V for 230 V, 1000 V for 460 V
10	Universal AO	Command via communications link (Refer to the RS-485 Communication User's Manual.)	20000 as 100%
13	Motor output	Motor output (kW)	Twice the rated motor output
14	Calibration	Full scale output of the meter calibration	This always outputs the full-scale (100%).
15	PID command (SV)	Command value under PID control	100% of the feedback amount
16	PID output (MV)	Output level of the PID controller under PID control (Frequency command)	Maximum frequency (F03/A01)



If F31 = 16 (PID output), J01 = 3 (Dancer control), and J62 = 2 or 3 (Ratio compensation enabled), the PID output is equivalent to the ratio against the primary reference frequency and may vary within $\pm 300\%$ of the frequency. The monitor displays the PID output in a converted absolute value. To indicate the value up to the full-scale of 300%, set F30 data to "33" (%).

■ Pulse rate (F33) dedicated to **FMP**

F33 specifies the number of pulses at which the output of the monitored item selected reaches 100%, in accordance with the specifications of the counter to be connected.

F37	Load Selection/Auto Torque Boost/Auto Energy Saving Operation 1 F09 (Torque Boost 1) A13 (Load Selection/Auto Torque Boost/Auto Energy Saving Operation 2)
------------	---

Refer to the descriptions of function code F09.

F39	Stop Frequency (Holding time) F25 (Stop Frequency)
------------	---

Refer to the description of function code F25.

F40	Torque Limiter 1 (Limiting level for driving) E16 (Torque Limiter 2, Limiting level for driving)
------------	---

F41	Torque Limiter 1 (Limiting level for braking) E17 (Torque Limiter 2, Limiting level for braking)
------------	---

If the inverter's output torque exceeds the specified levels of the driving torque limiter (F40/E16) and the braking torque limiter (F41/E17), the inverter controls the output frequency and limits the output torque for preventing a stall.

Specify the limiting levels at which the torque limiter becomes activated, as the percentage of the motor rated torque.

 To switch the inverter's output torque limiter between torque limiter 1 (F40/F41) and torque limiter 2 (E16/E17), use the terminal command **TL2/TL1** assigned to a digital input terminal. (Refer to the descriptions of E01 to E05.)

 The torque limiter and current limiter are very similar function each other. If both are activated concurrently, they may conflict each other and cause a hunting in the system. Avoid concurrent activation of these limiters.

F42	Control Mode Selection 1 H68 (Slip Compensation 1, Operating conditions) A14 (Control Mode Selection 2)
------------	---

F42 specifies the control mode of the inverter to control a motor.

Data for F42	Control mode
0	V/f control with slip compensation active
1	Dynamic torque vector control
2	V/f control with slip compensation active
3	V/f control with optional PG interface
4	Dynamic torque vector control with optional PG interface

■ V/f control

In this control, the inverter controls a motor by the voltage and frequency according to the V/f pattern specified by function codes.

■ Slip compensation

Applying any load to an induction motor causes a rotational slip due to the motor characteristics, decreasing the motor rotation. The inverter's slip compensation facility first presumes the slip value of the motor based on the motor torque generated and raises the output frequency to compensate for the decrease in motor rotation. This prevents the motor from decreasing the rotation due to the slip.

That is, this facility is effective for improving the motor speed control accuracy.

The compensation value is specified by combination of function codes P12 (Rated slip frequency), P09 (Slip compensation gain for driving) and P11 (Slip compensation gain for braking).

H68 enables or disables the slip compensation facility according to the motor driving conditions.

Data for H68	Motor driving conditions		Motor driving frequency zone	
	Accl/Decel	Constant speed	Base frequency or below	Above the base frequency
0	Enable	Enable	Enable	Enable
1	Disable	Enable	Enable	Enable
2	Enable	Enable	Enable	Disable
3	Disable	Enable	Enable	Disable

■ Dynamic torque vector control

To get the maximal torque out of a motor, this control calculates the motor torque for the load applied and uses it to optimize the voltage and current vector output.

Selecting this control automatically enables the auto torque boost and slip compensation function and disables auto energy saving operation. Using the PG feedback speed control at same time, however, also disables the slip compensation function.

This control is effective for improving the system response against external disturbances and the motor speed control accuracy.

■ PG speed feedback control (PG interface)

This control is made available by mounting an optional pulse generator (PG) interface card.

It uses the speed feedback from the PG on the motor shaft to control the motor speed with high accuracy.



In the slip compensation and dynamic torque vector control, the inverter uses the motor parameters to control its speed. Therefore, the following conditions should be satisfied; if not, the inverter may not get the proper performance from the motor.

- A single motor should be controlled. (It is difficult to apply this control to a group motor driving system.)
- Motor parameters P02, P03 and P06 to P12 are properly configured or they are fully auto-tuned.
- The rating of the motor to be controlled should be two ranks lower than that of the inverter. If not, the output current detection sensibility of the motor lowers, causing it difficult to accurately control the motor.
- The wiring between the inverter output and motor input terminals should not exceed 164 ft (50 m) in length. A long wiring run could not suppress the earth leakage current since the cable's electrostatic capacitance against the earth increases, causing it difficult to accurately control the motor speed.

F43	Current Limiter (Mode selection)
F44	Current Limiter (Level)

When the output current of the inverter exceeds the level specified by the current limiter (F44), the inverter automatically manages its output frequency to prevent a stall and limit the output current. (Refer to the description of function code H12.)

If F43 = 1, the current limiter is enabled only during constant speed operation. If F43 = 2, the current limiter is enabled during both of acceleration and constant speed operation. Choose F43 = 1 if you need to run the inverter at full capability during acceleration and to limit the output current during constant speed operation.

■ Mode selection (F43)

F43 selects the motor running state in which the current limiter will be active.

Data for F43	Running states that enable the current limiter		
	During acceleration	During constant speed	During deceleration
0	Disable	Disable	Disable
1	Disable	Enable	Disable
2	Enable	Enable	Disable

■ Level (F44)

F44 specifies the operation level at which the output current limiter becomes activated, in ratio to the inverter rating.



- Since the current limit operation with F43 and F44 is performed by software, it may cause a delay in control. If you need a quick response, specify a current limit operation by hardware (H12 = 1) at the same time.
- If an excessive load is applied when the current limiter operation level is set extremely low, the inverter will rapidly lower its output frequency. This may cause an overvoltage trip or dangerous turnover of the motor rotation due to undershooting.
- The torque limiter and current limiter are very similar function each other. If both are activated concurrently, they may conflict each other and cause a hunting in the system. Avoid concurrent activation of these limiters.

F50	Electronic Thermal Overload Protection for Braking Resistor (Discharging capability)
F51	Electronic Thermal Overload Protection for Braking Resistor (Allowable average loss)

These function codes specify the electronic thermal overload protection feature for the braking resistor.

Set F50 and F51 data to the discharging capability and allowable average loss, respectively. Those values differ depending on the specifications of the braking resistor, as listed on the following pages.



Depending on the thermal marginal characteristics of the braking resistor, the electronic thermal overload protection feature may act so that the inverter issues the overheat protection alarm *OLH* even if the actual temperature rise is not enough. If it happens, review the relationship between the performance index of the braking resistor and settings of related function codes.

The table below lists the discharging capability and allowable average loss of the braking resistor. These values depend upon the inverter and braking resistor models.

■ External Braking Resistors

Standard models

The thermal sensor relay mounted on the braking resistor acts as a thermal protector of the motor for overheat, so assign an "Enable external alarm trip" terminal command **THR** to any of digital input terminals [X1] to [X5], [FWD] and [REV] and connect that terminal and its common terminal to braking resistor's terminals 2 and 1.

To protect the motor from overheat without using the thermal sensor relay mounted on the braking resistor, configure the electronic thermal overload protection facility by setting F50 and F51 data to the discharging capability and allowable average loss values listed below, respectively.

Power supply voltage	Inverter type	Braking resistor		Resistance (Ω)	Continuous braking (100% braking torque)		Intermittent braking (Period: Less than 100s)	
		Type	Qty.		Discharging capability (kW)	Braking time (s)	Allowable average loss (kW)	Duty (%ED)
Three-phase 230 V	FRNF12E1S-2U	DB0.75-2	1	100	9	90	0.037	37
	FRNF25E1S-2U							
	FRNF50E1S-2U				45	0.044	22	
	FRN001E1S-2U							
	FRN002E1S-2U	DB2.2-2		40	34	30	0.077	7
	FRN003E1S-2U							
	FRN005E1S-2U	DB3.7-2		33	37	20	0.093	5
	FRN007E1S-2U	DB5.5-2		20	55	10	0.138	
	FRN010E1S-2U	DB7.5-2		15	37		0.188	
	FRN015E1S-2U	DB11-2		10	55	0.275		
FRN020E1S-2U	DB15-2	8.6	75	0.375				
Three-phase 460 V	FRNF50E1S-4U	DB0.75-4	1	200	9	45	0.044	22
	FRN001E1S-4U							
	FRN002E1S-4U	DB2.2-4		160	34	30	0.077	7
	FRN003E1S-4U							
	FRN005E1S-4U	DB3.7-4		130	37	20	0.093	5
	FRN007E1S-4U	DB5.5-4		80	55	10	0.138	
	FRN010E1S-4U	DB7.5-4		60	38		0.188	
	FRN015E1S-4U	DB11-4		40	55	0.275		
	FRN020E1S-4U	DB15-4		34.4	75	0.375		
Single-phase 230 V	FRNF12E1S-7U	DB0.75-2	1	100	9	90	0.037	37
	FRNF25E1S-7U							
	FRNF50E1S-7U				45	0.044	22	
	FRN001E1S-7U							
	FRN002E1S-7U	DB2.2-2		40	34	30	0.077	7
FRN003E1S-7U								

10% ED models

Power supply voltage	Inverter type	Braking resistor		Resistance (Ω)	Continuous braking (100% braking torque)		Intermittent braking (Period: Less than 100s)	
		Type	Qty.		Discharging capacity (kW)	Braking time (s)	Allowable average loss (kW)	Duty (%ED)
Three-phase 230 V	FRNF12E1S-2U	DB0.75-2C	1	100	50	1000	0.075	100
	FRNF25E1S-2U					500		75
	FRNF50E1S-2U					250		37
	FRN001E1S-2U					133		20
	FRN002E1S-2U	DB2.2-2C		40	55	73	0.110	14
	FRN003E1S-2U			50		10		
	FRN005E1S-2U	DB3.7-2C		33	140		75	0.185
	FRN007E1S-2U	DB5.5-2C		20	55		20	0.275
	FRN010E1S-2U	DB7.5-2C		15	37		10	0.375
	FRN015E1S-2U	DB11-2C		10	55			0.55
FRN020E1S-2U	DB15-2C	8.6	75	0.75				
Three-phase 460 V	FRNF50E1S-4U	DB0.75-4C	1	200	50	250	0.075	37
	FRN001E1S-4U					133		20
	FRN002E1S-4U	DB2.2-4C		160	55	73	0.110	14
	FRN003E1S-4U			50		10		
	FRN005E1S-4U	DB3.7-4C		130	140		75	0.185
	FRN007E1S-4U	DB5.5-4C		80	55		20	0.275
	FRN010E1S-4U	DB7.5-4C		60	38		10	0.375
	FRN015E1S-4U	DB11-4C		40	55			0.55
	FRN020E1S-4U	DB15-4C		34.4	75		0.75	
Single-phase 230 V	FRNF12E1S-7U	DB0.75-2C	1	100	50	1000	0.075	100
	FRNF25E1S-7U					500		75
	FRNF50E1S-7U					250		37
	FRN001E1S-7U					133		20
	FRN002E1S-7U	DB2.2-2C		40	55	73	0.110	14
	FRN003E1S-7U			50		10		

Calculating the discharging capability and allowable average loss of the braking resistor and configuring the function code data

When using a braking resistor other than the ones listed in the above table, calculate data to be set to function codes according to the tables and expressions.

■ Discharging capability (F50)

The discharging capability refers to kW's allowable for a single braking cycle, which is obtained by the following expressions "(1) Regeneration power during deceleration" and "(2) Regeneration power at a constant speed," based on the braking time and motor rating.

Data for F50	Function
0	Reserved.
1 to 900	1 to 900 (kW's)
999	Disable the electronic thermal overload protection facility

During deceleration:

$$\text{Discharging capacity (kW's)} = \frac{\text{Braking time (s)} \times \text{Motor rating (kW)}}{2} \quad (1)$$

At a constant speed:

$$\text{Discharging capacity (kW's)} = \text{Braking time (s)} \times \text{Motor rating (kW)} \quad (2)$$

■ Allowable average loss (F51)

The allowable average loss refers to resistance allowable for motor continuous operation, which is obtained by the following expressions "(3) Regeneration power during deceleration" and "(4) Regeneration power at a constant speed," based on the %ED (%) and motor rating (kW).

Data for F51	Function
0.000	Reserved.
0.001 to 50.000	0.001 to 50.000 (kW)

During deceleration:

$$\text{Allowable average loss (kW)} = \frac{\frac{\%ED (\%)}{100} \times \text{Motor rating (kW)}}{2} \quad (3)$$

At a constant speed:

$$\text{Allowable average loss (kW)} = \frac{\%ED (\%)}{100} \times \text{Motor rating (kW)} \quad (4)$$

When the motor decelerates, apply expressions (1) and (3), and when it runs at a constant speed, expressions (2) and (4). The obtained data differs depending upon the motor's running state.

9.2.2 E codes (Extension terminal functions)

E01	Terminal [X1] Function	E98 (Terminal [FWD] Function)
E02	Terminal [X2] Function	E99 (Terminal [REV] Function)
E03	Terminal [X3] Function	
E04	Terminal [X4] Function	
E05	Terminal [X5] Function	

Function codes E01 to E05, E98 and E99 allow you to assign commands to terminals [X1] to [X5], [FWD], and [REV] which are general-purpose, programmable, digital input terminals.

These function codes may also switch the logic system between normal and negative to define how the inverter logic interprets either ON or OFF status of each terminal. The default setting is normal logic system "Active ON." So, explanations that follow are given in normal logic system "Active ON."

CAUTION

In the case of digital input, you can assign commands to the switching means for the run command and its operation and the reference frequency (e.g., *SS1*, *SS2*, *SS4*, *SS8*, *Hz2/Hz1*, *Hz/PID*, *IVS*, and *LE*). Be aware that switching any of such signals may cause a sudden start (running) or an abrupt change in speed.

An accident or physical injury may result.

Function code data		Terminal commands assigned	Symbol
Active ON	Active OFF		
0	1000	Select multi-frequency (0 to 15 steps)	SS1
1	1001		SS2
2	1002		SS4
3	1003		SS8
4	1004	Select ACC/DEC time	RT1
6	1006	Enable 3-wire operation	HLD
7	1007	Coast to a stop	BX
8	1008	Reset alarm	RST
9	1009	Enable external alarm trip	THR
10	1010	Ready for jogging	JOG
11	1011	Select frequency command 2/1	Hz2/Hz1
12	1012	Select motor 2 / motor 1	M2/M1
13	—	Enable DC braking	DCBRK
14	1014	Select torque limiter level	TL2/TL1
17	1017	UP (Increase output frequency)	UP
18	1018	DOWN (Decrease output frequency)	DOWN
19	1019	Enable data change with keypad	WE-KP
20	1020	Cancel PID control	Hz/PID
21	1021	Switch normal/inverse operation	IVS
24	1024	Enable communications link via RS-485 or field bus	LE
25	1025	Universal DI	U-DI
26	1026	Enable auto search for idling motor speed at starting	STM
30	1030	Force to stop	STOP
33	1033	Reset PID integral and differential components	PID-RST
34	1034	Hold PID integral component	PID-HLD
42	1042	Reserved	
43	1043		
44	1044		
45	1045		
98	—	Run forward (Exclusively assigned to [FWD] and [REV] terminals by E98 and E99)	FWD
99	—	Run reverse (Exclusively assigned to [FWD] and [REV] terminals by E98 and E99)	REV



Any negative logic (Active OFF) command cannot be assigned to the functions marked with "—" in the "Active OFF" column.

The "Enable external alarm trip" and "Force to stop" are fail-safe terminal commands. For example, when data = 9 in "Enable external alarm trip," "Active OFF" (alarm is triggered when OFF); when data = 1009, "Active ON" (alarm is triggered when ON).

Terminal function assignment and data setting

- Select multi-frequency (0 to 15 steps) -- **SS1**, **SS2**, **SS4**, and **SS8**
(Function code data = 0, 1, 2, and 3)

The combination of the ON/OFF states of digital input signals **SS1**, **SS2**, **SS4** and **SS8** selects one of 16 different frequency commands defined beforehand by 15 function codes C05 to C19 (Multi-frequency 0 to 15). With this, the inverter can drive the motor at 16 different preset frequencies.

The table below lists the frequencies that can be obtained by the combination of switching **SS1**, **SS2**, **SS4** and **SS8**. In the "Selected frequency" column, "Other than multi-frequency" represents the reference frequency sourced by frequency command 1 (F01), frequency command 2 (C30), or others. For details, refer to the block diagram in Section 4.2 "Drive Frequency Command Block."

SS8	SS4	SS2	SS1	Selected frequency
OFF	OFF	OFF	OFF	Other than multi-frequency
OFF	OFF	OFF	ON	C05 (Multi-frequency 1)
OFF	OFF	ON	OFF	C06 (Multi-frequency 2)
OFF	OFF	ON	ON	C07 (Multi-frequency 3)
OFF	ON	OFF	OFF	C08 (Multi-frequency 4)
OFF	ON	OFF	ON	C09 (Multi-frequency 5)
OFF	ON	ON	OFF	C10 (Multi-frequency 6)
OFF	ON	ON	ON	C11 (Multi-frequency 7)
ON	OFF	OFF	OFF	C12 (Multi-frequency 8)
ON	OFF	OFF	ON	C13 (Multi-frequency 9)
ON	OFF	ON	OFF	C14 (Multi-frequency 10)
ON	OFF	ON	ON	C15 (Multi-frequency 11)
ON	ON	OFF	OFF	C16 (Multi-frequency 12)
ON	ON	OFF	ON	C17 (Multi-frequency 13)
ON	ON	ON	OFF	C18 (Multi-frequency 14)
ON	ON	ON	ON	C19 (Multi-frequency 15)

- Select ACC/DEC time -- **RT1**
(Function code data = 4)

This terminal command switches between ACC/DEC time 1 (F07/F08) and ACC/DEC time 2 (E10/E11).

If no **RT1** command is assigned, ACC/DEC time 1 (F07/F08) takes effect by default.

Input terminal command RT1	Acceleration/deceleration time
OFF	Acceleration/deceleration time 1 (F07/F08)
ON	Acceleration/deceleration time 2 (E10/E11)

- Enable 3-wire operation -- **HLD**
(Function code data = 6)

Turning this terminal command ON self-holds the forward **FWD** or reverse **REV** run command issued with it, to enable 3-wire inverter operation.

Turning **HLD** ON self-holds the first **FWD** or **REV** command at its leading edge. Turning **HLD** OFF releases the self-holding.

When **HLD** is not assigned, 2-wire operation involving only **FWD** and **REV** takes effect.

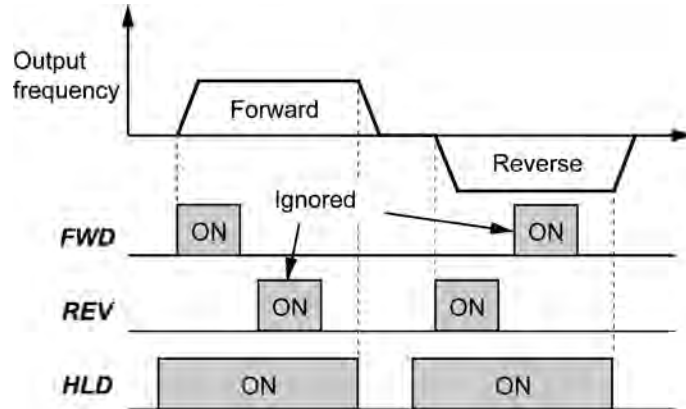

- Coast to a stop -- **BX**
(Function code data = 7)

Turning this terminal command ON immediately shuts down the inverter output so that the motor coasts to a stop without issuing any alarms.

- Reset alarm -- **RST**
(Function code data = 8)

Turning this terminal command ON clears the **ALM** state--alarm output (for any fault). Turning it OFF erases the alarm display and clears the alarm hold state.

When you turn the **RST** command ON, keep it ON for 10 ms or more. This command should be kept OFF for the normal inverter operation.

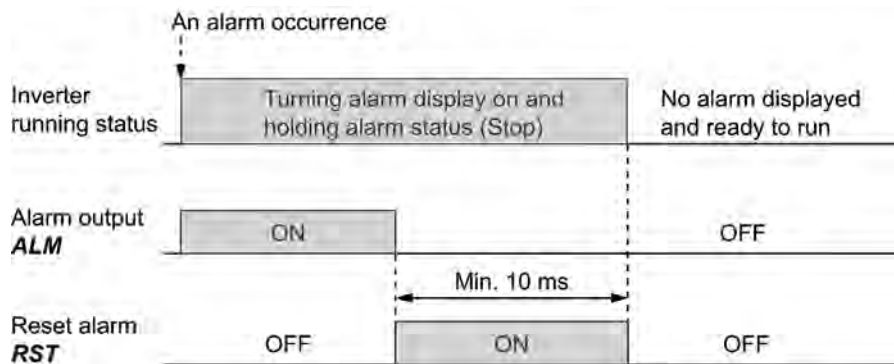

- Enable external alarm trip -- **THR**
(Function code data = 9)



Turning this terminal command OFF immediately shuts down the inverter output (so that the motor coasts to a stop), displays the alarm $\overline{O/H}$, and outputs the alarm relay (for any fault) **ALM**. The **THR** command is self-held, and is reset when an alarm reset takes place.

 Use this alarm trip command from external equipment when you have to immediately shut down the inverter output in the event of an abnormal situation in a peripheral equipment.



- Ready for jogging -- **JOG**
(Function code data = 10)

This terminal command is used to jog or inch the motor for positioning a work piece.



Turning this command ON makes the inverter ready for jogging.

Simultaneous keying  +  keys on the keypad is functionally equivalent to this command; however, it is restricted by the run command source as listed below.

When the run command source is the keypad (F02 = 0, 2 or 3):



Input terminal command JOG	 +  keys on the keypad	Inverter running state
ON	—	Ready for jogging
OFF	Pressing these keys toggles between the "normal operation" and "ready for jogging."	Normal operation
		Ready for jogging

When the run command source is digital input (F02 = 1):

Input terminal command JOG	 +  keys on the keypad	Inverter running state
ON	Disable	Ready for jogging
OFF		Normal operation

Jogging operation

Pressing the  key or turning the **FWD** or **REV** terminal command ON starts jogging.

For the jogging by the keypad, the inverter jogs only when the  key is held down. Releasing the  key decelerates to stop.

During jogging, the frequency specified by C20 (Jogging Frequency) and the acceleration/deceleration time specified by H54 (ACC/DEC Time) apply.

-  **Note**
- The inverter's status transition between "ready for jogging" and "normal operation" is possible only when the inverter is stopped.
 - To start jogging operation with the **JOG** terminal command and a run command (e.g., **FWD**), the input of the **JOG** should not be delayed 100 ms or more from that of the run command. If the delay exceeds 100 ms, the inverter does not jog the motor but runs it ordinarily until the next input of the **JOG**.

- Select frequency command 2/1 -- **H_z2/H_z1**
(Function code data = 11)

Turning this terminal command ON and OFF switches the frequency command source between frequency command 1 (F01) and frequency command 2 (C30).

If no **H_z2/H_z1** terminal command is assigned, the frequency sourced by F01 takes effect by default.

Input terminal command H_z2/H_z1	Frequency command source
OFF	Follow F01 (Frequency command 1)
ON	Follow C30 (Frequency command 2)

- Select motor 2 / motor 1 -- **M2/M1**
(Function code data = 12)

Turning this terminal command ON switches from motor 1 to motor 2. Switching is possible only when the inverter is stopped. Upon completion of switching, the digital terminal output "Switched to motor 2" **SWM2** (assigned to any of terminals [Y1], [Y2] and [30A/B/C]) turns ON.

If no **M2/M1** terminal command is assigned, motor 1 is selected by default.

Input terminal command M2/M1	Selected motor	SWM2 status after completion of switching
OFF	Motor 1	OFF
ON	Motor 2	ON

Switching between motors 1 and 2 automatically switches applicable function codes as listed below. The inverter runs the motor with those codes that should be properly configured.

Function code name		For Motor 1	For Motor 2
Maximum Frequency		F03	A01
Base Frequency		F04	A02
Rated voltage at Base Frequency		F05	A03
Maximum Output Voltage		F06	A04
Torque Boost		F09	A05
Electronic Thermal Overload Protection for Motor (Select motor characteristics) (Overload detection level) (Thermal time constant)		F10	A06
		F11	A07
		F12	A08
DC Braking (Braking starting frequency) (Braking level) (Braking time)		F20	A09
		F21	A10
		F22	A11
Starting Frequency		F23	A12
Load Selection/Auto Torque Boost/Auto Energy Saving Operation		F37	A13
Control Mode Selection		F42	A14
Motor	(No. of poles)	P01	A15
	(Rated capacity)	P02	A16
	(Rated current)	P03	A17
	(Auto-tuning)	P04	A18
	(Online tuning)	P05	A19
	(No-load current)	P06	A20
	(%R1)	P07	A21
	(%X)	P08	A22
	(Slip compensation gain for driving)	P09	A23
	(Slip compensation response time)	P10	A24
	(Slip compensation gain for braking)	P11	A25
	(Rated slip frequency)	P12	A26
Motor Selection		P99	A39
Slip Compensation	(Operating conditions)	H68	A40
Output Current Fluctuation Damping Gain for Motor		H80	A41
Cumulative Motor Run Time		H94	A45
Startup Times of Motor		H44	A46

Motor 2 imposes functional restrictions on the following function codes. Confirm the settings of those function codes before use.

Functions	Restrictions	Related function codes
Non-linear V/f pattern	Disabled. Linear V/f pattern only	H50 to H53
Starting frequency	Starting frequency holding time not supported.	F24
Stop frequency	Stop frequency holding time not supported.	F39
Overload early warning	Disabled.	E34 and E35
Droop control	Disabled.	H28
<i>UP/DOWN</i> control	Disabled. Fixed at default setting 0.	H61
PID control	Disabled.	J01
Braking signal	Disabled.	J68 to J72
Software current limiter	Disabled.	F43 and F44
Rotation direction limitation	Disabled.	H08
Overload stop	Disabled.	J63 to J67

 To run motor 2 with the *M2/M1* terminal command and a run command (e.g., *FWD*), the input of the *M2/M1* should not be delayed 10 ms or more from that of the run command. If the delay exceeds 10 ms, motor 1 will be driven by default.

- Enable DC braking -- *DCBRK*
(Function code data = 13)

This terminal command gives the inverter a DC braking command through the inverter's digital input.

(Refer to the descriptions of F20 to F22 for DC braking.)

- Select torque limiter level -- *TL2/TL1*
(Function code data = 14)

This terminal command switches between torque limiter 1 (F40 and F41) and torque limiter 2 (E16 and E17) as listed below.

If no *TL2/TL1* terminal command is assigned, torque limiter 1 (F40 and F41) takes effect by default.

Input terminal command <i>TL2/TL1</i>	Torque limiter level
OFF	Torque limiter 1 (F40 and F41)
ON	Torque limiter 2 (E16 and E17)

- UP (Increase output frequency) and DOWN (Decrease output frequency) commands -- **UP** and **DOWN**
(Function code data = 17, 18)

- **Frequency setting**

When the **UP/DOWN** control is selected for frequency setting with a run command ON, turning the **UP** or **DOWN** terminal command ON causes the output frequency to increase or decrease, respectively, within the range from 0 Hz to the maximum frequency as listed below.

UP	DOWN	Function
Data = 17	Data = 18	
OFF	OFF	Keep the current output frequency.
ON	OFF	Increase the output frequency with the acceleration time currently specified.
OFF	ON	Decrease the output frequency with the deceleration time currently specified.
ON	ON	Keep the current output frequency.

The **UP/DOWN** control is available in two modes--one mode (H61 = 0) in which the initial value of the reference frequency is fixed to "0.00" at the start of the **UP/DOWN** control and the other mode (H61 = 1) in which the reference frequency applied in the previous **UP/DOWN** control applies as the initial value.

When H61 = 0, the reference frequency applied by the previous **UP/DOWN** control has been cleared to "0," so at the next restart (including powering on), use the **UP** terminal command to accelerate the speed as needed.

When H61 = 1, the inverter internally holds the current output frequency set by the **UP/DOWN** control and applies the held frequency at the next restart (including powering on).

Note At the time of restart, if an **UP** or **DOWN** terminal command is entered before the internal frequency reaches the output frequency saved in the memory, the inverter saves the current output frequency into the memory and starts the **UP/DOWN** control with the new frequency. The previous frequency held will be overwritten by the current one.

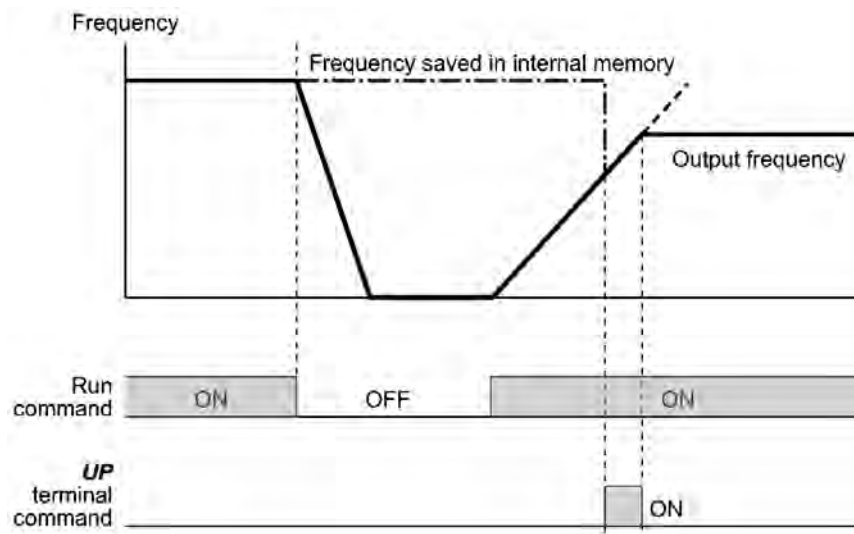

Initial frequency for the **UP/DOWN** control when the frequency command source is switched
 When the frequency command source is switched to the **UP/DOWN** control from other sources, the initial frequency for the **UP/DOWN** control is as listed below:

Frequency command source	Switching command	Initial frequency for UP/DOWN control	
		H61 = 0	H61 = 1
Other than UP/DOWN (F01, C30)	Select frequency command 2/1 (Hz2/Hz1)	Reference frequency given by the frequency command source used just before switching	
PID conditioner	Cancel PID control (Hz/PID)	Reference frequency given by PID control (PID controller output)	
Multi-frequency	Select multi-frequency (SS1, SS2, SS4 and SS8)	Reference frequency given by the frequency command source used just before switching	Reference frequency at the time of previous UP/DOWN control
Communications link	Enable communications link via RS-485 or field bus (LE)		

 To enable the **UP** and **DOWN** terminal commands, you need to set frequency command 1 (F01) or frequency command 2 (C30) to "7" beforehand.

• **Changing the PID speed command value**

When the **UP/DOWN** control is selected as a PID speed command, turning the **UP** or **DOWN** terminal command ON with a run command being ON causes the PID speed command to change within the range from 0 to 100%.

The PID speed command can be specified in mnemonic physical quantities (such as temperature or pressure) with the PID display coefficients (E40, E41).

UP	DOWN	Function
Data = 17	Data = 18	
OFF	OFF	Retain PID speed command value.
ON	OFF	Increase PID speed command value at a rate between 0.1%/0.1 s and 1%/0.1 s.
OFF	ON	Decrease PID speed command value at a rate between 0.1%/0.1 s and 1%/0.1 s.
ON	ON	Retain PID speed command value.

Selecting the PID control for process control (J01 = 1 or 2) validates the H61 data as well as frequency commands. Selecting it for dancer control (J01 = 3) runs the motor with H61 = 1 regardless of the actual H61 data; that is, the inverter internally holds the current PID command specified by the **UP/DOWN** control and applies the held PID command at the next restart (including powering on).

 To validate **UP** and **DOWN** terminal commands, it is necessary to select the PID control (Remote command **SV**) (J02 = 3).

- Enable data change with keypad -- **WE-KP**
(Function code data = 19)

Turning this terminal command OFF protects function code data from unintentionally getting changed with the keypad.

Only when the **WE-KP** terminal command is ON, you can change function code data with the keypad according to the setting of function code F00 as listed below.

WE-KP	F00	Function
OFF	--	Disable changing of all function code data
ON	0 or 2	Enable changing of all function code data
	1 or 3	Disable changing of all function code data except F00 data

If no **WE-KP** terminal command is assigned, the inverter interprets **WE-KP** as being ON by default.



- If you mistakenly assign a **WE-KP** terminal command, you no longer edit or modify function code data. In such a case, temporarily turn this **WE-KP**-assigned terminal ON and reassign the **WE-KP** terminal command to a correct command.
- **WE-KP** is only a signal that allows you to change function code data, so it does not protect the frequency settings or PID speed command specified by the \wedge and \vee keys.

- Cancel PID control -- **Hz/PID**
(Function code data = 20)

Turning this terminal command ON disables the PID control.

If the PID control is disabled with this command, the inverter runs the motor with the reference frequency manually set by any of the multi-frequency, keypad, analog input, etc.

Hz/PID	Function
OFF	Enable PID control
ON	Disable PID control/Enable manual settings

- Switch normal/inverse operation -- **IVS**
(Function code data = 21)

This terminal command switches the output frequency control between normal (proportional to the input value) and inverse in PID process control and manual frequency command. To select the inverse operation, turn the **IVS** ON.

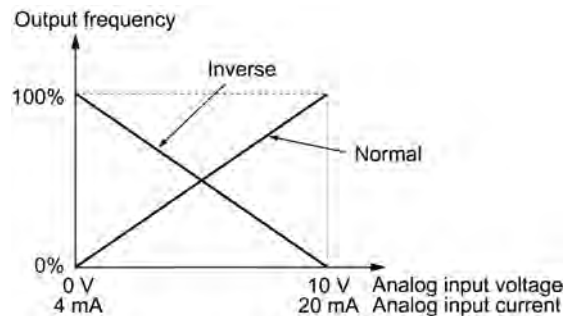

The normal/inverse switching operation is useful for air-conditioners that require switching between cooling and heating. In cooling, the speed of the fan motor (output frequency of the inverter) is increased to lower the temperature. In heating, it is reduced to lower the temperature. This switching is realized by this **IVS** terminal command.

- **When the inverter is driven by an external analog frequency command sources (terminals [12] and [C1]):**

Switching normal/inverse operation can apply only to the analog frequency command sources (terminals [12] and [C1]) in frequency command 1 (F01) and does not affect frequency command 2 (C30) or *UP/DOWN* control.

As listed below, the combination of the "Selection of normal/inverse operation for frequency command 1" (C53) and the *IVS* terminal command determines the final operation.

Combination of C53 and *IVS*

Data for C53	<i>IVS</i>	Final operation
0: Normal operation	OFF	Normal
	ON	Inverse
1: Inverse operation	OFF	Inverse
	ON	Normal

- **When the process control is performed by the PID control facility integrated in the inverter:**

The "Cancel PID control" terminal command *H_z/PID* can switch the PID control between enabled (process is to be controlled by the PID controller) and disabled (process is to be controlled by the manual frequency setting). In either case, the combination of the "PID control" (J01) or "Selection of normal/inverse operation for frequency command 1" (C53) and the *IVS* command determines the final operation as listed below.

When the PID control is enabled:

The normal/inverse operation selection for the PID controller output (reference frequency) is as follows.

PID control (Mode selection) (J01)	<i>IVS</i>	Final operation
1: Enable (normal operation)	OFF	Normal
	ON	Inverse
2: Enable (inverse operation)	OFF	Inverse
	ON	Normal

When the PID control is disabled:

The normal/inverse operation selection for the manual reference frequency is as follows.

Selection of normal/inverse operation for frequency command 1 (C53)	<i>IVS</i>	Final operation
0: Normal operation	–	Normal
1: Inverse operation	–	Inverse



When the process control is performed by the PID control facility integrated in the inverter, the *IVS* terminal command is used to switch the PID controller output (reference frequency) between normal and inverse, and has no effect on any normal/inverse operation selection of the manual frequency setting.

-
- Enable communications link via RS-485 or field bus (option) -- **LE**
(Function code data = 24)

Turning this terminal command ON assigns priorities to frequency commands or run commands received via the RS-485 communications link (H30) or the field bus option (y98).

No **LE** assignment is functionally equivalent to the **LE** being ON. (Refer to H30 (Communications link function) and y98 (Bus link function).)

- Universal DI -- **U-DI**
(Function code data = 25)

Using **U-DI** enables the inverter to monitor digital signals sent from the peripheral equipment via an RS-485 communications link or a field bus option by feeding those signals to the digital input terminals. Signals assigned to the universal DI are simply monitored and do not operate the inverter.

 For an access to universal DI via the RS-485 or field bus communications link, refer to their respective Instruction Manuals.

- Enable auto search for idling motor speed at starting -- **STM**
(Function code data = 26)

This digital terminal command determines, at the start of operation, whether or not to search for idling motor speed and follow it. Refer to H09 (Starting mode).

- Force to stop -- **STOP**
(Function code data = 30)

Turning this terminal command OFF causes the motor to decelerate to a stop in accordance with the H56 data (Deceleration time for forced stop). After the motor stops, the inverter enters the alarm state with the alarm $\overline{E}r\overline{E}$ displayed.

- Reset PID integral and differential components -- **PID-RST**
(Function code data = 33)

Turning this terminal command ON resets the integral and differential components of the PID processor.

- Hold PID integral component -- **PID-HLD**
(Function code data = 34)

Turning this terminal command ON holds the integral components of the PID processor.

- Run forward -- **FWD**
(Function code data = 98)

Turning this terminal command ON runs the motor in the forward direction; turning it OFF decelerates it to stop.

 This terminal command can be assigned only by E98 or E99.

- Run reverse -- **REV**
(Function code data = 99)

Turning this terminal command ON runs the motor in the reverse direction; turning it OFF decelerates it to stop.

 This terminal command can be assigned only by E98 or E99.

E10	Acceleration Time 2	F07 (Acceleration Time 1)
E11	Deceleration Time 2	F08 (Deceleration Time 1)

Refer to the descriptions of function codes F07 and F08.

E16	Torque Limiter 2 (Limiting level for driving) F40 (Torque Limiter 1, Limiting level for driving)
E17	Torque Limiter 2 (Limiting level for braking) F41 (Torque Limiter 1, Limiting level for braking)

Refer to the descriptions of function codes F40 and F41.

E20	Terminal [Y1] Function
E21	Terminal [Y2] Function
E27	Terminal [30A/B/C] Function (Relay output)

E20, E21, and E27 assign output signals (listed on the next page) to general-purpose, programmable output terminals [Y1], [Y2], and [30A/B/C]. These function codes can also switch the logic system between normal and negative to define the property of those output terminals so that the inverter logic can interpret either the ON or OFF status of each terminal as active. The factory default settings are "Active ON."

Terminals [Y1] and [Y2] are transistor outputs and terminals [30A/B/C] are relay contact outputs. In normal logic, if an alarm occurs, the relay will be energized so that [30A] and [30C] will be closed, and [30B] and [30C] opened. In negative logic, the relay will be deenergized so that [30A] and [30C] will be opened, and [30B] and [30C] closed. This may be useful for the implementation of failsafe power systems.



- When a negative logic is employed, all output signals are active (e.g. an alarm would be recognized) while the inverter is powered OFF. To avoid causing system malfunctions by this, interlock these signals to keep them ON using an external power supply. Furthermore, the validity of these output signals is not guaranteed for approximately 1.5 seconds after power-on, so introduce such a mechanism that masks them during the transient period.
- Terminals [30A/B/C] use mechanical contacts that cannot stand frequent ON/OFF switching. Where frequent ON/OFF switching is anticipated (for example, limiting a current by using signals subjected to inverter output limit control such as switching to commercial power line), use transistor outputs [Y1] and [Y2] instead. The service life of a relay is approximately 200,000 times if it is switched on and off at one-second intervals.

The table below lists functions that can be assigned to terminals [Y1], [Y2], and [30A/B/C].
 To make the explanations simpler, the examples shown below are all written for the normal logic (Active ON.)

Function code data		Functions assigned	Symbol
Active ON	Active OFF		
0	1000	Inverter running	<i>RUN</i>
1	1001	Frequency arrival signal	<i>FAR</i>
2	1002	Frequency detected	<i>FDT</i>
3	1003	Undervoltage detected (Inverter stopped)	<i>LU</i>
4	1004	Torque polarity detected	<i>B/D</i>
5	1005	Inverter output limiting	<i>IOL</i>
6	1006	Auto-restarting after momentary power failure	<i>IPF</i>
7	1007	Motor overload early warning	<i>OL</i>
10	1010	Inverter ready to run	<i>RDY</i>
21	1021	Frequency arrival signal 2	<i>FAR2</i>
22	1022	Inverter output limiting with delay	<i>IOL2</i>
26	1026	Auto-resetting	<i>TRY</i>
28	1028	Heat sink overheat early warning	<i>OH</i>
30	1030	Service lifetime alarm	<i>LIFE</i>
33	1033	Reference loss detected	<i>REF OFF</i>
35	1035	Inverter output on	<i>RUN2</i>
36	1036	Overload prevention control	<i>OLP</i>
37	1037	Current detected	<i>ID</i>
38	1038	Current detected 2	<i>ID2</i>
42	1042	PID alarm	<i>PID-ALM</i>
49	1049	Switched to motor 2	<i>SWM2</i>
57	1057	Brake signal	<i>BRKS</i>
80	1080	Reserved (for particular manufacturers)	
81	1081		
82	1082		
99	1099	Alarm output (for any alarm)	<i>ALM</i>

■ Inverter running -- ***RUN***
(Function code data = 0)

This output signal tells the external equipment that the inverter is running at a starting frequency or higher. It comes ON when the output frequency exceeds the starting frequency, and it goes OFF when it is less than the stop frequency. It is also OFF when the DC braking is in operation.

If this signal is assigned in negative logic (Active OFF), it can be used as a signal indicating "Inverter being stopped."

■ Frequency arrival signal -- ***FAR***
(Function code data = 1)

This output signal comes ON when the difference between the output frequency and reference frequency comes within the frequency arrival hysteresis width specified by E30. (Refer to the descriptions of E29 and E30.)

■ Frequency detected -- ***FDT***
(Function code data = 2)

This output signal comes ON when the output frequency exceeds the frequency detection level specified by E31, and it goes OFF when the output frequency drops below the "Frequency detection level (E31) - Hysteresis width (E32)."

■ Undervoltage detected -- ***LU***
(Function code data = 3)

This output signal comes ON when the DC link bus voltage of the inverter drops below the specified undervoltage level, and it goes OFF when the voltage exceeds the level.

This signal is ON also when the undervoltage protective function is activated so that the motor is in an abnormal stop state (e.g., tripped).

When this signal is ON, a run command is disabled if given.

■ Torque polarity detected -- ***B/D***
(Function code data = 4)

The inverter detects the polarity of the internally calculated torque and issues the driving or braking polarity signal to this digital output. This signal comes OFF when the calculated torque is the driving one, and it goes ON when it is the braking one.

■ Inverter output limiting -- ***IOL***
(Function code data = 5)

This output signal comes ON when the inverter is limiting the output frequency by activating any of the following actions (minimum width of the output signal: 100 ms).

- Torque limiting (F40, F41, E16 and E17)
- Current limiting by software (F43 and F44)
- Instantaneous overcurrent limiting by hardware (H12 = 1)
- Automatic deceleration (Anti-regenerative control) (H69 = 2 or 4)
- Overload stop (Hit mechanical stop) (J65 = 3)



When the ***IOL*** signal is ON, it may mean that the output frequency may have deviated from the frequency specified by the frequency command because of this limiting function.

-
- Auto-restarting after momentary power failure -- **IPF**
(Function code data = 6)

This output signal is ON either during continuous running after a momentary power failure or during the period from when the inverter has detected an undervoltage condition and shut down the output until restart has been completed (the output has reached the reference frequency).

To enable this **IPF** signal, set F14 (Restart mode after momentary power failure) to "4: Enable restart (Restart at the frequency at which the power failure occurred)" or "5: Enable restart (Restart at the starting frequency)" beforehand.

- Motor overload early warning -- **OL**
(Function code data = 7)

This output signal is used to issue a motor overload early warning that enables you to take a corrective action before the inverter detects a motor overload alarm \overline{OL} / and shuts down its output. (Refer to the description of E34.)

- Inverter ready to run -- **RDY**
(Function code data = 10)

This output signal comes ON when the inverter becomes ready to run by completing hardware preparation (such as initial charging of DC link bus capacitors and initialization of the control circuit) and no protective functions are activated.

- Frequency arrival signal 2 -- **FAR2**
(Function code data = 21)

This output signal comes ON when a difference between the output frequency before the torque limiting and the reference frequency comes to within the frequency arrival hysteresis width (E30) and then the frequency arrival delay time (E29) has elapsed. (Refer to the descriptions of E29 and E30.)

- Inverter output limiting with delay -- **IOL2**
(Function code data = 22)

If the inverter enters any output limiting operation such as output torque limiting, output current limiting, automatic deceleration (anti-regenerative control), or overload stop (hit mechanical stop), it automatically activates the stall-free facility and shifts the output frequency. When such an output limiting operation continues for 20 ms or more, this output signal comes ON.

This signal is used for lessening the load or alerting the user to an overload status with the monitor.

- Auto-resetting -- **TRY**
(Function code data = 26)

This output signal comes ON when auto-resetting is in progress. The auto-resetting is specified by H04 and H05 (Auto-reset). Refer to the descriptions of H04 and H05 for details about the number of resetting times and reset interval.

- Heat sink overheat early warning -- **OH**
(Function code data = 28)

This output signal is used to issue a heat sink overheat early warning that enables you to take a corrective action before an overheat trip \overline{OH} / actually happens.

This signal comes ON when the temperature of the heat sink exceeds the "overheat trip \overline{OH} / temperature minus 5°C (41°F)," and it goes OFF when it drops down to the "overheat trip \overline{OH} / temperature minus 8°C (46°F)."

- Service life alarm -- **LIFE**
(Function code data = 30)

This output signal comes ON when it is judged that the service life of any one of capacitors (DC link bus capacitors and electrolytic capacitors on the printed circuit board) and cooling fan has expired.

This signal should be used as a guide for replacement of the capacitors and cooling fan. If this signal comes ON, use the specified maintenance procedure to check the service life of these parts and determine whether the parts should be replaced or not.

- Reference loss detected -- **REF OFF**
(Function code data = 33)

This output signal comes ON when an analog input used as a frequency command source is in a reference loss state (as specified by E65) due to a wire break or a weak connection. This signal goes OFF when the operation under the analog input is resumed. (Refer to the description of E65.)

- Inverter output on -- **RUN2**
(Function code data = 35)

This output signal comes ON when the inverter is running at the starting frequency or below or the DC braking is in operation.

- Overload prevention control -- **OLP**
(Function code data = 36)

This output signal comes ON when the overload prevention control is activated. The minimum ON-duration is 100 ms. (Refer to the description of H70.)

- Current detected and Current detected 2 -- **ID** and **ID2**
(Function code data = 37, 38)

The **ID** or **ID2** output signal comes ON when the output current of the inverter exceeds the level specified by E34 (Current detection (Level)) or E37 (Current detection 2 (Level)) for the time longer than the one specified by E35 (Current detection (Timer)) or E38 (Current detection 2 (Timer)), respectively. The minimum ON-duration is 100 ms.

The **ID** or **ID2** goes OFF when the output current drops below 90% of the rated operation level.

These two output signals can be assigned to two different digital output terminals independently if necessary.



Function code E34 is effective for not only the motor overload early warning **OL**, but also for the operation level of the current detection **ID**. (Refer to the description of E34.)

- PID alarm -- **PID-ALM**
(Function code data = 42)

Assigning this output signal enables PID control specified by J11 through J13 to output absolute-value alarm and deviation alarm.

- Switched to motor 2 -- **SWM2**
(Function code data = 49)

This output signal comes ON when motor 2 is selected with the **M2/M1** terminal command assigned to a digital input terminal. For details, refer to the descriptions of E01 through E05 (Function code data = 12).

- Brake signal -- **BRKS**
(Function code data = 57)

This signal outputs a brake control command that releases or activates the brake. Refer to the descriptions of J68 through J72.

- Alarm output (for any alarm) -- **ALM**
(Function code data = 99)

This output signal comes ON if any of the protective functions is activated and the inverter enters Alarm mode.

E29	Frequency Arrival Delay Time (for FAR2)
E30	Frequency Arrival (Hysteresis width for FAR and FAR2)

The moment the output frequency reaches the zone defined by "Reference frequency \pm Hysteresis width specified by E30," the "Frequency arrival signal" **FAR** comes ON.

After the delay time specified by E29, the "Frequency arrival signal 2" **FAR2** comes ON.

For the **FAR** and **FAR2**, refer to the descriptions of E20, E21, and E27.

For details about the operation timings, refer to the graph below.

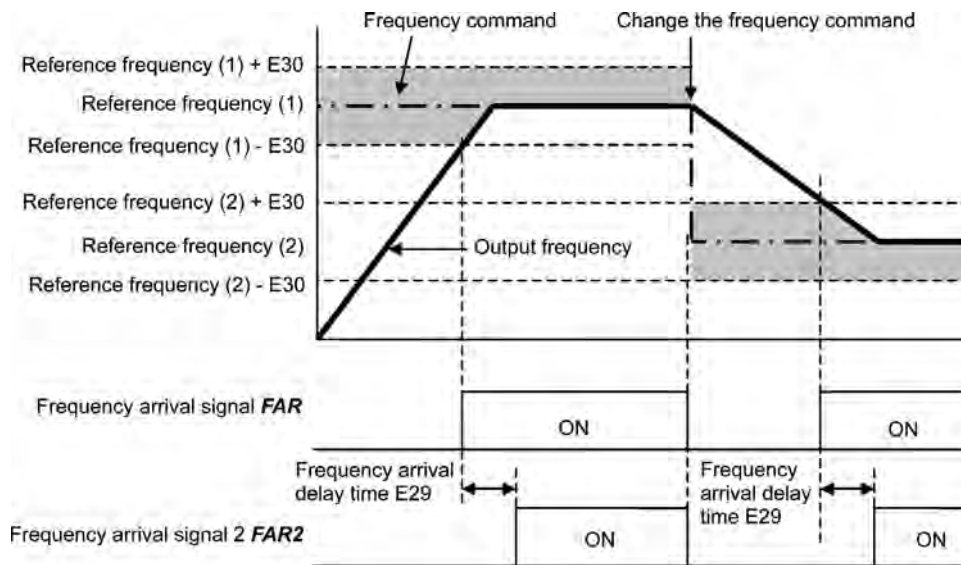

E31	Frequency Detection (Detection level for FDT)
E32	Frequency Detection (Hysteresis width for FDT)

When the output frequency exceeds the frequency detection level specified by E31, the **FDT** signal comes ON; when it drops below the "Frequency detection level minus Hysteresis width specified by E32," it goes OFF.

You need to assign the "Frequency detected" output signal **FDT** (function code data = 2) to one of digital output terminals.

- Data setting range: 0.0 to 400.0 (Hz)

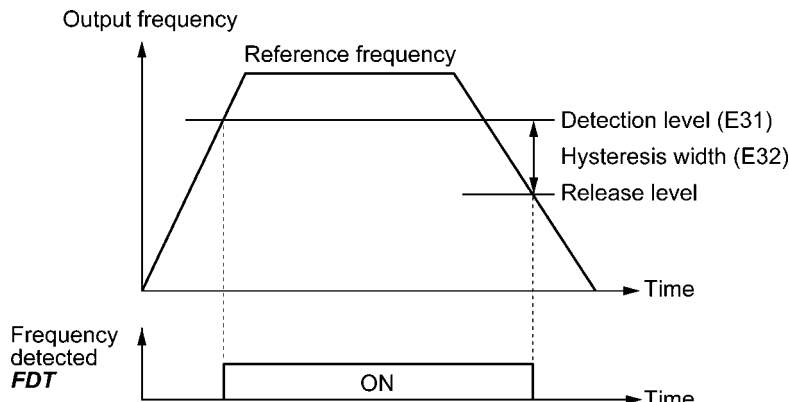

E34	Overload Early Warning/Current Detection (Level)
E35	Overload Early Warning/Current Detection (Timer)
E37	Current Detection 2 (Level)
E38	Current Detection 2 (Timer)

These function codes define the detection level and time for the "Motor overload early warning" **OL**, "Current detected" **ID**, and "Current detected 2" **ID2** output signals.

■ Motor overload early warning signal -- **OL**

The **OL** signal is used to detect a symptom of an overload condition (alarm code \overline{OL} /) of the motor so that the user can take an appropriate action before the alarm actually happens.

The **OL** signal turns ON when the inverter output current has exceeded the level specified by E34. In typical cases, set E34 data to 80 to 90% against F11 data (Electronic thermal overload protection for motor 1, Overload detection level). Specify also the thermal characteristics of the motor with F10 (Select motor characteristics) and F12 (Thermal time constant). To utilize this feature, you need to assign **OL** (data = 7) to any of the digital output terminals.

■ Current detected and Current detected 2 signals -- **ID** and **ID2**

When the inverter output current has exceeded the level specified by E34 or E37 and it continues longer than the period specified by E35 or E38, the **ID** or **ID2** signal turns ON, respectively. When the output current drops below 90% of the rated operation level, the **ID** or **ID2** turns OFF. (Minimum width of the output signal: 100 ms)

To utilize this feature, you need to assign **ID** (data = 37) or **ID2** (data = 38) to any of digital output terminals.

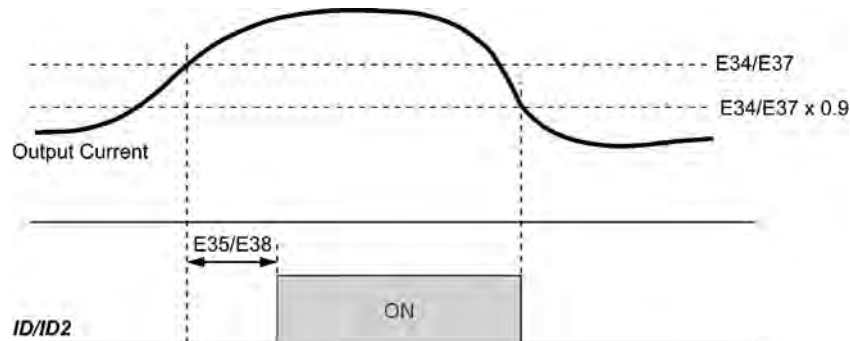

E39**Coefficient for Constant Feeding Rate Time****E50 (Coefficient for Speed Indication)**

E39 and E50 specify coefficients for determining the constant feeding rate time, load shaft speed, and line speed, as well as for displaying the output status monitored.

Calculation expression

$$\text{Constant feeding rate time (min)} = \frac{\text{Coefficient for speed indication (E50)}}{\text{Frequency} \times \text{Coefficient for constant feeding rate time (E39)}}$$

$$\text{Load shaft speed} = \text{Coefficient for speed indication (E50)} \times \text{Frequency (Hz)}$$

$$\text{Line speed} = \text{Coefficient for speed indication (E50)} \times \text{Frequency (Hz)}$$

Where, the "frequency" refers to the "reference frequency" to be applied for settings (constant feeding rate time, load shaft speed, or line speed), or to the "output frequency before slip compensation" to be applied for monitor.

If the constant feeding rate time is 999.9 min. or more or the denominator of the right-hand side is zero (0), "999.9" appears.

E40**PID Display Coefficient A****E41****PID Display Coefficient B**

These function codes specify PID display coefficients A and B to convert a PID command and its feedback into mnemonic physical quantities to display.

- Data setting range: -999 to 0.00 to 9990 for PID display coefficients A and B.

■ Display coefficients for PID process command and its feedback (J01 = 1 or 2)

E40 specifies coefficient A that determines the display value at 100% of the PID process command or its feedback, and E41 specifies coefficient B that determines the display value at 0%.

The display value is determined as follows:

$$\text{Display value} = (\text{PID process command or its feedback (\%)} / 100) \times (\text{Display coefficient A} - \text{B}) + \text{B}$$

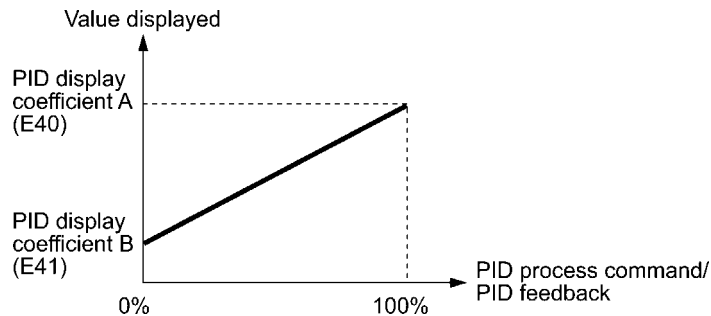
Example

Maintaining the pressure around 16 kPa (sensor voltage 3.13 V) while the pressure sensor can detect 0 to 30 kPa over the output voltage range of 1 to 5 V:

Select terminal [12] as a feedback terminal and set the gain to 200% so that 5 V corresponds to 100%.

The following E40 and E41 settings allow you to monitor or specify the values of the PID process command and its feedback on the keypad as pressure.

E40 = 30.0, that determines the display value at 100% of PID process command or its feedback
 E41 = -7.5, that determines the display value at 0% of PID process command or its feedback

To control the pressure at 16 kPa on the keypad, set the value to 16.0.

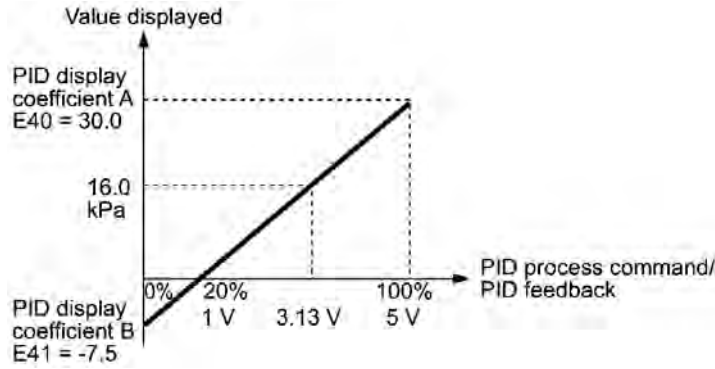

■ Display coefficients for PID dancer positioning command and its feedback (J01 = 3)

Under the PID dancer control, the PID dancer positioning command and its feedback operate the range within $\pm 100\%$, so specify the value at +100% of the PID command or its feedback as coefficient A with E40, and the value at -100% as coefficient B with E41.

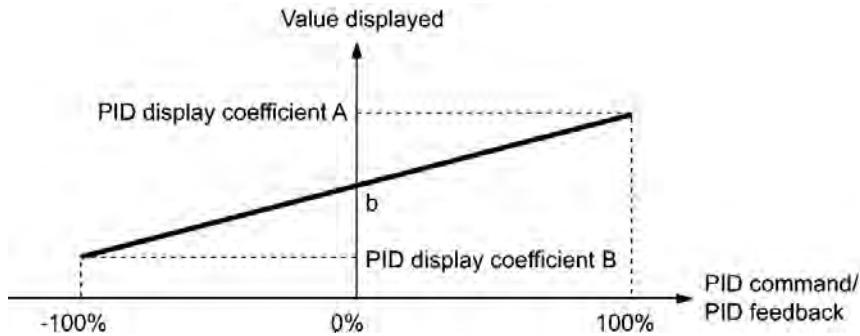

If the sensor output is unipolar, the PID dancer control operates within the range from 0 to +100%, so virtually specify the value at -100% as coefficient B.

That is, suppose "b" = "Display value at 0%," then:

$$\text{Display coefficient B} = 2b - A$$

 For details about the PID control, refer to the description of J01 and later.

 For the display method of the PID command and its feedback, refer to the description of E43.

E42	LED Display Filter
------------	---------------------------

E42 specifies a filter time constant to be applied for displaying the output frequency, output current and other running status monitored on the LED monitor on the keypad. If it is difficult to read data displayed on the monitor due to load fluctuation or other causes, increase this filter time constant.

E43**LED Monitor (Item selection)****E48 (LED Monitor, Item selection)**

E43 specifies the monitoring item to be displayed on the LED monitor.

Data for E43	Function (Displays the following.)	Description
0	Speed monitor	Selected by the sub item of function code E48
3	Output current	Inverter output current expressed in RMS (A)
4	Output voltage	Inverter output voltage expressed in RMS (V)
8	Calculated torque	Output torque of the motor (%)
9	Input power	Inverter's input power (kW)
10	PID command value (frequency) *	Refer to E40 and E41.
12	PID feedback amount *	Refer to E40 and E41.
13	Timer value (for timer operation)	Remaining time of timer operation specified (s)
14	PID output value *	100% at maximum frequency
15	Load factor	Inverter's load factor (%)
16	Motor output	Motor output (kW)

* If 0 (Disable) is set for function code J01, "- - -" appears on the LED monitor.

Specifying the speed monitor with E43 provides a choice of speed-monitoring formats selectable with E48 (LED Monitor).

Define the speed-monitoring format on the LED monitor as listed below.

Data for E48	Display format of the sub item	
0	Output frequency (before slip compensation)	Expressed in Hz
1	Output frequency (after slip compensation)	Expressed in Hz
2	Reference frequency	Expressed in Hz
3	Motor speed in r/min	$120 \div \text{Number of poles (P01)} \times \text{Frequency (Hz)}$
4	Load shaft speed in r/min	$\text{Coefficient for speed indication (E50)} \times \text{Frequency (Hz)}$
5	Line speed in m/min	$\text{Coefficient for speed indication (E50)} \times \text{Frequency (Hz)}$
6	Constant feeding rate time (min)	$\text{Coefficient for speed indication (E50)} \div (\text{Frequency (Hz)} \times \text{Coefficient for constant feeding rate time (E39)})$

E45 LCD Monitor (Item selection)

E45 specifies the LCD monitor display mode to be applied when the inverter using the multi-function keypad is in Running mode.

Data for E45	Function
0	Running status, rotational direction and operation guide
1	Bar charts for output frequency, current and calculated torque

Example of display for E45 = 0 (during running)

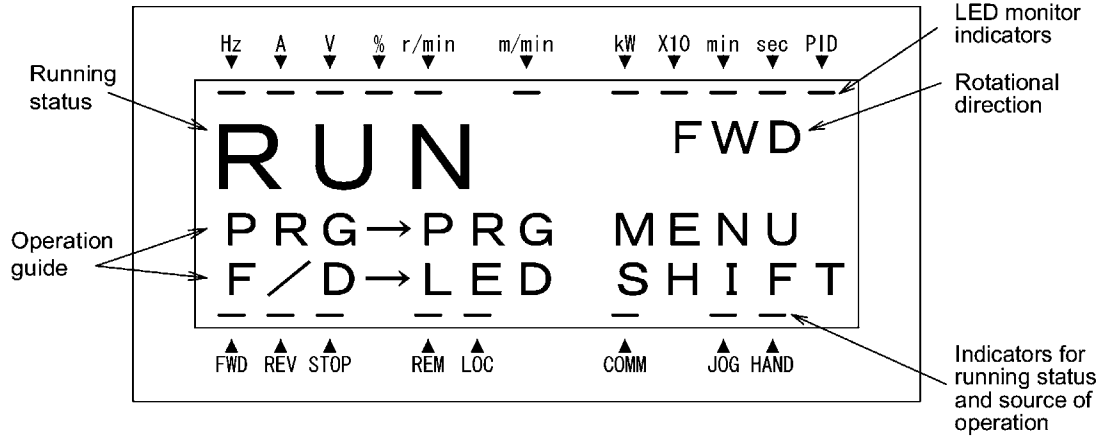

Example of display for E45 = 1 (during running)

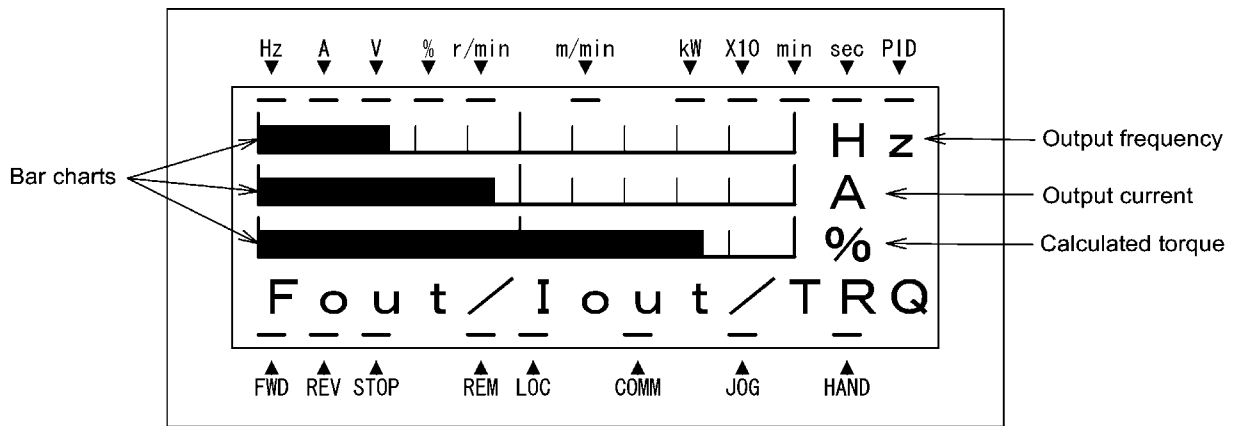

Full-scale values on bar charts

Item displayed	Full scale
Output frequency	Maximum frequency (F03/A01)
Output current	Inverter rated current × 200%
Calculated torque	Motor rated torque × 200%

E46**LCD Monitor (Language selection)**

E46 specifies the language to display on the multi-function keypad as follows:

Data for E46	Language
0	Japanese
1	English
2	German
3	French
4	Spanish
5	Italian

E47**LCD Monitor (Contrast control)**

E47 adjusts the contrast of the LCD monitor on the multi-function keypad as follows:

Data for E47	0, 1, 2, 3, 4, 5, 6, 7, 8, 9, 10
Contrast	Low \longleftrightarrow High

E48**LED Monitor (Speed monitor item)****E43 (LED Monitor, Item selection)**

Refer to the description of E43.

E50**Coefficient for Speed Indication****E39 (Coefficient for Constant Feeding Rate Time)**

Refer to the description of E39.

E51**Display Coefficient for Input Watt-hour Data**

E51 specifies a display coefficient (multiplication factor) for displaying the input watt-hour data ($\overline{5}$ $\overline{1}$) in a part of maintenance information on the keypad.

Input watt-hour data = Display coefficient (E51 data) \times Input watt-hour (kWh)



Setting E51 data to 0.000 clears the input watt-hour and its data to "0." After clearing, be sure to restore E51 data to the previous value; otherwise, input watt-hour data will not be accumulated.

E52	Keypad (Menu display mode)
------------	-----------------------------------

E52 provides a choice of three menu display modes for the standard keypad as listed below.

Data for E52	Menu display mode	Menus to be displayed
0	Function code data editing mode	Menus #0 and #1
1	Function code data check mode	Menu #2
2	Full-menu mode	Menus #0 through #6

Note The multi-function keypad always displays all the menu items (including additional menu items) regardless of the E52 data.

The menus available on the standard keypad are described below.

Menu	Menu	LED monitor shows:	Main functions
#0	"Quick Setup"	<i>Q.F.F.C</i>	Displays only basic function codes to customize the inverter operation.
#1	"Data Setting"	<i>F--</i>	F codes (Fundamental functions)
		<i>E--</i>	E codes (Extension terminal functions)
		<i>C--</i>	C codes (Control functions)
		<i>P--</i>	P codes (Motor 1 parameters)
		<i>H--</i>	H codes (High performance functions)
		<i>A--</i>	A codes (Motor 2 parameters)
		<i>U--</i>	J codes (Application functions)
		<i>Y--</i>	y codes (Link functions)
		<i>o--</i>	o codes (Optional function)
#2	"Data Checking"	<i>2.C.E.P</i>	Displays only function codes that have been changed from their factory defaults. You can refer to or change those function code data.
#3	"Drive Monitoring"	<i>3.D.P.E</i>	Displays the running information required for maintenance or test running.
#4	"I/O Checking"	<i>4.I.O</i>	Displays external interface information.
#5	"Maintenance Information"	<i>5.C.H.E</i>	Displays maintenance information including accumulated run time.
#6	"Alarm Information"	<i>6.A.L</i>	Displays the latest four alarm codes. You can refer to the running information at the time when the alarm occurred.

For details of each menu item, refer to Chapter 3 "OPERATION USING THE KEYPAD."

E59**Terminal [C1] Signal Definition (C1/V2 function)**

E59 defines the property of terminal [C1] for either a current input +4 to +20 mA DC (C1 function) or a voltage input 0 to +10 VDC (V2 function). In addition to this setting, you need to turn SW7 on the interface PCB to the corresponding position as listed below.

Data for E59	Input configuration	SW7 position
0	Current input: 4 to 20 mA DC (C1 function)	C1
1	Voltage input: 0 to +10 VDC (V2 function)	V2

 **Note** To use terminal [C1] for the PTC thermistor input, set E59 data to 0.

E61**Terminal [12] Extended Function****E62****Terminal [C1] Extended Function (C1 function)****E63****Terminal [C1] Extended Function (V2 function)**

E61, E62, and E63 define the property of terminals [12], [C1] (C1 function), and [C1] (V2 function), respectively.

There is no need to set up these terminals if they are to be used for frequency command sources.

Data for E61, E62, or E63	Function	Description
0	None	--
1	Auxiliary frequency command 1	This is an auxiliary analog frequency input to be added to frequency command 1 (F01). It is never added to frequency command 2, multi-frequency command or other frequency commands.
2	Auxiliary frequency command 2	This is an auxiliary analog frequency input to be added to all frequency commands including frequency command 1, frequency command 2 and multi-frequency commands.
3	PID command 1	This input includes temperature, pressure or other commands to apply under the PID control. Function code J02 should be also configured.
5	PID feedback amount	This input includes the feedback of the temperature or pressure under the PID control.

 **Note** If these terminals have been set up to have the same data, the operation priority is given in the following order:

E61 > E62 > E63

Selecting the **UP/DOWN** control (F01, C30 = 7) ignores auxiliary frequency command 1 and 2.

E65	Reference Loss Detection (Continuous running frequency)
------------	--

When the analog frequency command (entered through terminals [12] and [C1] (C1/V2 function)) has dropped below 10% of the expected frequency command within 400 ms, the inverter presumes that the analog frequency command wire has been broken and continues its operation at the frequency determined by the ratio specified by E65 to the reference frequency. When the frequency command level (in voltage or current) returns to a level higher than that specified by E65, the inverter presumes that the broken wire has been fixed and continues to run following the frequency command.

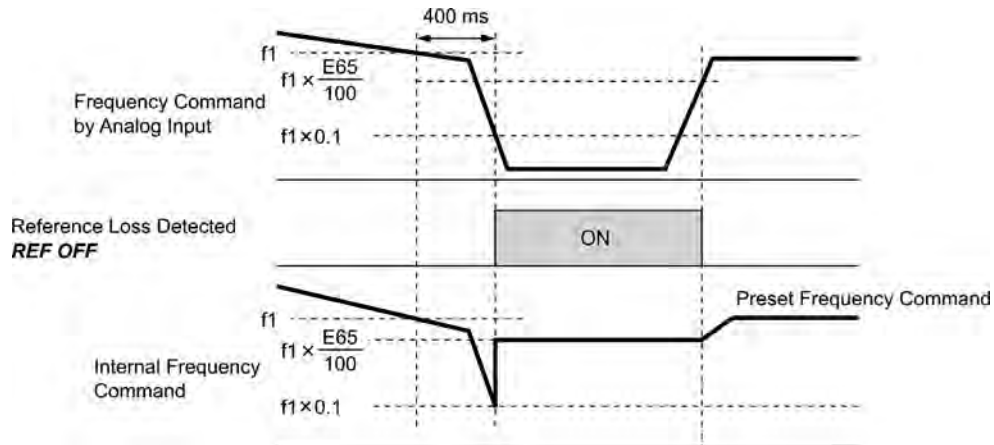

In the diagram above, $f1$ is the level of the analog frequency command sampled at any given time. The sampling is repeated at regular intervals to continually monitor the wiring connection of the analog frequency command.

Note Avoid an abrupt voltage or current change for the analog frequency command. The abrupt change may be interpreted as a wire break.

Setting E65 data at "999" (Disable) allows the "Reference loss detected" signal **REF OFF** to be issued, but does not allow the reference frequency to change (the inverter runs at the analog frequency command as specified).

When E65 = "0" or "999," the reference frequency level at which the broken wire is recognized as fixed is " $f1 \times 0.2$."

When E65 = "100" (%) or higher, the reference frequency level at which the broken wire is recognized as fixed is " $f1 \times 1$."

The reference loss detection is not affected by the setting of analog input adjustment (filter time constants: C33, C38, and C43).

E98	Terminal [FWD] Function	E01 to E05 (Terminal [X1] to [X5] Function)
E99	Terminal [REV] Function	E01 to E05 (Terminal [X1] to [X5] Function)

For details about command assignment to terminals [FWD] and [REV], refer to the descriptions of E01 to E05.

9.2.3 C codes (Control functions)

C01 to C03	Jump Frequency 1, 2 and 3
C04	Jump Frequency (Hysteresis width)

These function codes enable the inverter to jump over three different points on the output frequency in order to skip resonance caused by the motor speed and natural frequency of the driven machinery.

- While you are increasing the reference frequency, the moment the reference frequency reaches the bottom of the jump frequency band, the inverter keeps the output at that bottom frequency. When the reference frequency exceeds the upper limit of the jump frequency band, the internal reference frequency takes on the value of the reference frequency. When you are decreasing the reference frequency, the situation will be reversed.
- When more than two jump frequency bands overlap, the inverter actually takes the lowest frequency within the overlapped bands as the bottom frequency and the highest as the upper limit. Refer to the figure on the lower right.

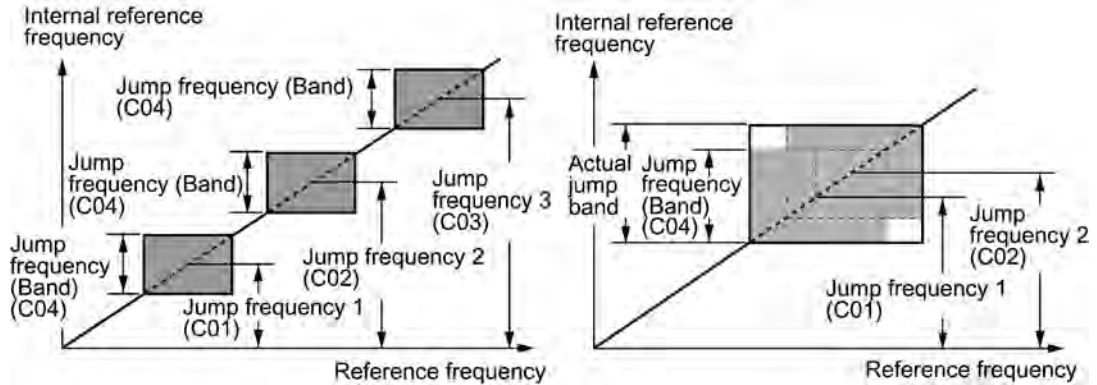

■ Jump frequencies 1, 2 and 3 (C01, C02 and C03)

Specify the center of the jump frequency band.

- Data setting range: 0.0 to 400.0 (Hz) (Setting to 0.0 results in no jump frequency band.)

■ Jump frequency hysteresis width (C04)

Specify the jump frequency hysteresis width.

- Data setting range: 0.0 to 30.0 (Hz) (Setting to 0.0 results in no jump frequency band.)

C05 to C19**Multi-frequency 1 to 15**

- These function codes specify 15 frequencies required for driving the motor at frequencies 1 to 15.

Turning terminal commands *SS1*, *SS2*, *SS4* and *SS8* ON/OFF selectively switches the reference frequency of the inverter in 15 steps. For details of the terminal function assignment, refer to the descriptions for function codes E01 to E05 "Terminal [X1] to [X5] Function."

- Data setting range: 0.00 to 400.0 (Hz)

The combination of *SS1*, *SS2*, *SS4* and *SS8* and the selected frequencies are as follows.

<i>SS8</i>	<i>SS4</i>	<i>SS2</i>	<i>SS1</i>	Selected frequency command
OFF	OFF	OFF	OFF	Other than multi-frequency *
OFF	OFF	OFF	ON	C05 (multi-frequency 1)
OFF	OFF	ON	OFF	C06 (multi-frequency 2)
OFF	OFF	ON	ON	C07 (multi-frequency 3)
OFF	ON	OFF	OFF	C08 (multi-frequency 4)
OFF	ON	OFF	ON	C09 (multi-frequency 5)
OFF	ON	ON	OFF	C10 (multi-frequency 6)
OFF	ON	ON	ON	C11 (multi-frequency 7)
ON	OFF	OFF	OFF	C12 (multi-frequency 8)
ON	OFF	OFF	ON	C13 (multi-frequency 9)
ON	OFF	ON	OFF	C14 (multi-frequency 10)
ON	OFF	ON	ON	C15 (multi-frequency 11)
ON	ON	OFF	OFF	C16 (multi-frequency 12)
ON	ON	OFF	ON	C17 (multi-frequency 13)
ON	ON	ON	OFF	C18 (multi-frequency 14)
ON	ON	ON	ON	C19 (multi-frequency 15)

* "Other than multi-frequency" includes frequency command 1 (F01), frequency command 2 (C30) and other command sources except multi-frequency commands.

To use these features, you need to assign multi-frequency selections *SS1*, *SS2*, *SS4* and *SS8* (data = 0, 1, 2, and 3) to the digital input terminals.



For the relationship between multi-frequency operation and other frequency commands, refer to Section 4.2 "Drive Frequency Command Block."

■ When enabling PID control (J01 = 1, 2, or 3)

Under the PID control, a multi-frequency command can be specified as a preset value (3 different frequencies). It can also be used for a manual speed command even with the PID control being canceled (*Hz/PID* = ON) or for a primary reference frequency under the PID dancer control.

• PID command

<i>SS8</i>	<i>SS4</i>	<i>SS1, SS2</i>	Command
OFF	OFF	–	Command specified by J02
OFF	ON	–	Multi-frequency by C08
ON	OFF	–	Multi-frequency by C12
ON	ON	–	Multi-frequency by C16

C08, C12, and C16 can be specified in increments of 1 Hz. The following gives the conversion formula between the PID command value and the data to be specified.

Data to be specified = PID command (%) × Maximum frequency (F03) ÷ 100

$$\text{PID command (\%)} = \frac{\text{Data to be specified (C08/C12/C16)}}{\text{Maximum frequency (F03)}} \times 100$$

• Manual speed command

<i>SS8, SS4</i>	<i>SS2</i>	<i>SS1</i>	Selected frequency
–	OFF	OFF	Other than multi-frequency
–	OFF	ON	C05 (Multi-frequency 1)
–	ON	OFF	C06 (Multi-frequency 2)
–	ON	ON	C07 (Multi-frequency 3)

 For PID commands, refer to the block diagrams in Chapter 4, Section 4.5 "PID Process Control Block" and Section 4.6 "PID Dancer Control Block."

C20

Jogging Frequency

C20 specifies the frequency to apply in jogging operation.

- Data setting range: 0.00 to 400.0 (Hz)

 For details about jogging (inching) operation, refer to the descriptions of E01 to E05 "Terminal [X1] to [X5] Function."

C21**Timer Operation**

C21 enables or disables a timer operation that is triggered by a run command and continues for the timer count previously specified with the \wedge / \vee keys. The operating procedure for the timer operation is given below.

Data for C21	Function
0	Disable timer operation
1	Enable timer operation

- Tip**
- Pressing the STOP key during timer countdown quits the timer operation.
 - Even if C21 = 1, setting the timer to 0 no longer starts the timer operation with the RUN key.
 - Applying terminal command *FWD* or *REV* instead of the key command can also start the timer operation.

Operating procedure for timer operation (example)**Preparation**

- Set E43 data to "13" (LED monitor) to display the timer count on the LED monitor and set C21 to "1" (Enable timer operation).
- Specify the reference frequency to apply to timer operation. When the keypad is selected as a frequency command source, press the FUNC/DATA key to shift to the speed monitor and specify the desired reference frequency.

Triggering the timer operation with the RUN key

- While watching the timer count displayed on the LED monitor, press the \wedge / \vee key to set the timer for the desired count in seconds. Note that the timer count on the LED monitor appears as an integral number without a decimal point.
- Press the RUN key. The motor starts running and the timer starts counting down. If the timer counts down, the motor stops without pressing the STOP key. (Even if the LED monitor displays any item except the timer count, the timer operation is possible.)

Note After the countdown of the timer operation triggered by a terminal command such as *FWD*, the inverter decelerates to stop and at that moment the LED monitor displays ERR and any LED monitor item (L7 for the timer count) alternately. Turning *FWD* OFF returns to the LED monitor item.

C30**Frequency Command 2****F01 (Frequency Command 1)**

For details of frequency command 2, refer to the description of F01.

C31	Analog Input Adjustment for [12] (Offset) C33 (Analog Input Adjustment for [12], Filter time constant) C36 (Analog Input Adjustment for [C1] (C1 function), Offset) C38 (Analog Input Adjustment for [C1] (C1 function), Filter time constant) C41 (Analog Input Adjustment for [C1] (V2 function), Offset) C43 (Analog Input Adjustment for [C1] (V2 function), Filter time constant)
------------	--

C31, C36 or C41 configures an offset for an analog voltage/current input at terminal [12], [C1] (C1 function) or [C1] (V2 function), respectively. The table below summarizes their interrelation. The offset also applies to signals sent from the external equipment.

Analog input	Offset control	Input filter time constant
Terminal [12]	C31	C33
Terminal [C1] (C1 function)	C36	C38
Terminal [C1] (V2 function)	C41	C43

C33, C38 or C43 configures a filter time constant for an analog voltage/current input at terminal [12], [C1] (C1 function) or [C1] (V2 function), respectively. The larger the time constant, the slower the response. Specify the proper filter time constant taking into account the response speed of the machine (load). If the input voltage fluctuates due to line noises, increase the time constant.

C32	Analog Input Adjustment for [12] (Gain)	F18 (Bias, Frequency command 1)
------------	--	--

Refer to the description of F18.

C33	Analog Input Adjustment for [12] (Filter time constant) C31 (Analog Input Adjustment for [12], Offset)
------------	--

Refer to the description of C31.

C34	Analog Input Adjustment for [12] (Gain base point)	F18 (Bias, Frequency command 1)
------------	---	--

Refer to the description of F18.

C35	Analog Input Adjustment for [12] (Polarity)
------------	--

To use terminal [12] with an input -10 to +10 VDC, set this function code data to "0." If C35 = 1, a minus component of the input will be regarded as 0 VDC inside the inverter.

Data for C35	Polarity	Input range allowable to terminal [12]
0	Bipolar	-10 to +10 VDC
1	Unipolar	0 to +10 VDC

C36	Analog Input Adjustment for [C1] (C1 function) (Offset) C31 (Analog Input Adjustment for [12], Offset)
------------	--

Refer to the description of C31.

C37	Analog Input Adjustment for [C1] (C1 function) (Gain) F18 (Bias, Frequency command 1)
------------	---

Refer to the description of F18.

C38	Analog Input Adjustment for [C1] (C1 function) (Filter time constant) C31 (Analog Input Adjustment for [12], Offset)
------------	--

Refer to the description of C31.

C39	Analog Input Adjustment for [C1] (C1 function) (Gain base point) F18 (Bias, Frequency command 1)
------------	--

Refer to the description of F18.

C41	Analog Input Adjustment for [C1] (V2 function) (Offset) C31 (Analog Input Adjustment for [12], Offset)
------------	--

Refer to the description of C31.

C42	Analog Input Adjustment for [C1] (V2 function) (Gain) F18 (Bias, Frequency command 1)
------------	---

Refer to the description of F18.

C43	Analog Input Adjustment for [C1] (V2 function) (Filter time constant) C31 (Analog Input Adjustment for [12], Offset)
------------	--

Refer to the description of C31.

C44	Analog Input Adjustment for [C1] (V2 function) (Gain base point) F18 (Bias, Frequency command 1)
------------	--

Refer to the description of F18.

C50	Bias (Frequency command 1) (Bias base point) F18 (Bias, Frequency command 1)
------------	--

For details about bias base point setting for frequency command 1, refer to the description of F18.

C51	Bias (PID command 1) (Bias value)
C52	Bias (PID command 1) (Bias base point)

These function codes specify the bias and bias base point of the analog PID command 1, enabling it to define arbitrary relationship between the analog input and PID commands.

 The actual setting is the same as that of function code F18. For details, refer to the description of F18.

 Note that function codes C32, C34, C37, C39, C42, and C44 are shared by frequency commands.

- Bias value (C51)
 - Data setting range: -100.00 to 100.00 (%)
- Bias base point (C52)
 - Data setting range: 0.00 to 100.00 (%)

C53	Selection of Normal/Inverse Operation (Frequency command 1)
------------	--

C53 switches the reference frequency sourced by frequency command 1 (F01) between normal and inverse.

 For details, refer to the descriptions of E01 through E05, "Switch normal/inverse operation" terminal command *IVS* (function code data = 21).

9.2.4 P codes (Motor 1 parameters)

P01**Motor 1 (No. of poles)****A15 (Motor 2, No. of poles)**

P01 specifies the number of poles of the motor. Enter the value given on the nameplate of the motor. This setting is used to display the motor speed on the LED monitor (refer to E43). The following expression is used for the conversion.

$$\text{Motor speed (r/min)} = \frac{120}{\text{No. of poles}} \times \text{Frequency (Hz)}$$

P02**Motor 1 (Rated capacity)****A16 (Motor 2, Rated capacity)**

P02 specifies the rated capacity of the motor. Enter the rated value given on the nameplate of the motor.

Data for P02	Unit	Remarks
0.01 to 30.00	kW	When P99 = 0, 3 or 4
	HP	When P99 = 1

P03**Motor 1 (Rated current)****A17 (Motor 2, Rated current)**

P03 specifies the rated current of the motor. Enter the rated value given on the nameplate of the motor.

P04**Motor 1 (Auto-tuning)****A18 (Motor 2, Auto-tuning)**

The inverter automatically detects the motor parameters and saves them in its internal memory. Basically, it is not necessary to perform tuning when using a Fuji standard motor with a standard connection with the inverter.

In any of the following cases, perform auto-tuning since the motor parameters are different from those of Fuji standard motors so as not to obtain the best performance under each of these controls--auto torque boost, torque calculation monitoring, auto energy saving operation, torque limiter, automatic deceleration (anti-regenerative control), auto search for idling motor speed, slip compensation, torque vector, droop control, or overload stop.

- The motor to be driven is made by other manufacturer or is a non-standard motor.
- Cabling between the motor and the inverter is long.
- A reactor is inserted between the motor and the inverter.



For details of auto-tuning, refer to the FRENIC-Multi Instruction Manual, Section 4.1.3 "Preparation before running the motor for a test -- Setting function code data."

P05**Motor 1 (Online tuning)****A19 (Motor 2, Online tuning)**

The primary and secondary % resistances (%R1) and (%R2) will change as the motor temperature rises. P05 allows you to tune this change when the inverter is in operation (online).

P06	Motor 1 (No-load current)	P12 (Motor 1, Rated slip frequency) A20 (Motor 2, No-load current)
P07	Motor 1 (%R1)	A21 (Motor 2, %R1)
P08	Motor 1 (%X)	A22 (Motor 2, %X)

P06 through P08 and P12 specify no-load current, %R1, %X, and rated slip frequency, respectively. Obtain the appropriate values from the test report of the motor or by calling the manufacturer of the motor.

Performing auto-tuning automatically sets these parameters.

■ **No-load current (P06)**

Enter the value obtained from the motor manufacturer.

■ **%R1 (P07)**

Enter the value calculated by the following expression.

$$\%R1 = \frac{R1 + \text{Cable } R1}{V / (\sqrt{3} \times I)} \times 100 (\%)$$

where,

R1: Primary resistance of the motor (Ω)

Cable R1: Resistance of the output cable (Ω)

V: Rated voltage of the motor (V)

I: Rated current of the motor (A)

■ **%X (P08)**

Enter the value calculated by the following expression.

$$\%X = \frac{X1 + X2 \times XM / (X2 + XM) + \text{Cable } X}{V / (\sqrt{3} \times I)} \times 100 (\%)$$

where,

X1: Primary leakage reactance of the motor (Ω)

X2: Secondary leakage reactance of the motor (converted to primary) (Ω)

XM: Exciting reactance of the motor (Ω)

Cable X: Reactance of the output cable (Ω)

V: Rated voltage of the motor (V)

I: Rated current of the motor (A)

■ **Rated slip frequency (P12)**

Convert the value obtained from the motor manufacturer to Hz using the following expression and enter the converted value. (Note: The motor rating given on the nameplate sometimes shows a larger value.)

$$\text{Rated slip frequency (Hz)} = \frac{(\text{Synchronous speed} - \text{Rated speed})}{\text{Synchronous speed}} \times \text{Base frequency}$$

 For reactance, choose the value at the base frequency 1 (F04).

P09	Motor 1 (Slip compensation gain for driving) A23 (Motor 2, Slip compensation gain for driving)
P10	Motor 1 (Slip compensation response time) A24 (Motor 2, Slip compensation response time)
P11	Motor 1 (Slip compensation gain for braking) A25 (Motor 2, Slip compensation gain for braking)

P09 and P11 determine the slip compensation amount in % for driving and braking individually. Specification of 100% fully compensates for the rated slip of the motor. Excessive compensation (P09, P11 > 100%) may cause a system oscillation, so carefully check the operation on the actual machine.

P10 determines the response time for slip compensation. Basically, there is no need to modify the default setting. If you need to modify it, consult your Fuji Electric representatives.

P12	Motor 1 (Rated slip frequency)	P06 (Motor 1, No-load current) P07 (Motor 1, %R1) P08 (Motor 1, %X) A26 (Motor 2, Rated slip frequency)
------------	---------------------------------------	--

For details about setting of the rated slip frequency of motor 1, refer to the descriptions of P06 to P08.

P99	Motor 1 Selection	A39 (Motor 2 Selection)
------------	--------------------------	--------------------------------

P99 specifies the motor to be used.

Data for P99	Motor type
0	Motor characteristics 0 (Fuji standard motors, 8-series)
1	Motor characteristics 1 (HP rating motors)
3	Motor characteristics 3 (Fuji standard motors, 6-series)
4	Other motors

Automatic control (such as auto torque boost and auto energy saving) or electronic thermal overload protection for motor uses the motor parameters and characteristics. To match the property of a control system with that of the motor, select characteristics of the motor and set H03 data (Data Initialization) to "2" to initialize the old motor parameters stored in the inverter. When initialization is complete, P03, P06, P07, and P08 data and the old related internal data are automatically updated.

For P99, enter the following data according to the motor type.

- P99 = 0 (Motor characteristics 0): Fuji standard 8-series motors (Current standard)
- P99 = 3 (Motor characteristics 3): Fuji standard 6-series motors (Conventional standard)
- P99 = 4 (Other motors): Other manufacturer's or unknown motors







- If P99 = 4 (Other motors), the inverter runs following the motor characteristics of Fuji standard 8-series.
- The inverter also supports motors rated by HP (horse power: typical in North America, P99 = 1).

9.2.5 H codes (High performance functions)

H03

Data Initialization

H03 initializes the current function code data to the factory defaults or initializes the motor parameters.

To change the H03 data, it is necessary to press the  +  keys or  +  keys (simultaneous keying).

Data for H03	Function
0	Disable initialization (Settings manually made by the user will be retained.)
1	Initialize all function code data to the factory defaults
2	Initialize motor 1 parameters in accordance with P02 (Rated capacity) and P99 (Motor 1 selection) Function codes subject to initialization: P01, P03, P06 to P12 and constants for internal control (These function codes will be initialized to the values listed in tables on the following pages.)
3	Initialize motor 2 parameters in accordance with A16 (Rated capacity) and A39 (Motor 2 selection) Function codes subject to initialization: A15, A17, A20 to A26 and constants for internal control (These function codes will be initialized to the values listed in tables on the following pages.)

- To initialize the motor parameters, set the related function codes as follows.
 - 1) P02/A16 Set the rated capacity of the motor to be used in kW.
Motor (Rated capacity)
 - 2) P99/A39 Select the characteristics of the motor.
Motor Selection
 - 3) H03 Data Initialization Initialize the motor parameters. (H03 = 2 or 3)
 - 4) P03/A17 Set the rated current on the nameplate if the already set
Motor (Rated current) data differs from the rated current printed on the nameplate
of the motor.
- Upon completion of the initialization, the H03 data reverts to "0" (factory default).
- If the P02 or A16 data is set to a value other than the nominal applied motor rating, data initialization with H03 internally converts the specified value forcedly to the equivalent nominal applied motor rating (see the tables on the following pages).
- If initialized, motor parameters revert to the default data specified for each of the V/f settings listed below. To use motors whose base frequency, rated voltage or number of poles is different, non-Fuji motors, or other series of motors, change the data to the rated current printed on the nameplate.

P99 = 0 or 4	: Fuji standard, 8 series motor	(4 poles, 200 V/50 Hz or 400 V/50 Hz)
P99 = 3	: Fuji standard, 6 series motor	(4 poles, 200 V/50 Hz or 400 V/50 Hz)
P99 = 1	: HP rating motor	(4 poles, 230 V/60 Hz or 460 V/60 Hz)

- When Fuji standard 8-series motors (P99 = 0 or A39 = 0) or other motors (P99 = 4 or A39 = 4) are selected, the motor parameters are as listed in the following tables.

230 V (Example for FRN__E1□-2U)

Motor capacity (kW)	Nominal applied motor (kW)	Rated current (A)	No-load current (A)	%R (%)	%X (%)	Rated slip frequency (Hz)
P02/A16		P03/A17	P06/A20	P07/A21	P08/A22	P12/A26
0.01 to 0.09	0.06	0.44	0.40	13.79	11.75	1.77
0.10 to 0.19	0.1	0.68	0.55	12.96	12.67	1.77
0.20 to 0.39	0.2	1.30	1.06	12.95	12.92	2.33
0.40 to 0.74	0.4	2.30	1.66	10.20	13.66	2.40
0.75 to 1.49	0.75	3.60	2.30	8.67	10.76	2.33
1.50 to 2.19	1.5	6.10	3.01	6.55	11.21	2.00
2.20 to 3.69	2.2	9.20	4.85	6.48	10.97	1.80
3.70 to 5.49	3.7	15.0	7.67	5.79	11.25	1.93
5.50 to 7.49	5.5	22.5	11.0	5.28	14.31	1.40
7.50 to 10.99	7.5	29.0	12.5	4.50	14.68	1.57
11.00 to 14.99	11	42.0	17.7	3.78	15.09	1.07
15.00 to 18.49	15	55.0	20.0	3.25	16.37	1.13
18.50 to 21.99	18.5	67.0	21.4	2.92	16.58	0.87
22.00 to 30.00	22	78.0	25.1	2.70	16.00	0.90

460 V (Example for FRN__E1□-4U)

Motor capacity (kW)	Nominal applied motor (kW)	Rated current (A)	No-load current (A)	%R (%)	%X (%)	Rated slip frequency (Hz)
P02/A16		P03/A17	P06/A20	P07/A21	P08/A22	P12/A26
0.01 to 0.09	0.06	0.22	0.20	13.79	11.75	1.77
0.10 to 0.19	0.10	0.35	0.27	12.96	12.67	1.77
0.20 to 0.39	0.20	0.65	0.53	12.95	12.92	2.33
0.40 to 0.74	0.4	1.15	0.83	10.20	13.66	2.40
0.75 to 1.49	0.75	1.80	1.15	8.67	10.76	2.33
1.50 to 2.19	1.5	3.10	1.51	6.55	11.21	2.00
2.20 to 3.69	2.2	4.60	2.43	6.48	10.97	1.80
3.70 to 5.49	3.7	7.50	3.84	5.79	11.25	1.93
5.50 to 7.49	5.5	11.5	5.50	5.28	14.31	1.40
7.50 to 10.99	7.5	14.5	6.25	4.50	14.68	1.57
11.00 to 14.99	11	21.0	8.85	3.78	15.09	1.07
15.00 to 18.49	15	27.5	10.0	3.25	16.37	1.13
18.50 to 21.99	18.5	34.0	10.7	2.92	16.58	0.87
22.00 to 30.00	22	39.0	12.6	2.70	16.00	0.90

- When Fuji standard 6-series motors (P99 = 3, or A39 = 3) are selected, the motor parameters are as listed in the following tables.

230 V (Example for FRN_ _ _E1□-2U)

Motor capacity (kW)	Nominal applied motor (kW)	Rated current (A)	No-load current (A)	%R (%)	%X (%)	Rated slip frequency (Hz)
P02/A16		P03/A17	P06/A20	P07/A21	P08/A22	P12/A26
0.01 to 0.09	0.06	0.44	0.40	13.79	11.75	1.77
0.10 to 0.19	0.1	0.68	0.55	12.96	12.67	1.77
0.20 to 0.39	0.2	1.30	1.00	12.61	13.63	2.33
0.40 to 0.74	0.4	2.30	1.56	10.20	14.91	2.40
0.75 to 1.49	0.75	3.60	2.35	8.67	10.66	2.33
1.50 to 2.19	1.5	6.10	3.00	6.55	11.26	2.00
2.20 to 3.69	2.2	9.20	4.85	6.48	10.97	1.80
3.70 to 5.49	3.7	15.0	7.70	5.79	11.22	1.93
5.50 to 7.49	5.5	22.2	10.7	5.09	13.66	1.40
7.50 to 10.99	7.5	29.0	12.5	4.50	14.70	1.57
11.00 to 14.99	11	42.0	17.6	3.78	15.12	1.07
15.00 to 18.49	15	55.0	20.0	3.24	16.37	1.13
18.50 to 21.99	18.5	67.0	21.9	2.90	17.00	0.87
22.00 to 30.00	22	78.0	25.1	2.70	16.05	0.90

460 V (Example for FRN_ _ _E1□-4U)

Motor capacity (kW)	Nominal applied motor (kW)	Rated current (A)	No-load current (A)	%R (%)	%X (%)	Rated slip frequency (Hz)
P02/A16		P03/A17	P06/A20	P07/A21	P08/A22	P12/A26
0.01 to 0.09	0.06	0.22	0.20	13.79	11.75	1.77
0.10 to 0.19	0.10	0.35	0.27	12.96	12.67	1.77
0.20 to 0.39	0.20	0.65	0.50	12.61	13.63	2.33
0.40 to 0.74	0.4	1.20	0.78	10.20	14.91	2.40
0.75 to 1.49	0.75	1.80	1.18	8.67	10.66	2.33
1.50 to 2.19	1.5	3.10	1.50	6.55	11.26	2.00
2.20 to 3.69	2.2	4.60	2.43	6.48	10.97	1.80
3.70 to 5.49	3.7	7.50	3.85	5.79	11.22	1.93
5.50 to 7.49	5.5	11.0	5.35	5.09	13.66	1.40
7.50 to 10.99	7.5	14.5	6.25	4.50	14.70	1.57
11.00 to 14.99	11	21.0	8.80	3.78	15.12	1.07
15.00 to 18.49	15	27.5	10.0	3.24	16.37	1.13
18.50 to 21.99	18.5	34.0	11.0	2.90	17.00	0.87
22.00 to 30.00	22	39.0	12.6	2.70	16.05	0.90

- When HP rating motors (P99 = 1 or A39 = 1) are selected, the motor parameters are as listed in the following tables.

(HP stands for "horsepower," which is a unit for motor power mainly used in US.)

230 V

Motor capacity (HP)	Nominal applied motor (HP)	Rated current (A)	No-load current (A)	%R (%)	%X (%)	Rated slip frequency (Hz)
P02/A16		P03/A17	P06/A20	P07/A21	P08/A22	P12/A26
0.01 to 0.11	1.10	0.44	0.40	13.79	11.75	2.50
0.12 to 0.24	0.12	0.68	0.55	12.96	12.67	2.50
0.25 to 0.49	0.25	1.40	1.12	11.02	13.84	2.50
0.50 to 0.99	0.5	2.00	1.22	6.15	8.80	2.50
1.00 to 1.99	1	3.00	1.54	3.96	8.86	2.50
2.00 to 2.99	2	5.80	2.80	4.29	7.74	2.50
3.00 to 4.99	3	7.90	3.57	3.15	20.81	1.17
5.00 to 7.49	5	12.6	4.78	3.34	23.57	1.50
7.50 to 9.99	7.5	18.6	6.23	2.65	28.91	1.17
10.00 to 14.99	10	25.3	8.75	2.43	30.78	1.17
15.00 to 19.99	15	37.3	12.7	2.07	29.13	1.00
20.00 to 24.99	20	49.1	9.20	2.09	29.53	1.00
25.00 to 29.99	25	60.0	16.7	1.75	31.49	1.00
30.00 to 39.99	30	72.4	19.8	1.90	32.55	1.00

460 V

Motor capacity (HP)	Nominal applied motor (HP)	Rated current (A)	No-load current (A)	%R (%)	%X (%)	Rated slip frequency (Hz)
P02/A16		P03/A17	P06/A20	P07/A21	P08/A22	P12/A26
0.01 to 0.11	1.10	0.22	0.20	13.79	11.75	2.50
0.12 to 0.24	0.12	0.34	0.27	12.96	12.67	2.50
0.25 to 0.49	0.25	0.70	0.56	11.02	13.84	2.50
0.50 to 0.99	0.5	1.00	0.61	6.15	8.80	2.50
1.00 to 1.99	1	1.50	0.77	3.96	8.86	2.50
2.00 to 2.99	2	2.90	1.40	4.29	7.74	2.50
3.00 to 4.99	3	4.00	1.79	3.15	20.81	1.17
5.00 to 7.49	5	6.30	2.39	3.34	23.57	1.50
7.50 to 9.99	7.5	9.30	3.12	2.65	28.91	1.17
10.00 to 14.99	10	12.7	4.37	2.43	30.78	1.17
15.00 to 19.99	15	18.7	6.36	2.07	29.13	1.00
20.00 to 24.99	20	24.6	4.60	2.09	29.53	1.00
25.00 to 29.99	25	30.0	8.33	1.75	31.49	1.00
30.00 to 39.99	30	36.2	9.88	1.90	32.55	1.00

H04	Auto-reset (Times)
------------	---------------------------

H05	Auto-reset (Reset interval)
------------	------------------------------------

H04 and H05 specify the auto-reset function that makes the inverter automatically attempt to reset the tripped state and restart without issuing an alarm (for any faults) even if any protective function subject to reset is activated and the inverter enters the forced-to-stop state (tripped state).

If the protective function works in excess of the times specified by H04, the inverter will issue an alarm (for any faults) and not attempt to auto-reset the tripped state.

Listed below are the recoverable alarm statuses to be retried.

Alarm status	LED monitor displays:	Alarm status	LED monitor displays:
Overcurrent protection	<i>OL 1, OL2 or OL3</i>	Motor overheated	<i>OH4</i>
Overvoltage protection	<i>OU 1, OU2 or OU3</i>	Motor overloaded	<i>OL 1 or OL2</i>
Heat sink overheated	<i>OH 1</i>	Inverter overloaded	<i>OLU</i>

■ Number of reset times (H04)

H04 specifies the number of reset times for automatically escaping the tripped state. When H04 = 0, the auto-reset function will not be activated.

⚠ WARNING
<p>If the "auto-reset" function has been specified, the inverter may automatically restart and run the motor stopped due to a trip fault, depending on the cause of the tripping.</p> <p>Design the machinery so that human body and peripheral equipment safety is ensured even when the auto-resetting succeeds.</p> <p>Otherwise an accident could occur.</p>

■ Reset interval (H05)

After the reset interval specified by H05 from when the inverter enters the tripped state, it issues a reset command to auto-reset the tripped state. Refer to the timing scheme diagrams below.

<Operation timing scheme>

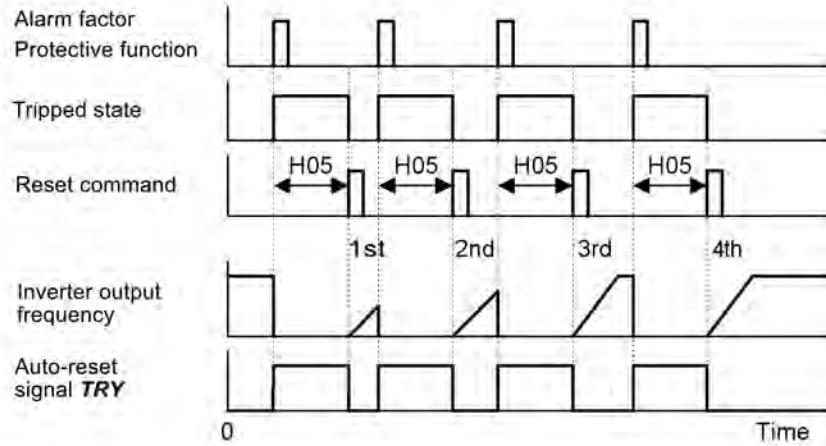

<Timing scheme for failed retry (No. of reset times: 3)>

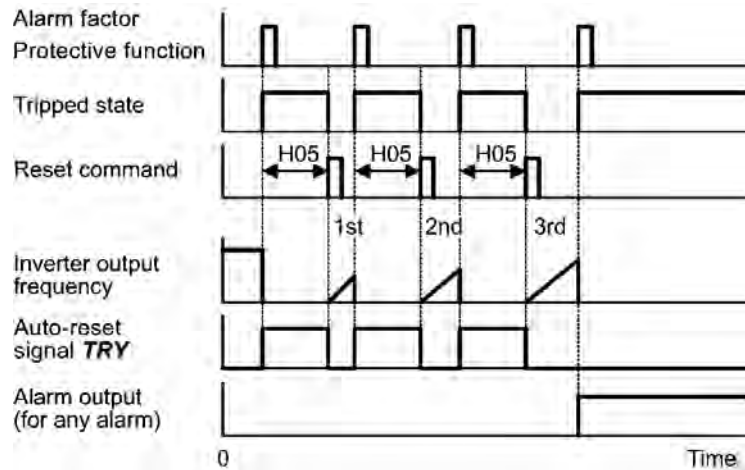

- The reset operation state can be monitored by external equipment via the inverter's digital output terminal [Y1], [Y2], or [30A/B/C] to which the *TRY* is assigned by setting "26" with function code E20, E21, or E27.

H06

Cooling Fan ON/OFF Control

To prolong the life of the cooling fan and reduce fan noise during running, the cooling fan stops when the temperature inside the inverter drops below a certain level while the inverter stops. However, since frequent switching of the cooling fan shortens its life, the cooling fan is kept running for 10 minutes once it is started.

H06 specifies whether to keep running the cooling fan all the time or to control its ON/OFF.

Data for H06	Cooling fan ON/OFF
0	Disable (Always in operation)
1	Enable (ON/OFF controllable)

H07**Acceleration/Deceleration Pattern**

H07 specifies the acceleration and deceleration patterns (patterns to control output frequency).

Data for H07	Accl./Decel. pattern
0	Linear (Default)
1	S-curve (Weak)
2	S-curve (Strong)
3	Curvilinear

Linear acceleration/deceleration

The inverter runs the motor with the constant acceleration and deceleration.

S-curve acceleration/deceleration

To reduce an impact that acceleration/deceleration would make on the machine, the inverter gradually accelerates/decelerates the motor in both the acceleration/deceleration starting and ending zones. Two types of S-curve acceleration/deceleration are available; 5% (weak) and 10% (strong) of the maximum frequency, which are shared by the four inflection points.

The acceleration/deceleration time command determines the duration of acceleration/deceleration in the linear period; hence, the actual acceleration/deceleration time is longer than the reference acceleration/deceleration time.

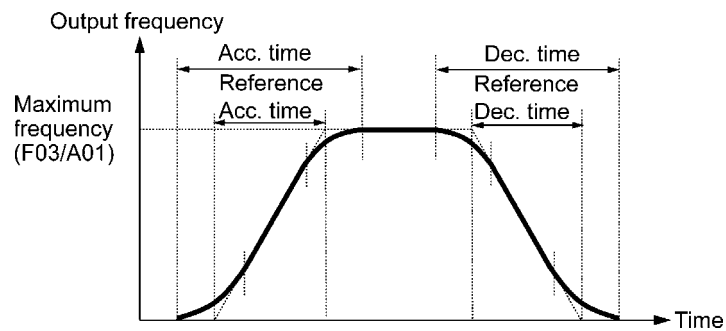
Acceleration/deceleration time

<S-curve acceleration/deceleration (weak): when the frequency change is 10% or more of the maximum frequency>

$$\begin{aligned} \text{Acceleration or deceleration time (s): } & (2 \times 5/100 + 90/100 + 2 \times 5/100) \times (\text{reference} \\ & \text{acceleration or deceleration time}) \\ & = 1.1 \times (\text{reference acceleration or deceleration time}) \end{aligned}$$

<S-curve acceleration/deceleration (strong): when the frequency change is 20% or more of the maximum frequency>

$$\begin{aligned} \text{Acceleration or deceleration time (s): } & (2 \times 10/100 + 80/100 + 2 \times 10/100) \times (\text{reference} \\ & \text{acceleration or deceleration time}) \\ & = 1.2 \times (\text{reference acceleration or deceleration time}) \end{aligned}$$

Curvilinear acceleration/deceleration

Acceleration/deceleration is linear below the base frequency (constant torque) but it slows down above the base frequency to maintain a certain level of load factor (constant output).

This acceleration/deceleration pattern allows the motor to accelerate or decelerate with the maximum performance of the motor.

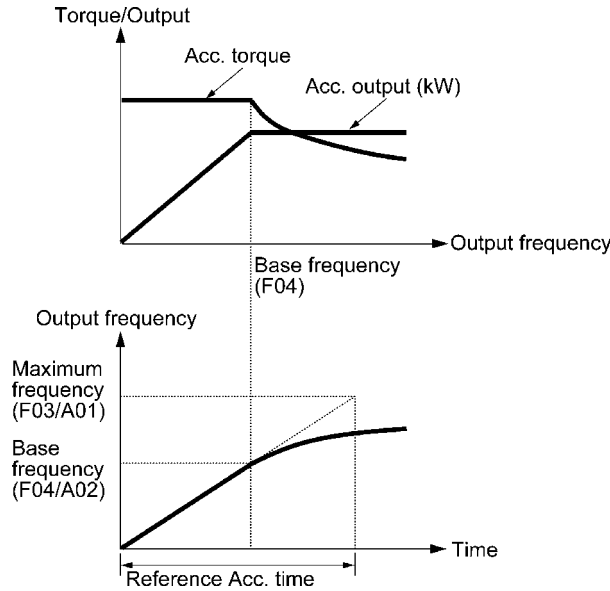

The figures at left show the acceleration characteristics. Similar characteristics apply to the deceleration.



Choose an appropriate acceleration/deceleration time, taking into account the machinery's load torque.

H08

Rotational Direction Limitation

H08 inhibits the motor from running in an unexpected rotational direction due to miss-operation of run commands, miss-polarization of frequency commands, or other mistakes.

Data for H08	Function
0	Disable
1	Enable (Reverse rotation inhibited)
2	Enable (Forward rotation inhibited)

H09

Starting Mode (Auto search)

H49 (Starting Mode, Delay time)

H09 specifies the auto search mode for idling motor speed to run the idling motor without stopping it.

The auto search applies to both a restart of the inverter after a momentary power failure and every normal startup.

The auto search mode can be switched by assigning an *STM* terminal command ("Enable auto search for idling motor speed at starting") to a digital input terminal with any of E01 to E05 (function code data = 26). If no *STM* is assigned, the inverter interprets *STM* as being OFF by default.

Auto search for idling motor speed

Starting the inverter (with a run command ON, *BX* OFF, auto-reset, etc.) with *STM* being ON searches for the idling motor speed for a maximum of 1.2 seconds to run the idling motor without stopping it. After completion of the auto search, the inverter accelerates the motor up to the reference frequency according to the frequency command and the preset acceleration time.

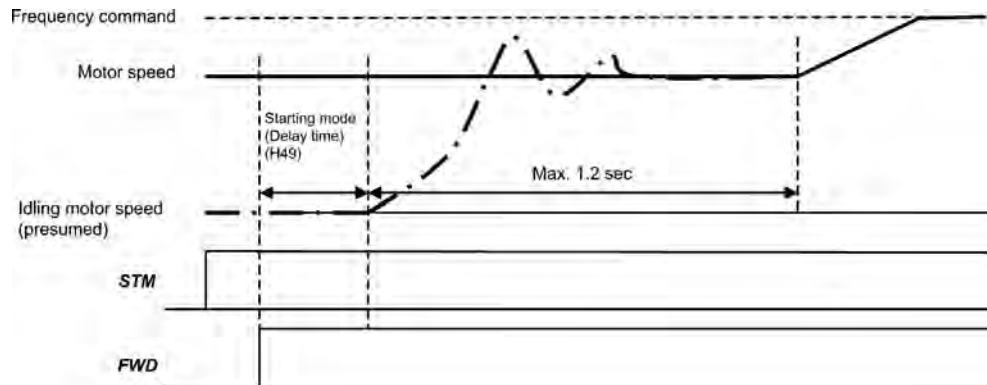

Auto search for idling motor speed to follow

- H09 and *STM* terminal command ("Enable auto search for idling motor speed at starting")

The combination of H09 data and the *STM* state determines whether to perform the auto search as listed below.

Data for H09	<i>STM</i>	Auto search for idling motor speed at starting	
		For restart after momentary power failure (F14 = 4 or 5)	For normal startup
0: Disable	OFF	Disable	Disable
1: Enable	OFF	Enable	Disable
2: Enable	OFF	Enable	Enable
--	ON	Enable	Enable

■ Auto search delay time (H49)

Auto search for the idling motor speed will become unsuccessful if it is done while the motor retains residual voltage. It is, therefore, necessary to leave the motor for an enough time for residual voltage to disappear. H49 specifies that time (0.0 to 10.0 sec.).

At the startup triggered by a run command ON, auto search starts with the delay specified by H49. When two inverters share a single motor to drive it alternately, coast to stop it, and perform auto search every switching, H49 can eliminate the need of the run command timing control.

The H49 data should be the same value as the H13 data (Restart Mode after Momentary Power Failure, Restart time). At the restart after a momentary power failure, at the start by turning the terminal command **BX** ("Coast to a stop") OFF and ON, or at the restart by auto-reset, the inverter applies the delay time specified by H13. The inverter will not start unless the time specified by H13 has elapsed, even if the starting conditions are satisfied.

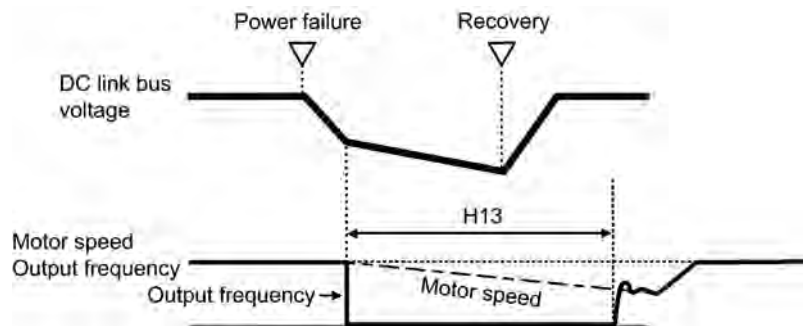

- Note**
- Be sure to auto-tune the inverter preceding the start of auto search for the idling motor speed.
 - When the estimated speed exceeds the maximum frequency or the upper limit frequency, the inverter disables auto search and starts in normal mode.
 - In auto search with the restart after momentary power failure enabled (F14 = 4 or 5) and the allowable momentary power failure time specified (H16), turning a run command ON will start auto search even if the time specified by H16 has elapsed.
 - During auto search, if an overcurrent or overvoltage trip occurs, the inverter restarts the suspended auto search.
 - Perform auto search at 60 Hz or below.
 - Note that auto search may not fully provide the expected/designed performance depending on conditions including the load, motor parameters, power cable length, and other externally determined events.
 - When the inverter is equipped with any of output circuit filters OFL-□□□-2 and -4 in the secondary lines, it cannot perform auto search. Use the filter OFL-□□□-□A instead.

H11**Deceleration Mode**

H11 specifies the deceleration mode to be applied when a run command is turned OFF.

Data for H11	Function
0	Normal deceleration The inverter decelerates and stops the motor according to deceleration commands specified by H07 (Acceleration/deceleration pattern), F08 (Deceleration time 1), and E11 (Deceleration time 2).
1	Coast-to-stop The inverter immediately shuts down its output, so the motor stops according to the inertia of the motor and machine and their kinetic energy losses.



When reducing the reference frequency, the inverter decelerates the motor according to the deceleration commands even if H11 = 1 (Coast-to-stop).

H12**Instantaneous Overcurrent Limiting (Mode selection)**

H12 specifies whether the inverter invokes the current limit processing or enters the overcurrent trip when its output current exceeds the instantaneous overcurrent limiting level. Under the current limit processing, the inverter immediately turns off its output gate to suppress the further current increase and continues to control the output frequency.

Data for H12	Function
0	Disable An overcurrent trip occurs at the instantaneous overcurrent limiting level.
1	Enable The current limiting operation is effective.

If any problem occurs when the motor torque temporarily drops during current limiting processing, it is necessary to cause an overcurrent trip (H12 = 0) and actuate a mechanical brake at the same time.



The similar function is the current limiter specified by F43 and F44. The current limiter (F43/F44) implements the current control by software, so an operation delay occurs. When you have enabled the current limiter (F43/F44), also enable the instantaneous overcurrent limiting with H12 to obtain a quick response current limiting.

Depending on the load, extremely short acceleration time may activate the current limiting to suppress the increase of the inverter output frequency, causing the system oscillation (hunting) or activating the inverter overvoltage trip (alarm \overline{LIL}). When specifying the acceleration time, therefore, you need to take into account machinery characteristics and moment of inertia of the load.

H13	Restart Mode after Momentary Power Failure (Restart time) F14 (Restart Mode after Momentary Power Failure, Mode selection)
H14	Restart Mode after Momentary Power Failure (Frequency fall rate) F14
H16	Restart Mode after Momentary Power Failure (Allowable momentary power failure time) F14

For configuring these function codes (restart time, frequency fall rate and allowable momentary power failure time), refer to the description of F14.

H26	Thermistor (Mode selection)
H27	Thermistor (Level)

These function codes specify the PTC (Positive Temperature Coefficient) thermistor embedded in the motor. The thermistor is used to protect the motor from overheating or output an alarm signal.

■ Thermistor (Mode selection) (H26)

H26 selects the operation mode (protection or alarm) for the PTC thermistor as listed below.

Data for H26	Action
0	Disable
1	Enable When the voltage sensed by the PTC thermistor exceeds the detection level, the motor protective function (alarm \overline{UL}) is triggered, causing the inverter to enter an alarm stop state.

■ Thermistor (Level) (H27)

H27 specifies the detection level (expressed in voltage) for the temperature sensed by the PTC thermistor.

- Data setting range: 0.00 to 5.00 (V)

The temperature at which the overheating protection becomes activated depends on the characteristics of the PTC thermistor. The internal resistance of the thermistor will significantly change at the alarm temperature. The detection level (voltage) is specified based on the change of the internal resistance.

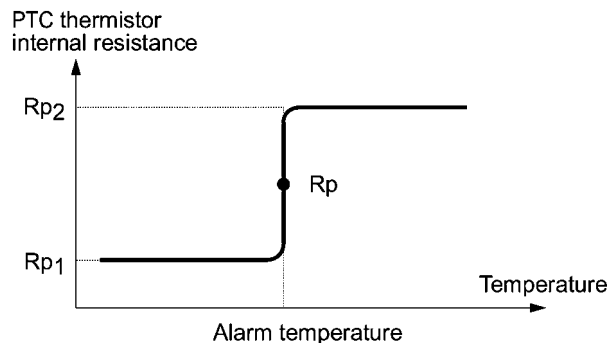

Suppose that the internal resistance of the PTC thermistor at the alarm temperature is R_p , the detection level (voltage) V_{v2} is calculated by the expression below. Set the result V_{v2} to function code H27.

$$V_{v2} = \frac{\frac{250 \times R_p}{250 + R_p}}{1000 + \frac{250 \times R_p}{250 + R_p}} \times 10 \text{ (V)}$$

Connect the PTC thermistor as shown below. The voltage obtained by dividing the input voltage with a set of internal resistors is compared with the detection level voltage specified by H27.

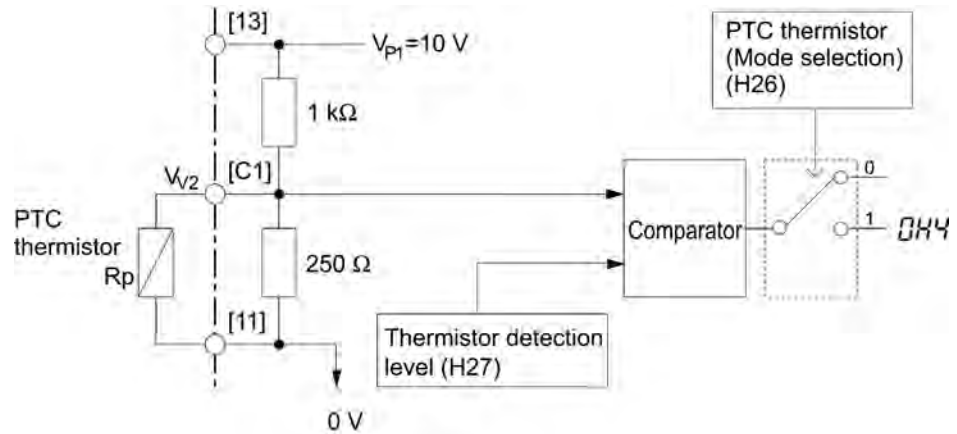

Note To use analog input terminal [C1] for the PTC thermistor input, turn switches SW7 and SW8 on the interface printed circuit board to the specified positions and set E59 data to "0" (C1 function). For details, refer to "Setting up the slide switches" on page 8-17.

H28

Droop Control

In a system in which two or more motors drive single machinery, any speed gap between inverter-driven motors results in some load unbalance between motors. The droop control allows each inverter to drive the motor with the speed droop characteristics for increasing its load, eliminating such kind of load unbalance.

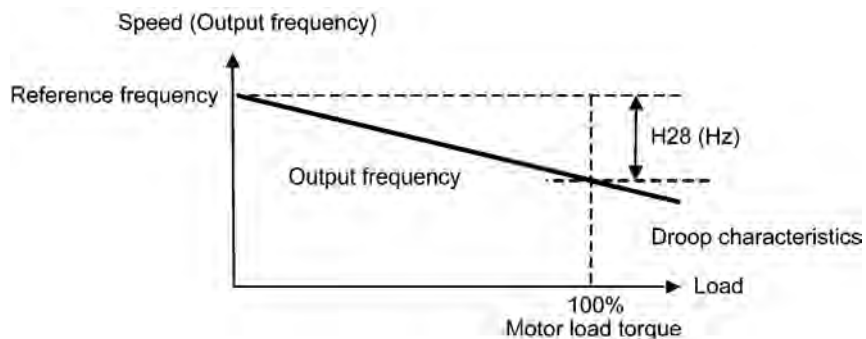

Note To use droop control, be sure to auto-tune the inverter for the motor.

H30	Communications Link Function (Mode selection) y98 (Bus Link Function, Mode selection)
------------	--

Using the RS-485 communications link (standard/option) or field bus (option) allows you to issue frequency commands and run commands from a computer or PLC at a remote location, as well as monitoring the inverter running information and the function code data.

H30 and y98 specify the sources of those commands--"inverter itself" and "computers or PLCs via the RS-485 communications link or field bus." H30 is for the RS-485 communications link; y98 for the field bus.

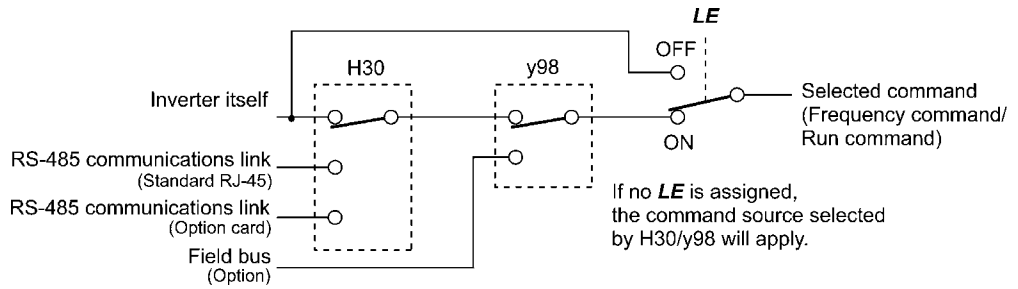

Command sources selectable

Command sources	Description
Inverter itself	Sources except RS-485 communications link and field bus Frequency command source: Specified by F01/C30, or multi-frequency command Run command source: Via the keypad or digital input terminals selected by F02
Via RS-485 communications link (standard)	Via the standard RJ-45 port used for connecting a keypad
Via RS-485 communications link (option card)	Via RS-485 communications link (option card)
Via field bus (option)	Via field bus (option) using FA protocol such as DeviceNet or PROFIBUS-DP

Command sources specified by H30 (Mode selection)

Data for H30	Frequency command	Run command
0	Inverter itself (F01/C30)	Inverter itself (F02)
1	Via RS-485 communications link (standard)	Inverter itself (F02)
2	Inverter itself (F01/C30)	Via RS-485 communications link (standard)
3	Via RS-485 communications link (standard)	Via RS-485 communications link (standard)
4	Via RS-485 communications link (option card)	Inverter itself (F02)
5	Via RS-485 communications link (option card)	Via RS-485 communications link (standard)
6	Inverter itself (F01/C30)	Via RS-485 communications link (option card)
7	Via RS-485 communications link (standard)	Via RS-485 communications link (option card)
8	Via RS-485 communications link (option card)	Via RS-485 communications link (option card)

Command sources specified by y98

Data for y98	Frequency command	Run command
0	Follow H30 data	Follow H30 data
1	Via field bus (option)	Follow H30 data
2	Follow H30 data	Via field bus (option)
3	Via field bus (option)	Via field bus (option)

Combination of command sources

		Frequency command			
		Inverter itself	Via RS-485 communications link (standard)	Via RS-485 communications link (option card)	Via field bus (option)
Run command source	Inverter itself	H30 = 0 y98 = 0	H30 = 1 y98 = 0	H30=4 y98=0	H30=0 (1 or 4) y98=1
	Via RS-485 communications link (standard)	H30 = 2 y98 = 0	H30 = 3 y98 = 0	H30=5 y98=0	H30=2 (3 or 5) y98=1
	Via RS-485 communications link (option card)	H30 = 6 y98 = 0	H30 = 7 y98 = 0	H30=8 y98=0	H30=6 (7 or 8) y98=1
	Via field bus (option)	H30 = 0 (2 or 6) y98 = 2	H30 = 1 (3 or 7) y98 = 2	H30 = 4 (5 or 8) y98 = 2	H30 = 0 (1 to 8) y98 = 3

 For details, refer to Chapter 4 "BLOCK DIAGRAMS FOR CONTROL LOGIC" and the RS-485 Communication User's Manual or the Field Bus Option Instruction Manual.

- When an **LE** terminal command ("Enable communications link via RS-485 or field bus") is assigned to a digital input terminal, turning **LE** ON makes the settings of H30 and y98 effective. When **LE** is OFF, those settings are ineffective so that both frequency commands and run commands specified from the inverter itself take control.

H42

Capacitance of DC Link Bus Capacitor

H42 displays the measured capacitance of the DC link bus capacitor.

H43

Cumulative Run Time of Cooling Fan

H43 displays the cumulative run time of the cooling fan.

H44

Startup Times of Motor 1

A46 (Startup Times of Motor 2)

H44 displays the startup times of motor 1.

H45	Mock Alarm	H97 (Clear Alarm Data)
------------	-------------------	-------------------------------

H45 causes the inverter to generate a mock alarm in order to check whether external sequences function correctly at the time of machine setup.

Setting the H45 data to "1" displays mock alarm $\overline{E}rrr$ on the LED monitor and issues alarm output *ALM* to the digital output terminal specified (see E20, E21 and E27). (Accessing the H45 data requires simultaneous keying of "STOP key + \curvearrowright key.") After that, the H45 data automatically reverts to "0," allowing you to reset the alarm.

Just as for data (alarm history and relevant information) of those alarms that could occur in running of the inverter, the inverter saves mock alarm data, enabling you to confirm the mock alarm status.

To clear the mock alarm data, use H97. (Accessing the H97 data requires simultaneous keying of "STOP key + \curvearrowright key.") For details, refer to the description of H97.

H47	Initial Capacitance of DC Link Bus Capacitor
------------	---

H47 displays the initial value of the capacitance of the DC link bus capacitor.

H48	Cumulative Run Time of Capacitors on Printed Circuit Boards
------------	--

H48 displays the cumulative run time of the capacitors mounted on the printed circuit boards.

H49	Starting Mode (Delay time)	H09 (Starting Mode, Auto search)
------------	-----------------------------------	---

For details about the auto search delay time, refer to the description of H09.

H50	Non-linear V/f Pattern 1 (Frequency)	F04 (Base Frequency 1) F05 (Rated Voltage at Base Frequency 1) F06 (Maximum Output Voltage 1)
------------	---	--

H51	Non-linear V/f Pattern 1 (Voltage)	F04 to F06
------------	---	-------------------

H52	Non-linear V/f Pattern 2 (Frequency)	F04 to F06
------------	---	-------------------

H53	Non-linear V/f Pattern 2 (Voltage)	F04 to F06
------------	---	-------------------

For details about the setting of the non-linear V/f pattern, refer to the descriptions of F04 to F06.

H54	ACC/DEC Time (Jogging operation)
------------	---

H54 specifies the common acceleration and deceleration time for jogging operation.

- Data setting range: 0.00 to 3600 (s)

 For details about the jogging operation (*JOG*), refer to E01 to E05 that assign terminal commands to digital input terminals [X1] to [X5].

H56**Deceleration Time for Forced Stop**

Assigning the "Force to stop" command **STOP** to a digital input terminal (data = 30) and turning it ON decelerates the inverter output to stop in accordance with the H56 data. When the output has stopped, the inverter enters an alarm stop state with alarm \overline{Er} displayed.

H61**UP/DOWN Control (Initial frequency setting)**

H61 specifies the initial reference frequency to be applied at startup of **UP/DOWN** control that increases or decreases the reference frequency with the **UP/DOWN** terminal command.



For details, refer to function codes E01 to E05 that assign terminal commands to digital input terminals [X1] to [X5].

H63**Low Limiter (Mode selection)**

F15 (Frequency Limiter, High)
F16 (Frequency Limiter, Low)

For how to set up this function code data, refer to the descriptions of F15 and F16.

H64**Low Limiter (Lower limiting frequency)**

H64 specifies the lower limit of frequency to be applied when the current limiter, torque limiter, automatic deceleration (anti-regenerative control), or overload prevention control is activated. Normally, it is not necessary to change the lower limit of frequency.

- Data setting range: 0.0 to 60.0 (Hz)

H68**Slip Compensation 1 (Operating conditions)**

F42 (Control Mode Selection 1)
A40 (Slip Compensation 2, Operating conditions)

For details about the setting of slip compensation 1, refer to the description of F42.

H69**Automatic Deceleration (Anti-regenerative control) (Mode selection)****H76 (Torque Limiter, Frequency increment limit for braking)**

H69 enables or disables the anti-regenerative control.

In the inverter not equipped with a PWM converter or brake unit, if regenerative energy returned exceeds the inverter's braking capability, an overvoltage trip occurs.

To avoid such an overvoltage trip, enable the anti-regenerative control with this function code, and the inverter controls the output frequency to keep the braking torque around 0 Nm in both the acceleration/deceleration and constant speed running phases.

Since increasing the output frequency too much in the anti-regenerative control is dangerous, the inverter has a torque limiter (Frequency increment limit for braking) that can be specified by H76. The torque limiter limits the inverter's output frequency to less than "Reference frequency + H76 setting."

Note that the torque limiter activated restrains the anti-regenerative control, resulting in a trip with an overvoltage alarm in some cases. Increasing the H76 data (0.0 to 400.0 Hz) makes the anti-regenerative control capability high.

In addition, during deceleration triggered by turning the run command OFF, the anti-regenerative control increases the output frequency so that the inverter may not stop the load depending on the load state (huge moment of inertia, for example). To avoid that, H69 provides a choice of cancellation of the anti-regenerative control to apply when three times the specified deceleration time is elapsed, thus decelerating the motor.

Data for H69	Function
0	Disable
2	Enable (Canceled if actual deceleration time exceeds three times the one specified by F08/E11)
4	Enable (Not canceled even if actual deceleration time exceeds three times the one specified by F08/E11.)



Enabling the anti-regenerative control may automatically increase the deceleration time.

When a brake unit is connected, disable the anti-regenerative control.

H70**Overload Prevention Control**

H70 specifies the decelerating rate of the output frequency to prevent a trip from occurring due to an overload. This control decreases the output frequency of the inverter before the inverter trips due to a heat sink overheat or inverter overload (with an alarm indication of \overline{OH} / or \overline{OL} /, respectively). It is useful for equipment such as pumps where a decrease in the output frequency leads to a decrease in the load and it is necessary to keep the motor running even when the output frequency drops.

Data for H70	Function
0.00	Decelerate the motor by deceleration time 1 (F08) or 2 (E11)
0.01 to 100.0	Decelerate the motor by deceleration rate from 0.01 to 100.0 (Hz/s)
999	Disable overload prevention control



In equipment where a decrease in the output frequency does not lead to a decrease in the load, the overload prevention control is of no use and should not be enabled.

H71	Deceleration Characteristics
------------	-------------------------------------

Setting the H71 data to "1" (ON) enables forced brake control. If regenerative energy produced during the deceleration of the motor and returned to the inverter exceeds the inverter's braking capability, an overvoltage trip will occur. The forced brake control increases the motor energy loss during deceleration, increasing the deceleration torque.

 This function is aimed at controlling the torque during deceleration; it has no effect if there is braking load.
Enabling the automatic deceleration (anti-regenerative control, H69 = 2 or 4) disables the deceleration characteristics specified by H71.

H76	Torque Limiter (Frequency increment limit for braking) H69 (Automatic Deceleration, Mode selection)
------------	--

For details about the function of H76, refer to the description of H69.

H80	Output Current Fluctuation Damping Gain for Motor 1 A41 (Output Current Fluctuation Damping Gain for Motor 2)
------------	--

The inverter output current driving the motor may fluctuate due to the motor characteristics and/or backlash in the machine. Modifying the H80 data adjusts the controls in order to suppress such fluctuation. However, as incorrect setting of this gain may cause larger current fluctuation, do not modify the default setting unless it is necessary.

- Data setting range: 0.00 to 0.40

H89	Reserved*
------------	------------------

H90	Reserved*
------------	------------------

H91	Reserved*
------------	------------------

* These are reserved for particular manufacturers. Do not access them.

H94	Cumulative Motor Run Time 1 A45 (Cumulative Motor Run Time 2)
------------	--

Operating the keypad can display the cumulative run time of motor 1. This feature is useful for management and maintenance of the mechanical system. H94 allows you to set the cumulative run time of the motor to the desired value. For example, specifying "0" clears the cumulative run time of the motor.

 The H94 data is in hexadecimal notation. It appears in decimal notation on the keypad.

H95	DC Braking (Braking response mode) F20 to F22 (DC Braking 1, Braking starting frequency, Braking level, and Braking time) A09 to A11 (DC Braking 2, Braking starting frequency, Braking level, and Braking time)
------------	---

For setting of DC braking, refer to the descriptions of F20 to F22.

H96**STOP Key Priority/Start Check Function**

H96 specifies a functional combination of "STOP key priority" and "Start check function" as listed below.

Data for H96	STOP key priority	Start check function
0	Disable	Disable
1	Enable	Disable
2	Disable	Enable
3	Enable	Enable

■ **STOP key priority**

Even when run commands are entered from the digital input terminals or via the RS-485 communications link (link operation), pressing the  key forces the inverter to decelerate and stop the motor. After that, "E-r-E" appears on the LED monitor.



■ **Start check function**

For safety, this function checks whether any run command has been turned ON or not in each of the following situations. If it has been turned ON, the inverter does not start up with alarm code "E-r-E" displayed on the LED monitor.

- When the power to the inverter is turned ON.
- When the  key is pressed to release the alarm status or when the "Reset alarm" terminal command **RST** (digital input) is turned ON.
- When the run command source is switched by the "Enable communications link via RS-485 or field bus" terminal command **LE** (digital input).

H97**Clear Alarm Data****H45 (Mock Alarm)**

H97 clears all alarm data (alarm history and relevant information) of alarms that have occurred in running of the inverter and mock alarms that have been caused by H45 at the time of machine setup, both of which are saved in the inverter memory.

Setting the H97 data to "1" clears the saved alarm data. (Accessing the H97 data requires simultaneous keying of " key +  key.") After that, the H97 data automatically reverts to "0."

H98**Protection/Maintenance Function (Mode selection)**

H98 specifies whether to enable or disable (a) automatic lowering of carrier frequency, (b) input phase loss protection, (c) output phase loss protection, and (d) judgment on the life of the DC link bus capacitor, as well as specifying the judgment threshold on the life of the DC link bus capacitor, in a style of combination (Bit 0 to Bit 4).

Automatic lowering of carrier frequency (Bit 0)

This function should be used for important machinery that requires keeping the inverter running.

Even if a heat sink overheat or overload occurs due to excessive load, abnormal ambient temperature, or cooling system failure, enabling this function lowers the carrier frequency to avoid tripping (). Note that enabling this function results in increased motor noise.

Input phase loss protection (L₁) (Bit 1)

Upon detection of an excessive stress inflicted on the apparatus connected to the main circuit due to phase loss or line-to-line voltage unbalance in the three-phase power supplied to the inverter, this feature stops the inverter and displays an alarm L₁.

 In configurations where only a light load is driven or a DC reactor is connected, phase loss or line-to-line voltage unbalance may not be detected because of the relatively small stress on the apparatus connected to the main circuit.

Output phase loss protection (L₂) (Bit 2)

Upon detection of phase loss in the output while the inverter is running, this feature stops the inverter and displays an alarm L₂. Where a magnetic contactor is installed in the inverter output circuit, if the magnetic contactor goes OFF during operation, all the phases will be lost. In such a case, this protection feature does not work.

Judgment threshold on the life of DC link bus capacitor (Bit 3)

Bit 3 is used to select the threshold for judging the life of the DC link bus capacitor between factory default setting and your own choice.

 Before specifying the threshold of your own choice, measure and confirm the reference level in advance.

Judgment on the life of DC link bus capacitor (Bit 4)

Whether the DC link bus capacitor has reached its life is determined by measuring the length of time for discharging after power off. The discharging time is determined by the capacitance of the DC link bus capacitor and the load inside the inverter. Therefore, if the load inside the inverter fluctuates significantly, the discharging time cannot be accurately measured, and as a result, it may be mistakenly determined that the life has been reached. To avoid such an error, you can disable the judgment on the life of the DC link bus capacitor.

Since load may vary significantly in the following cases, disable the judgment on the life during operation. Either conduct the measurement with the judgment enabled under appropriate conditions during periodical maintenance or conduct the measurement under the operating conditions matching the actual ones.

- An option card or multi-function keypad is used.
- Another inverter or equipment such as a PWM converter is connected to the terminals of the DC link bus.

To set data of H98, assign functions to each bit (total 5 bits) and set it in decimal format. The table below lists functions assigned to each bit.

Bit number	Bit 4	Bit 3	Bit 2	Bit 1	Bit 0
Function	Judge the life of DC link bus capacitor	Select life judgment threshold of DC link bus capacitor	Detect output phase loss	Detect input phase loss	Lower the carrier frequency automatically
Data = 0	Disable	Use the factory default	Disable	Disable	Disable
Data = 1	Enable	Use the user setting	Enable	Enable	Enable
Example of decimal expression (19)	Enable (1)	Use the factory default (0)	Disable (0)	Enable (1)	Enable (1)

Conversion table (Decimal to/from binary)

Decimal	Binary					Decimal	Binary				
	Bit 4	Bit 3	Bit 2	Bit 1	Bit 0		Bit 4	Bit 3	Bit 2	Bit 1	Bit 0
0	0	0	0	0	0	16	1	0	0	0	0
1	0	0	0	0	1	17	1	0	0	0	1
2	0	0	0	1	0	18	1	0	0	1	0
3	0	0	0	1	1	19	1	0	0	1	1
4	0	0	1	0	0	20	1	0	1	0	0
5	0	0	1	0	1	21	1	0	1	0	1
6	0	0	1	1	0	22	1	0	1	1	0
7	0	0	1	1	1	23	1	0	1	1	1
8	0	1	0	0	0	24	1	1	0	0	0
9	0	1	0	0	1	25	1	1	0	0	1
10	0	1	0	1	0	26	1	1	0	1	0
11	0	1	0	1	1	27	1	1	0	1	1
12	0	1	1	0	0	28	1	1	1	0	0
13	0	1	1	0	1	29	1	1	1	0	1
14	0	1	1	1	0	30	1	1	1	1	0
15	0	1	1	1	1	31	1	1	1	1	1

9.2.6 A codes (Motor 2 parameters)

A01	Maximum Frequency 2	F03 (Maximum Frequency 1)
A02	Base Frequency 2	F04 (Base Frequency 1)
A03	Rated Voltage at Base Frequency 2	F05 (Rated Voltage at Base Frequency 1)
A04	Maximum Output Voltage 2	F06 (Maximum Output Voltage 1)
A05	Torque Boost 2	F09 (Torque Boost 1)
A06	Electronic Thermal Overload Protection for Motor 2 (Select motor characteristics)	F10 (Electronic Thermal Overload Protection for Motor 1, Select motor characteristics)
A07	Electronic Thermal Overload Protection for Motor 2 (Overload detection level)	F11 (Electronic Thermal Overload Protection for Motor 1, Overload detection level)
A08	Electronic Thermal Overload Protection for Motor 2 (Thermal time constant)	F12 (Electronic Thermal Overload Protection for Motor 1, Thermal time constant)
A09	DC Braking 2 (Braking starting frequency)	F20 (DC Braking 1, Braking starting frequency)
A10	DC Braking 2 (Braking level)	F21 (DC Braking 1, Braking level)
A11	DC Braking 2 (Braking time)	F22 (DC Braking 1, Braking time)
A12	Starting Frequency 2	F23 (Starting Frequency 1)
A13	Load Selection/Auto Torque Boost/Auto Energy Saving Operation 2 F37 (Load Selection/Auto Torque Boost/Auto Energy Saving Operation 1)	
A14	Control Mode Selection 2	F42 (Control Mode Selection 1)
A15	Motor 2 (No. of poles)	P01 (Motor 1, No. of poles)
A16	Motor 2 (Rated capacity)	P02 (Motor 1, Rated capacity)
A17	Motor 2 (Rated current)	P03 (Motor 1, Rated current)
A18	Motor 2 (Auto-tuning)	P04 (Motor 1, Auto-tuning)
A19	Motor 2 (Online tuning)	P05 (Motor 1, Online tuning)
A20	Motor 2 (No-load current)	P06 (Motor 1, No-load current)
A21	Motor 2 (%R1)	P07 (Motor 1, %R1)
A22	Motor 2 (%X)	P08 (Motor 1, %X)

A23	Motor 2 (Slip compensation gain for driving) P09 (Motor 1, Slip compensation gain for driving)
A24	Motor 2 (Slip compensation response time) P10 (Motor 1, Slip compensation response time)
A25	Motor 2 (Slip compensation gain for braking) P11 (Motor 1, Slip compensation gain for braking)
A26	Motor 2 (Rated slip frequency) P12 (Motor 1, Rated slip frequency)
A39	Motor 2 Selection P99 (Motor 1 Selection)
A40	Slip Compensation 2 (Operating conditions) H68 (Slip Compensation 1, Operating conditions)
A41	Output Current Fluctuation Damping Gain for Motor 2 H80 (Output Current Fluctuation Damping Gain for Motor 1)
A45	Cumulative Motor Run Time 2 H94 (Cumulative Motor Run Time 1)
A46	Startup Times of Motor 2 H44 (Startup Times of Motor 1)

Function codes in this section apply to motor 2. For details about motor 1 and motor 2, refer to the descriptions of E1 to E05, "Select motor 2 / motor 1-- *M2/M1*."

9.2.7 J codes (Application functions)

J01	PID Control (Mode selection)
J02	PID Control (Remote command SV)
J03	PID Control P (Gain)
J04	PID Control I (Integral time)
J05	PID Control D (Differential time)
J06	PID Control (Feedback filter)

In PID control, the state of control object is detected by a sensor or similar device and is compared with the commanded value (e.g. temperature control command). If there is any deviation between them, the PID control operates so as to minimize it. Namely, it is a closed loop feedback system that matches controlled variable (feedback amount). PID control expands the application area of the inverter to process control such as flow control, pressure control, temperature control, and speed control such as dancer control.

If PID control is enabled (J01 = 1, 2 or 3), the frequency control of the inverter is switched from the drive frequency command generator block to the PID frequency command generator block.

PID process control block diagram

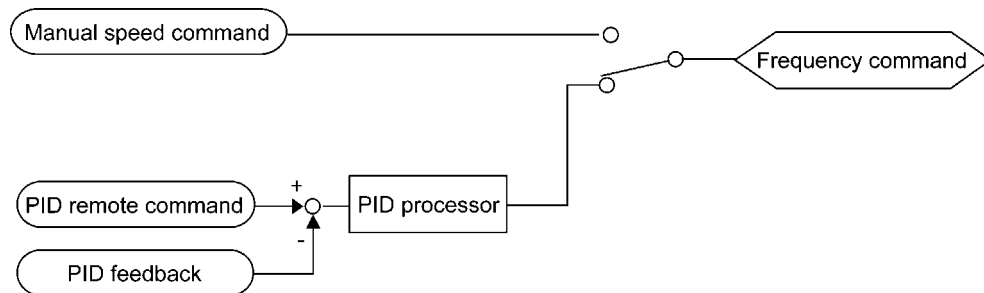

Dancer control block diagram

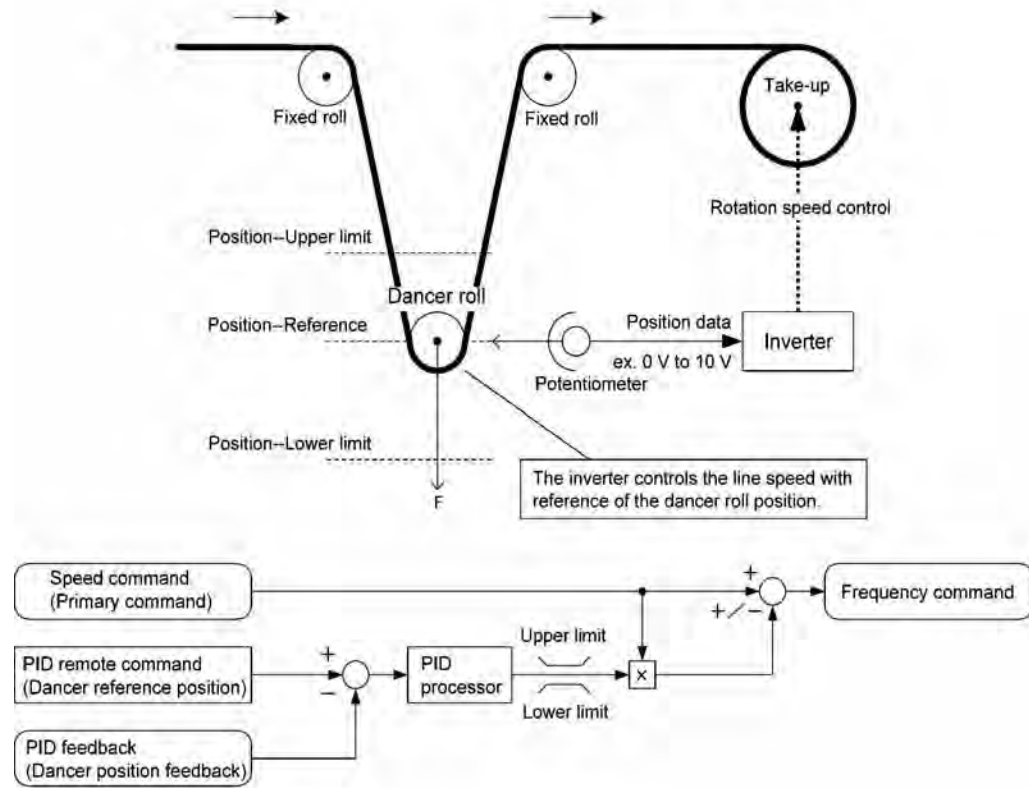

Refer to the block diagrams in Chapter 4, Section 4.5 "PID Process Control Block" and Section 4.6 "PID Dancer Control Block."

■ Mode Selection (J01)

J01 selects the PID control mode.

Data for J01	Function
0	Disable
1	Enable (Process control, normal operation)
2	Enable (Process control, inverse operation)
3	Enable (Dancer control)

- Using J01 enables switching between normal and inverse operations against the PID control output, so you can specify an increase/decrease of the motor rotating speed to the difference (error component) between the commanded (input) and feedback amounts, making it possible to apply the inverter to air conditioners. The *IVS* terminal command can also switch operation between normal and inverse.

For details of switching between normal and inverse operations, refer to the descriptions of E01 to E05.

Selecting Feedback Terminals

For feedback control, determine the connection terminal according to the type of the sensor output.

- If the sensor is a current output type, use the current input terminal [C1] of the inverter.
- If the sensor is a voltage output type, use the voltage input terminal [12] of the inverter, or switch over the terminal [C1] to the voltage input terminal and use it.

For details, refer to the descriptions of E61 through E63.

Application example: Process control

The operating range for PID process control is internally controlled as 0% through 100%. For the given feedback input, determine the operating range to be controlled by means of gain adjustment.

When the output level of the external sensor is within the range of 1 to 5 V:

- Use terminal [12] since the connection terminal is for voltage input.
- Example

Set the gain (C32 for analog input adjustment) at 200% in order to make the maximum value (5 V) of the external sensor's output correspond to 100%. Note that the input specification for terminal [12] is 0 to 10 V corresponding to 0 to 100%; thus, a gain factor of 200% (= 10 V ÷ 5 × 100) should be specified. Note also that any bias setting must not apply to feedback control.

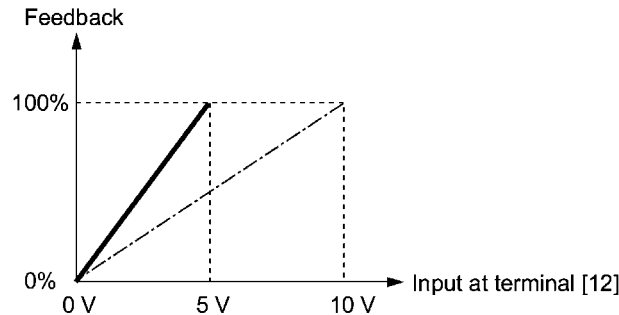

Application examples: Dancer control

Example 1. When the output level of the external sensor is ±7 VDC:

- Use terminal [12] since the voltage input is of bipolar.
- Example

When the external sensor's output is of bipolar, the inverter controls the speed within the range of ±100%. To convert the output ±7 VDC to ±100%, set the gain (C32 for analog input adjustment) at 143% as calculated below.

$$\frac{10 \text{ V}}{7 \text{ V}} \approx 143\%$$

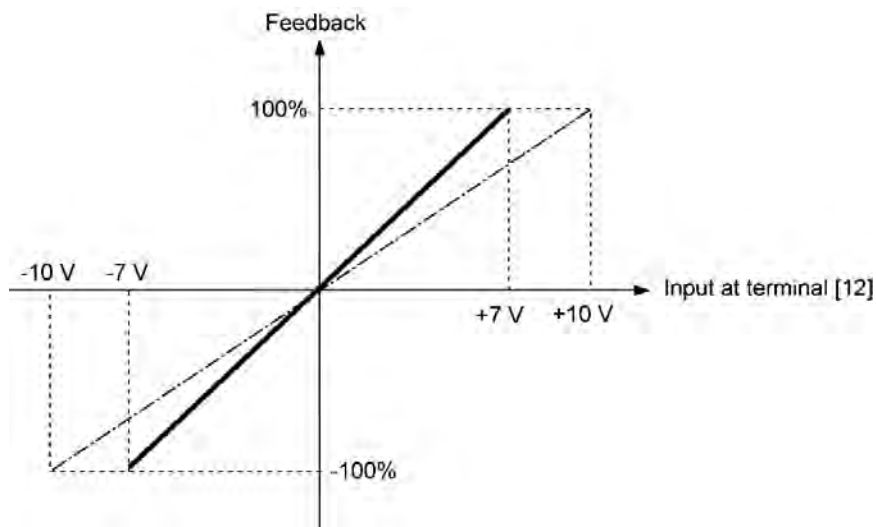

Example 2. When the output level of the external sensor is 0 to 10 VDC:

- Use terminal [12] or [C1] (V2 function) since the voltage input is of unipolar.
- Example

When the external sensor's output is of unipolar, the inverter controls the speed within the range of 0 to 100%.

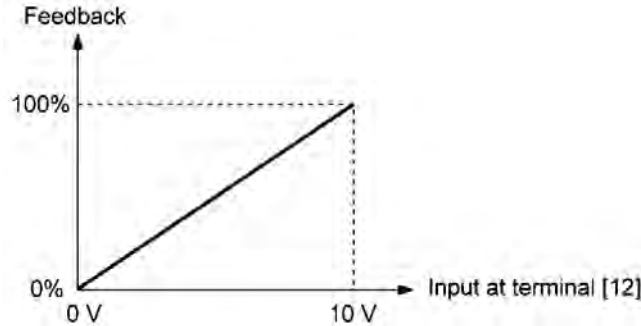

This example sets the dancer reference position around the + 5 V (50%) point.

■ Remote command **SV** (J02)

J02 sets the source that specifies the command value (**SV**) under PID control.

Data for J02	Function
0	Keypad Using the ⤴ / ⤵ keys on the keypad in conjunction with PID display coefficients (specified by E40 and E41), you can specify 0 to 100% of the PID command ($\pm 100\%$ for PID dancer control) in an easy-to-understand converted command format. For details of operation, refer to Chapter 3 "OPERATION USING THE KEYPAD."
1	PID command 1 (Terminals [12], [C1] (C1 function), [C1] (V2 function)) In addition to J02 setting, it is necessary to select PID command 1 for analog input (specified by any of E61 to E63, function code data = 3). For details, refer to the descriptions of E61 to E63.
3	Terminal command UP/DOWN Using the UP or DOWN command in conjunction with PID display coefficients (specified by E40 and E41), you can specify 0 to 100% of the PID command ($\pm 100\%$ for PID dancer control) in an easy-to-understand converted command format. In addition to J02 setting, it is necessary to assign UP and DOWN commands to any of terminals [X1] through [X5] with E01 through E05 (function code data = 17, 18). For details of UP/DOWN operation, refer to the assignment of the UP and DOWN commands.
4	Command via communications link Use function code S13 that specifies the communications-linked PID command. The transmission data of 20000 (decimal) is equal to 100% (maximum frequency) of the PID command. For details of the communications format, refer to the RS-485 Communication User's Manual (MEH448b).



- Other than the remote command selection by J02, the multi-frequency (C08 = 4) specified by **SS4** and **SS8** terminal commands can also be selected as a preset value for the PID command.

Calculate the setting data of the PID command using the expression below.

$$\text{PID command data (\%)} = (\text{Preset multi-frequency}) \div (\text{Maximum frequency}) \times 100$$

- In dancer control (J01 = 3), the setting from the keypad interlocks with data of J57 (PID control: Dancer reference position), and is saved as function code data.

Data Setting Range of PID Command (Only applicable to an analog input)

To select an analog input as a PID command, define the setting range of the PID command. As with frequency setting, you can arbitrary map the relationship between the command and the analog input value by adjusting the gain and bias.

📖 For details, refer to the descriptions of C32, C34, C37, C39, C42, C44, C51, and C52.

(Example) Mapping the range of 1 through 5 V at terminal [12] to 0 through 100%

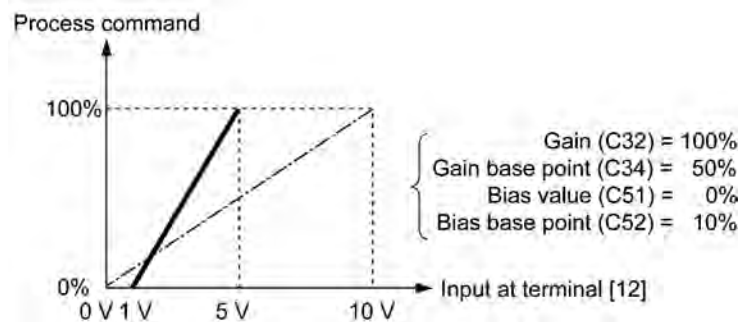

PID display coefficient and monitoring

To monitor PID commands and feedback amounts, define the display factor for converting them to numeric control values such as temperature for display.

📖 Refer to the descriptions of E40 and E41 for details on display coefficients, and to E43 for details on monitoring.

■ Gain (J03)

J03 specifies the gain for the PID processor.

- Data setting range: 0.000 to 30.000 (multiple)

P (Proportional) action

An operation in which an MV (manipulated value: output frequency) is proportional to the deviation is called P action, which outputs a manipulated value in proportion to deviation. However, the manipulated variable alone cannot eliminate deviation.

Gain is data that determines the system response level against the deviation in P action. An increase in gain speeds up response, but an excessive gain may oscillate the inverter output. A decrease in gain delays response, but it stabilizes the inverter output.

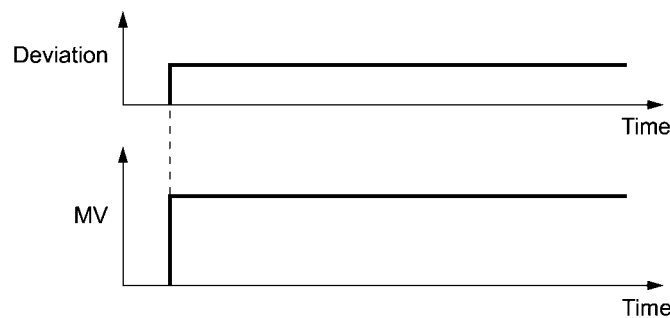

■ Integral time (J04)

J04 specifies the integral time for the PID processor.

- Data setting range: 0.0 to 3600.0 (s)
0.0 means that the integral component is ineffective.

I (Integral) action

An operation that the change rate of an MV (manipulated value: output frequency) is proportional to the integral value of deviation is called I action, which outputs the manipulated value that integrates the deviation. Therefore, I action is effective in bringing the feedback amount close to the commanded value. For the system whose deviation rapidly changes, however, this action cannot make it react quickly.

The effectiveness of I action is expressed by integral time as parameter, that is J04 data. The longer the integral time, the slower the response. The reaction to the external disturbance also becomes slow. The shorter the integral time, the faster the response. Setting too short integral time, however, makes the inverter output tend to oscillate against the external disturbance.

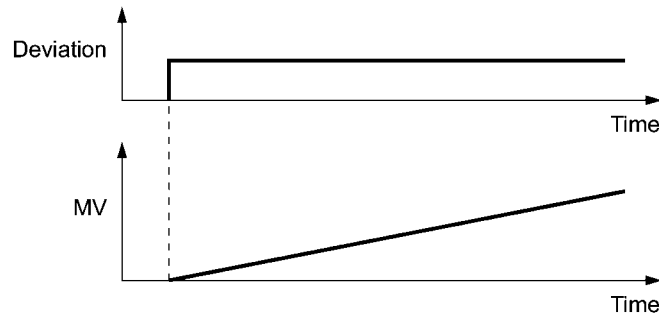

■ Differential time (J05)

J05 specifies the differential time for the PID processor.

- Data setting range: 0.00 to 600.00 (s)
0.00 means that the differential component is ineffective.

D (Differential) action

An operation that the MV (manipulated value: output frequency) is proportional to the differential value of the deviation is called D action, that outputs the manipulated value that differentiates the deviation. D action makes the inverter quickly react to a rapid change of deviation.

The effectiveness of D action is expressed by differential time as parameter, that is J05 data. Setting a long differential time will quickly suppress oscillation caused by P action when a deviation occurs. Too long differential time makes the inverter output oscillation more. Setting short differential time will weaken the suppression effect when the deviation occurs.

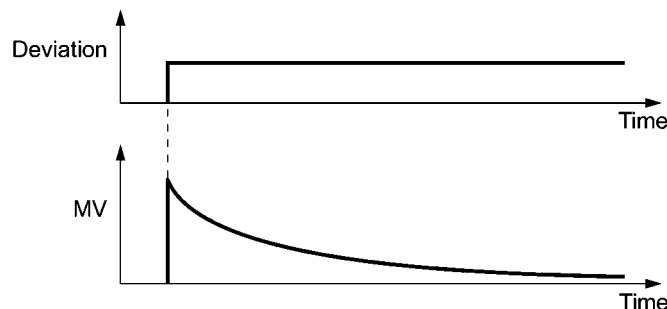

The combined use of P, I, and D actions are described below.

(1) PI control

PI control, which is a combination of P and I actions, is generally used to minimize the remaining deviation caused by P action. PI control acts to always minimize the deviation even if a commanded value changes or external disturbance steadily occurs. However, the longer the integral time, the slower the system response to quick-changed control.

P action can be used alone for loads with very large part of integral components.

(2) PD control

In PD control, the moment that a deviation occurs, the control rapidly generates much manipulated value than that generated by D action alone, to suppress the deviation increase. When the deviation becomes small, the behavior of P action becomes small.

A load including the integral component in the controlled system may oscillate due to the action of the integral component if P action alone is applied. In such a case, use PD control to reduce the oscillation caused by P action, for keeping the system stable. That is, PD control is applied to a system that does not contain any damping actions in its process.

(3) PID control

PID control is implemented by combining P action with the deviation suppression of I action and the oscillation suppression of D action. PID control features minimal control deviation, high precision and high stability.

In particular, PID control is effective to a system that has a long response time to the occurrence of deviation.

Follow the procedure below to set data to PID control function codes.

It is highly recommended that you adjust the PID control value while monitoring the system response waveform with an oscilloscope or equivalent. Repeat the following procedure to determine the optimal solution for each system.

- Increase the data of J03 (PID control P (Gain)) within the range where the feedback signal does not oscillate.
- Decrease the data of J04 (PID control I (Integral time)) within the range where the feedback signal does not oscillate.
- Increase the data of J05 (PID control D (Differential time)) within the range where the feedback signal does not oscillate.

Refining the system response waveforms is shown below.

1) Suppressing overshoot

Increase the data of J04 (Integral time) and decrease the data of J05 (Differential time.)

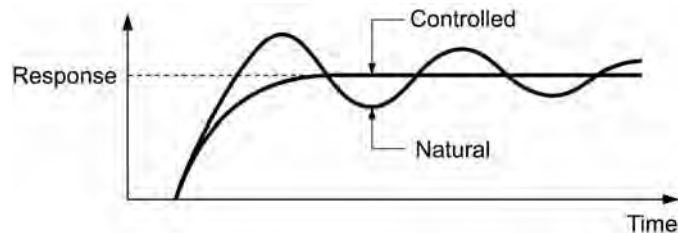

2) Quick stabilizing (moderate overshoot allowable)

Decrease the data of J03 (Gain) and increase that of J05 (Differential time).

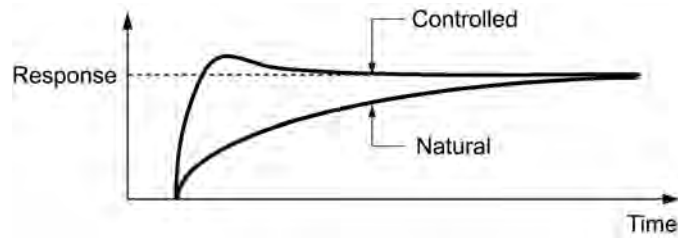

3) Suppressing oscillation whose period is longer than the integral time specified by J04

Increase the data of J04 (Integral time).

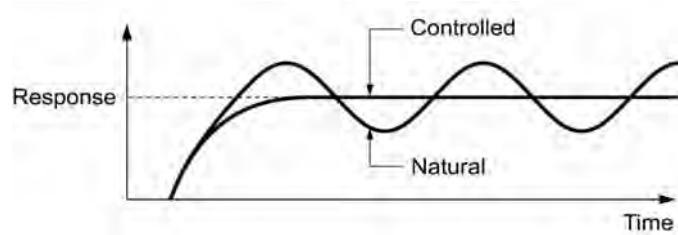

4) Suppressing oscillation whose period is approximately the same as the time specified by J05 (Differential time)

Decrease the data of J05 (Differential time).

Decrease the data of J03 (Gain), when the oscillation cannot be suppressed even if the differential time is set at 0 sec.

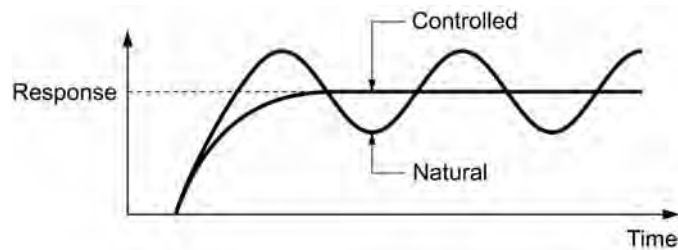

■ Feedback filter (J06)

J06 specifies the time constant of the filter for feedback signals under PID control.

- Data setting range: 0.0 to 900.0 (s)
- This setting is used to stabilize the PID control loop. Setting too long a time constant makes the system response slow.

Note To specify the filter for feedback signals in detail under PID dancer control, apply filter time constants for analog input (C33, C38 and C43).

J10**PID Control (Anti reset windup)**

J10 suppresses overshoot in control with PID processor. As long as the deviation between the feedback and the PID command is beyond the preset range, the integrator holds its value and does not perform integration operation.

- Data setting range: 0.0 to 200 (%)

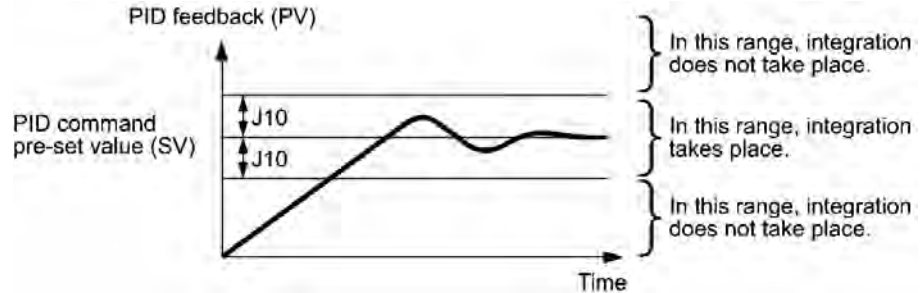
**J11****PID Control (Select alarm output)****J12****PID Control (Upper level alarm (AH))****J13****PID Control (Lower level alarm (AL))**

Two types of alarm signals can be output associated with PID control: absolute-value alarm and deviation alarm. You need to assign the PID alarm output **PID-ALM** to one of the digital output terminals (function code data = 42).

■ Select alarm output (J11)

J11 specifies the alarm type. The table below lists all the alarms available in the system.

Data for J11	Alarm	Description
0	Absolute-value alarm	While $PV < AL$ or $AH < PV$, PID-ALM is ON.
1	Absolute-value alarm (with Hold)	Same as above (with Hold)
2	Absolute-value alarm (with Latch)	Same as above (with Latch)
3	Absolute-value alarm (with Hold and Latch)	Same as above (with Hold and Latch)
4	Deviation alarm	While $PV < SV - AL$ or $SV + AH < PV$, PID-ALM is ON.

Data for J11	Alarm	Description
5	Deviation alarm (with Hold)	Same as above (with Hold)
6	Deviation alarm (with Latch)	Same as above (with Latch)
7	Deviation alarm (with Hold and Latch)	Same as above (with Hold and Latch)

Hold: During the power-on sequence, the alarm output is kept OFF (disabled) even when the monitored quantity is within the alarm range. Once it goes out of the alarm range, and comes into the alarm range again, the alarm is enabled.

Latch: Once the monitored quantity comes into the alarm range and the alarm is turned ON, the alarm will remain ON even if it goes out of the alarm range. To release the latch, perform a reset by using the  key or turning the **RST** terminal command ON, etc. Resetting can be done by the same way as resetting an alarm.

■ Upper level alarm (AH) (J12)

J12 specifies the upper limit of the alarm (AH) in percentage (%) of the feedback amount.

■ Lower level alarm (AL) (J13)

J13 specifies the lower limit of the alarm (AL) in percentage (%) of the feedback amount.

 The value displayed (%) is the ratio of the upper/lower limit to the full scale (10 V or 20 mA) of the feedback amount (in the case of a gain of 100%).

Upper level alarm (AH) and lower level alarm (AL) also apply to the following alarms.

Alarm	Description	How to handle the alarm:	
		Select alarm output (J11)	Parameter setting
Upper limit (absolute)	ON when $AH < PV$	Absolute-value alarm	J13 (AL) = 0
Lower limit (absolute)	ON when $PV < AL$		J12 (AH) = 100%
Upper limit (deviation)	ON when $SV + AH < PV$	Deviation alarm	J13 (AL) = 100%
Lower limit (deviation)	ON when $PV < SV - AL$		J12 (AH) = 100%
Upper/lower limit (deviation)	ON when $ SV - PV > AL$		J13 (AL) = J12 (AH)
Upper/lower range limit (deviation)	ON when $SV - AL < PV < SV + AL$	Deviation alarm	DO inverted
Upper/lower range limit (absolute)	ON when $AL < PV < AH$	Absolute-value alarm	DO inverted
Upper/lower range limit (deviation)	ON when $SV - AL < PV < SV + AH$	Deviation alarm	DO inverted

J18	PID Control (Upper limit of PID process output)
------------	--

J19	PID Control (Lower limit of PID process output)
------------	--

The upper and lower limiter can be specified to the PID output, exclusively used for PID control. The settings are ignored when PID cancel is enabled and the inverter is operated at the reference frequency previously specified.

■ PID Control (Upper limit of PID process output) (J18)

J18 specifies the upper limit of the PID processor output limiter in %. If you specify "999," the setting of the frequency limiter (High) (F15) will serve as the upper limit.

■ PID Control (Lower limit of PID process output) (J19)

J19 specifies the lower limit of the PID processor output limiter in %. If you specify "999," the setting of the frequency limiter (Low) (F16) will serve as the lower limit.

J56	PID Control (Speed command filter)
------------	---

Not used.

J57	PID Control (Dancer reference position)
------------	--

J57 specifies the dancer reference position in -100% to +100% for dancer control. The reference position can be specified as the function code from the keypad by this function code if J02 = 0 (keypad), or as typical operation of the PID command.

For the setting procedure of the PID command, refer to Chapter 3.

J58	PID Control (Detection width of dancer position deviation)
------------	---

J59	PID Control P (Gain) 2
------------	-------------------------------

J60	PID Control I (Integral time) 2
------------	--

J61	PID Control D (Differential time) 2
------------	--

The moment the feedback value of dancer roll position comes into the range of "the dancer reference position \pm the dancer reference position detection bandwidth (J58)," the inverter switches PID constants from the combination of J03, J04 and J05 to that of J59, J60 and J61, respectively in its PID processor. Giving a boost to the system response by raising the P gain may improve the system performance in the dancer roll positioning accuracy.

■ Detection width of dancer position deviation (J58)

J58 specifies the bandwidth in 1 to 100%. Specification of 0 does not switch PID constants.

■ P (Gain) 2 (J59)

■ I (Integral time) 2 (J60)

■ D (Differential time) 2 (J61)

Descriptions for J59, J60, and J61 are the same as those of PID control P (Gain) (J03), I (Integral time) (J04), and D (Differential time) (J05), respectively.

J62**PID Control (PID control block selection)**

This function code allows you to select either adding or subtracting the PID dancer control processor output to the primary speed command, and the PID processor output for the primary speed command either controls by the ratio (%) or compensates by the absolute value (Hz).

Data for J62			Control function	
Decimal	Bit 1	Bit 0	Control value type	Operation for the primary speed command
0	0	0	Absolute value (Hz)	Addition
1	0	1	Absolute value (Hz)	Subtraction
2	1	0	Ratio (%)	Addition
3	1	1	Ratio (%)	Subtraction

J63**Overload Stop (Detection value)****J64****Overload Stop (Detection level)****J65****Overload Stop (Mode selection)****J66****Overload Stop (Operation condition)****J67****Overload Stop (Timer)**

When the monitored status index of the load exceeds the detection level specified by J64 for the period specified by J67, the inverter activates the overload stop function according to operation specified by J65. Use this function for such as system protection from applying a load that cannot be allowed by the system characteristics or any reason on the system design or system in which the motor spindle is locked by a mechanical stopper.

■ Detection value (J63)

J63 specifies the detection value of status index to be monitored.

Data for J63	Detection value	Description
0	Output torque	To improve the accuracy of torque calculation, be sure to auto-tune the inverter for the applied motor. This setting covers the driving torque only.
1	Output current	The no-load current to the motor always flows. Specify J64 (Detection level) correctly considering the no-load current of the applied motor.

■ Detection level (J64)

J64 specifies the detection level putting the rated torque and current of the motor as 100%.

■ Mode selection (J65)

J65 specifies operation when the load amount exceeds that of one specified by J64.

Data for J65	Mode	Description
0	Disable	The inverter cancels the overload stop function.
1	Decelerate to stop	The inverter decelerate-to-stops the motor by the specified deceleration time.
2	Coast to a stop	The inverter shuts down the output immediately, and the motor coast-to-stops.
3	Mechanical stopper	The inverter decelerates the motor with the torque limit operation, and is controlling the output current to keep the hold torque until the run command turned OFF. Make the mechanical brake turn on before turning the run command OFF. The inverter issues an alarm <i>IOL</i> or <i>IOL2</i> during the mechanical stopper operation.



- Once the overload stop function is activated, the inverter holds it and cannot accelerate the motor again. To reaccelerate the motor, turn the run command OFF and ON again.
- If J65 = 3, the inverter ignores the driving torque limit operation already specified.

Configuration examples

Operation Selection J65 = 1 or 2

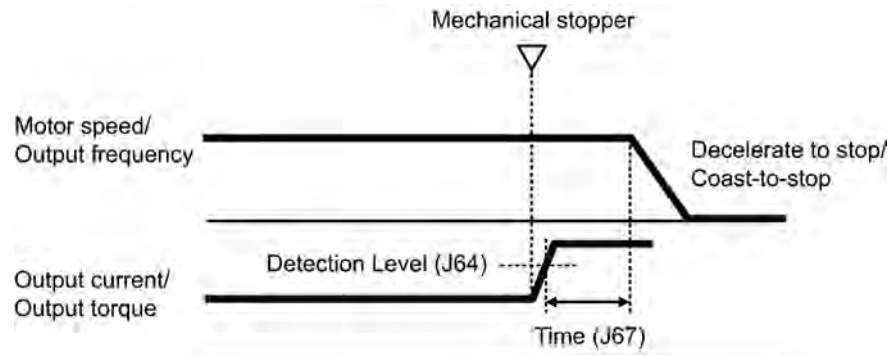

Operation selection J65 = 3

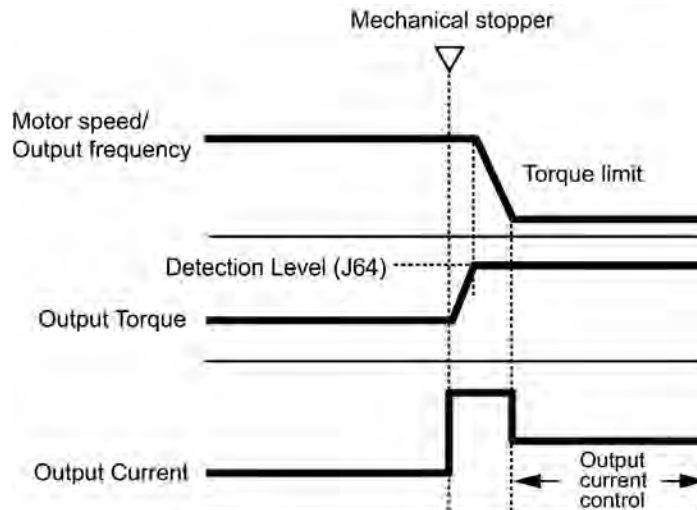

■ Operation condition (J66)

J66 specifies the inverter's operation state to apply the overload stop function.

Note that carefully specify it so as not to induce a malfunction by any setting that is not needed.

Data for J66	Applicable operation mode
0	Takes effect in the constant speed or deceleration operation mode.
1	Takes effect in the constant speed operation mode.
2	Takes effect in all the operation modes.

■ Timer (J67)

J67 configures the timer to suppress any activation of the overload stop function by any unexpected momentary load fluctuation.

If an activation condition of the overload stop function is taken for the time specified by the timer J67, the inverter activate it in case of J65 = 1 or 2.

 If J65 = 3, the timer setting is ignored. In this case, the inverter decelerates the motor instantaneously with the torque limit function so that referring to the timer is to interfere running of this function.

J68	Braking Signal (Brake OFF current)
J69	Braking Signal (Brake OFF frequency)
J70	Braking Signal (Brake OFF timer)
J71	Braking Signal (Brake ON frequency)
J72	Braking Signal (Brake ON timer)

These function codes are for the brake releasing/turning-on signals of hoisting/elevating machines.

Releasing the Brake

The inverter releases the brake (Terminal command **BRKS**: ON) after checking torque generation of the motor, monitoring whether it applies both the output current and frequency to the motor, which are higher than ones specified for the time long enough.

Function code	Name	Data setting range
J68	Brake OFF current	0 to 200%: Set it putting the inverter rated current at 100%.
J69	Brake OFF frequency	0.0 to 25.0 Hz
J70	Brake OFF timer	0.0 to 5.0 s

Turning-on the brake

To assure the service life of brake body, the inverter checks the motor speed lowering enough less than one specified, monitoring that the run command turns OFF and the output frequency lowers than one specified for the time long enough, and turn-on the brake (terminal command **BRKS**: OFF).

Function code	Name	Data setting range
J71	Brake ON frequency	0.0 to 25.0 Hz
J72	Brake ON timer	0.0 to 5.0 s



- The braking signal control is only applicable to motor 1. If the motor switching function selects motor 2, the braking signal always remains at state of turning-on.
- When an event such as an occurrence of alarm and turning the coast-to-stop terminal command **BX** ON shuts down the inverter, the braking signal turns-on immediately.

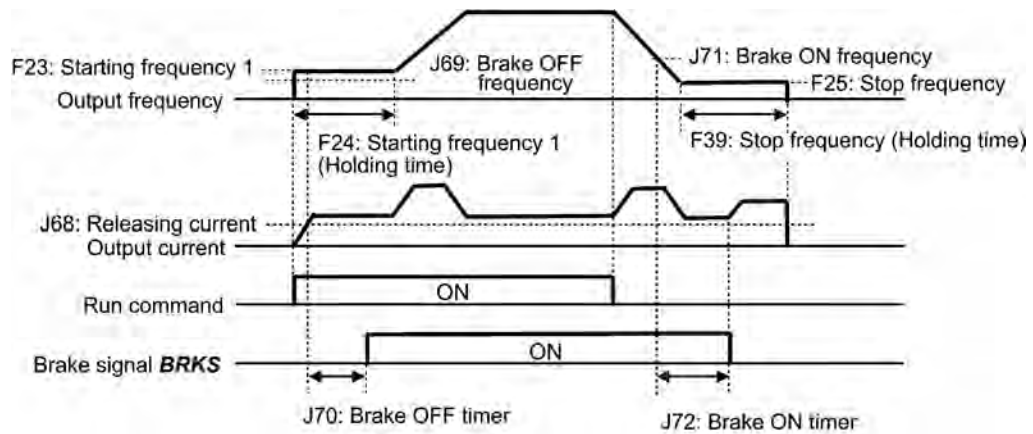

J73 to J86

Reserved*

* These are reserved for particular manufacturers. Do not access them.

9.2.8 y codes (Link functions)

y01 to y20

RS-485 Communication (Standard and option)

Up to two ports of RS-485 communications link are available, including the terminal block option as shown below.

Port	Route	Function code	Applicable equipment
Port 1	Standard RS-485 Communications (for connection with keypad) via RJ-45 port	y01 through y10	Standard keypad Multi-function keypad FRENIC Loader Host equipment
Port 2	Optional RS-485 communications card via the terminal port on the card	y11 through y20	Host equipment No FRENIC Loader supported

To connect any of the applicable devices, follow the procedures shown below.

(1) Standard keypad and optional multi-function keypad

The standard keypad and optional multi-function keypad allow you to run and monitor the inverter.

There is no need to set the y codes.

(2) FRENIC Loader

Using your PC running FRENIC Loader, you can monitor the inverter's running status information, edit function codes, and test-run the inverters.



For the setting of y codes, refer to function codes y01 to y10. For details, refer to the FRENIC Loader Instruction Manual.

(3) Host equipment

The inverter can be managed and monitored by connecting host equipment such as a PC and PLC to the inverter. Modbus RTU* and Fuji general-purpose inverter protocol are available for communications protocols.

*Modbus RTU is a protocol established by Modicon, Inc.



For details, refer to the RS-485 Communication User's Manual.

■ Station address (y01 for standard port and y11 for option port)

y01 and y11 specify the station address for the RS-485 communications link. The table below lists the protocols and the station address setting ranges.

Protocol	Station address	Broadcast address
Modbus RTU protocol	1 to 247	0
FRENIC Loader protocol	1 to 255	None
FUJI general-purpose inverter protocol	1 to 31	99

- If any wrong address beyond the above range is specified, no response is returned since the inverter will be unable to receive any enquiries except the broadcast message.
- To use FRENIC Loader, set the station address that matches the connected PC.

■ Communications error processing (y02 for standard port and y12 for option port)

y02 and y12 specify the operation performed when an RS-485 communications error has occurred.

RS-485 communications errors contain logical errors such as address error, parity error, framing error, and transmission protocol error, and physical errors such as communications disconnection error set by y08 and y18. In each case, these are judged as an error only when the inverter is running while the operation command or frequency command has been set to the configuration specified through RS-485 communications. When neither the operation command nor frequency command is issued through RS-485 communications, or the inverter is not running, error occurrence is not recognized.

Data for y02 and y12	Function
0	Immediately trip after showing an RS-485 communications error ($E_r\text{-}E$ for y02 and $E_r\text{-}P$ for y12). (The inverter stops with alarm issue.)
1	Run during the time set on the error processing timer (y03, y13), display an RS-485 communications error ($E_r\text{-}E$ for y02 and $E_r\text{-}P$ for y12), and then stop operation. (The inverter stops with alarm issue.)
2	Retry transmission during the time set on the error processing timer (y03, y13). If communications link is recovered, continue operation. Otherwise, display an RS-485 communications error ($E_r\text{-}E$ for y02 and $E_r\text{-}P$ for y12) and stop operation. (The inverter stops with alarm issue.)
3	Continue to run even when a communications error occurs.

 For details, refer to the RS-485 Communication User's Manual.

■ Timer (y03 and y13)

y03 or y13 specifies an error processing timer.

When the set timer count has elapsed because of no response on other end etc., if a response request was issued, the inverter interprets that an error occurs. See the section of "No-response error detection time (y08, y18)."

- Data setting range: 0.0 to 60.0 (s)

■ Baud rate (y04 and y14)

y04 and y14 specify the transmission speed for RS-485 communications.

- Setting for FRENIC Loader: Set the same transmission speed as that specified by the connected PC.

Data for y04 and y14	Transmission speed (bps)
0	2400
1	4800
2	9600
3	19200
4	38400

■ Data length (y05 and y15)

y05 and y15 specify the character length for transmission.

- Setting for FRENIC Loader: Loader sets the length in 8 bits automatically. (The same applies to the Modbus RTU protocol.)

Data for y05 and y15	Data length
0	8 bits
1	7 bits

■ Parity check (y06 and y16)

y06 and y16 specify the property of the parity bit.

- Setting for FRENIC Loader: Loader sets it to the even parity automatically.

Data for y06 and y16	Parity
0	None (2 stop bits for Modbus RTU)
1	Even parity (1 stop bit for Modbus RTU)
2	Odd parity (1 stop bit for Modbus RTU)
3	None (1 stop bit for Modbus RTU)

■ Stop bits (y07 and y17)

y07 and y17 specify the number of stop bits.

- Setting for FRENIC Loader: Loader sets it to 1 bit automatically.
For the Modbus RTU protocol, the stop bits are automatically determined associated with the property of parity bits. So no setting is required.

Data for y07 and y17	Stop bit(s)
0	2 bits
1	1 bit

■ No-response error detection time (y08 and y18)

y08 and y18 specify the time interval from the inverter detecting no access until it enters communications error alarm mode due to network failure and processes the communications error. This applies to a mechanical system that always accesses its station within a predetermined interval during communications using the RS-485 communications link.

Data for y08 and y18	Function
0	Disable
1 to 60	1 to 60 s

For the processing of communications errors, refer to y02 and y12.

■ Response interval (y09 and y19)

y09 and y19 specify the latency time after the end of receiving a query sent from the host equipment (such as a PC or PLC) to the start of sending the response. This function allows using equipment whose response time is slow while a network requires quick response, enabling the inverter to send a response timely by the latency time setting.

- Data setting range: 0.00 to 1.00 (s)

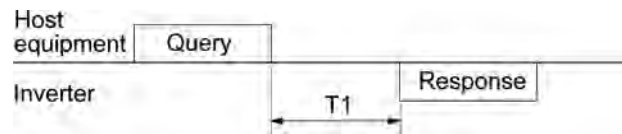

$$T1 = \text{Latency time} + \alpha$$

where α is the processing time inside the inverter. This time may vary depending on the processing status and the command processed in the inverter.

 For details, refer to the RS-485 Communication User's Manual.

 **Note** When setting the inverter with FRENIC Loader, pay sufficient attention to the performance and/or configuration of the PC and protocol converter such as RS-485–RS-232C communications level converter. Note that some protocol converters monitor the communications status and switch the send/receive of transmission data by a timer.

■ Protocol selection (y10)

y10 specifies the communications protocol for the standard RS-485 port.

- Specifying FRENIC loader to connect to the inverter can only be made by y10. Select FRENIC Loader (y10 = 1).

Data for y10	Protocol
0	Modbus RTU protocol
1	FRENIC Loader protocol
2	Fuji general-purpose inverter protocol

■ Protocol selection (y20)

y20 specifies the communications protocol for the optional communications port.

Data for y20	Protocol
0	Modbus RTU protocol
2	Fuji general-purpose inverter protocol

y98**Bus Link Function (Mode selection)
H30 (Communications Link Function, Mode selection)**

For setting data for y98 bus link function (Mode selection), refer to the description of function code H30.

y99**Loader Link Function (Mode selection)**

This is a link switching function for FRENIC Loader. Rewriting the data of y99 to enable RS-485 communications from Loader helps Loader send the inverter the frequency and/or run commands. Since the data to be set in the function code of the inverter is automatically set by Loader, no keypad operation is required. While Loader is selected as the source of the run command, if the PC runs out of control and cannot be stopped by a stop command sent from Loader, disconnect the RS-485 communications cable from the standard port (Keypad), connect a keypad instead, and reset the y99 to "0." This setting "0" in y99 means that the run and frequency command source specified by function code H30 takes place.

Note that the inverter cannot save the setting of y99. When power is turned off, the data in y99 is lost (y99 is reset to "0").

Data for y99	Function	
	Frequency command	Run command
0	Follow H30 and y98 data	Follow H30 and y98 data
1	Via RS-485 communications link (FRENIC Loader, S01 and S05)	Follow H30 and y98 data
2	Follow H30 and y98 data	Via RS-485 communications link (FRENIC Loader, S06)
3	Via RS-485 communications link (FRENIC Loader, S01 and S05)	Via RS-485 communications link (FRENIC Loader, S06)

Appendices

Contents

App.A	Advantageous Use of Inverters (Notes on electrical noise)	A-1
A.1	Effect of inverters on other devices	A-1
A.2	Noise	A-2
A.3	Noise prevention	A-4
App.B	Effect on Insulation of General-purpose Motors Driven with 460 V Class Inverters	A-12
B.1	Generating mechanism of surge voltages	A-12
B.2	Effect of surge voltages	A-13
B.3	Countermeasures against surge voltages	A-13
B.4	Regarding existing equipment	A-14
App.C	Inverter Generating Loss	A-15
App.D	Conversion from SI Units	A-16
App.E	Allowable Current of Insulated Wires	A-18
App.F	Replacement Information	A-20
F.1	External dimensions comparison tables	A-20
F.2	Terminal arrangements and symbols	A-23
F.3	Function codes	A-26

App.A Advantageous Use of Inverters (Notes on electrical noise)

- Disclaimer: This document provides you with a summary of the Technical Document of the Japan Electrical Manufacturers' Association (JEMA) (April 1994). It is intended to apply to the domestic market only. It is only for reference for the foreign market. -

A.1 Effect of inverters on other devices

Inverters have been and are rapidly expanding its application fields. This paper describes the effect that inverters have on electronic devices already installed or on devices installed in the same system as inverters, as well as introducing noise prevention measures. (Refer to Section A.3 [3], "Noise prevention examples" for details.)

[1] Effect on AM radios

Phenomenon If an inverter operates, AM radios may pick up noise radiated from the inverter. (An inverter has almost no effect on FM radios or television sets.)

Probable cause Radios may receive noise radiated from the inverter.

Measures Inserting a noise filter on the power supply side of the inverter is effective.

[2] Effect on telephones

Phenomenon If an inverter operates, nearby telephones may pick up noise radiated from the inverter in conversation so that it may be difficult to hear.

Probable cause A high-frequency leakage current radiated from the inverter and motors enters shielded telephone cables, causing noise.

Measures It is effective to commonly connect the grounding terminals of the motors and return the common grounding line to the grounding terminal of the inverter.

[3] Effect on proximity switches

Phenomenon If an inverter operates, proximity switches (capacitance-type) may malfunction.

Probable cause The capacitance-type proximity switches may provide inferior noise immunity.

Measures It is effective to connect a filter to the input terminals of the inverter or change the power supply treatment of the proximity switches. The proximity switches can be replaced with superior noise immunity types such as magnetic types.

[4] Effect on pressure sensors

Phenomenon If an inverter operates, pressure sensors may malfunction.

Probable cause Noise may penetrate through a grounding wire into the signal line.

Measures It is effective to install a noise filter on the power supply side of the inverter or to change the wiring.

[5] Effect on position detectors (pulse encoders)

Phenomenon If an inverter operates, pulse encoders may produce erroneous pulses that shift the stop position of a machine.

Probable cause Erroneous pulses are liable to occur when the signal lines of the PG and power lines are bundled together.

Measure The influence of induction noise and radiation noise can be reduced by separating the PG signal lines and power lines. Providing noise filters at the input and output terminals is also an effective measure.

A.2 Noise

This section gives a summary of noises generated in inverters and their effects on devices subject to noise.

[1] Inverter noise

Figure A.1 shows an outline of the inverter configuration. The inverter converts AC to DC (rectification) in a converter unit, and converts DC to AC (inversion) with 3-phase variable voltage and variable frequency. The conversion (inversion) is performed by PWM implemented by switching six transistors (IGBT: Insulated Gate Bipolar Transistor, etc), and is used for variable speed motor control.

Switching noise is generated by high-speed on/off switching of the six transistors. Noise current (i) is emitted and at each high-speed on/off switching, the noise current flows through stray capacitance (C) of the inverter, cable and motor to the ground. The amount of the noise current is expressed as follows:

$$i = C \cdot dv/dt$$

It is related to the stray capacitance (C) and dv/dt (switching speed of the transistors). Further, this noise current is related to the carrier frequency since the noise current flows each time the transistors are switched on or off.

In addition to the main circuit of the inverter, the DC-to-DC switching power regulator (DC/DC converter), which is the power source for the control circuit of the inverter, may be a noise source in the same principles as stated above.

The frequency band of this noise is less than approximately 30 to 40 MHz. Therefore, the noise will affect devices such as AM radios using low frequency band, but will not virtually affect FM radios and television sets using higher frequency than this frequency band.

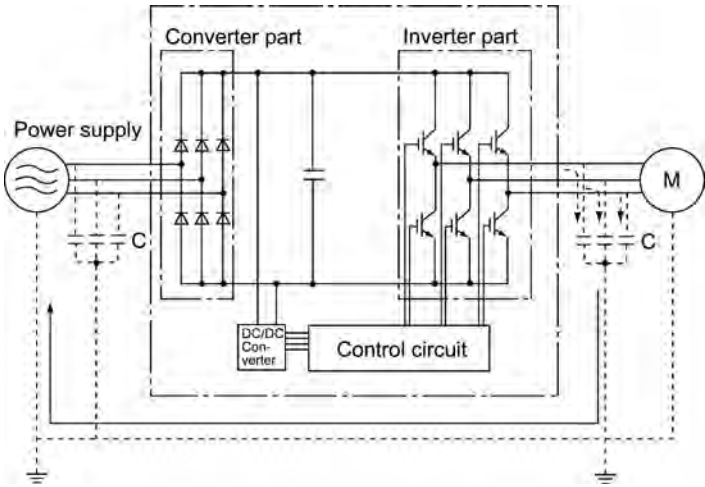

Figure A.1 Outline of Inverter Configuration

[2] Types of noise

Noise generated in an inverter is propagated through the main circuit wiring to the power supply and the motor so as to affect a wide range of applications from the power supply transformer to the motor. The various propagation routes are shown in Figure A.2. According to those routes, noises are roughly classified into three types--conduction noise, induction noise, and radiation noise.

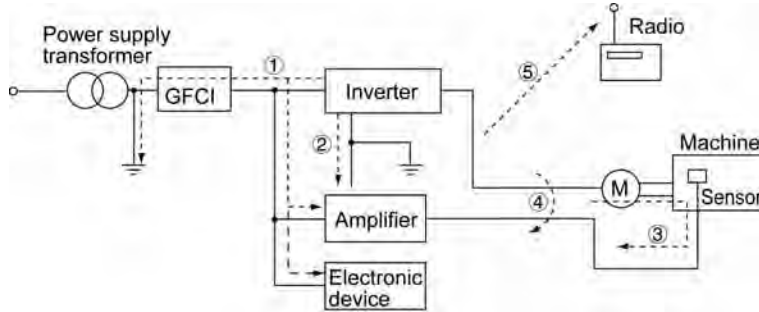

Figure A.2 Noise Propagation Routes

(1) Conduction noise

Noise generated in an inverter may propagate through the conductor and power supply so as to affect peripheral devices of the inverter (Figure A.3). This noise is called "conduction noise." Some conduction noises will propagate through the main circuit ①. If the ground wires are connected to a common ground, conduction noise will propagate through route ②. As shown in route ③, some conduction noises will propagate through signal lines or shielded wires.

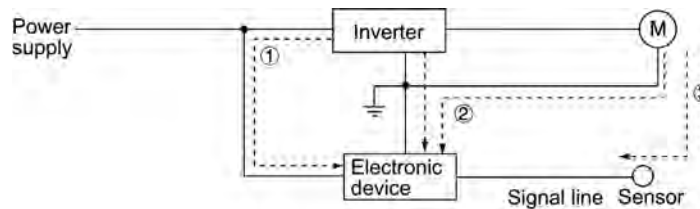

Figure A.3 Conduction Noise

(2) Induction noise

When wires or signal lines of peripheral devices are brought close to the wires on the input and output sides of the inverter through which noise current is flowing, noise will be induced into those wires and signal lines of the devices by electromagnetic induction (Figure A.4) or electrostatic induction (Figure A.5). This is called "induction noise" ④.

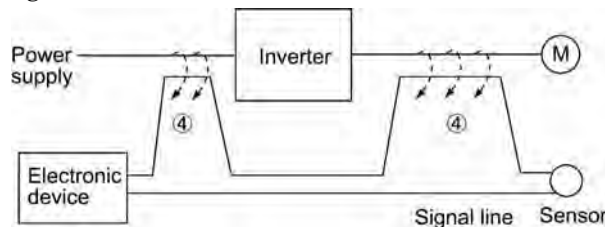

Figure A.4 Electromagnetic Induced Noise

App.

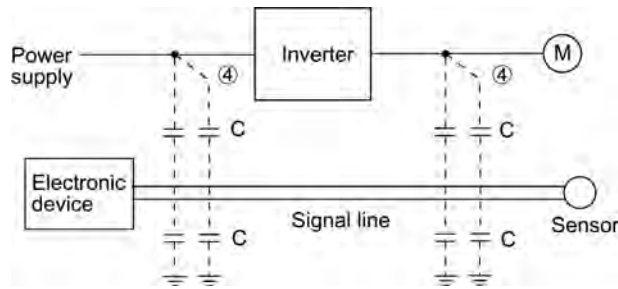

Figure A.5 Electrostatic Induced Noise

(3) Radiation noise

Noise generated in an inverter may be radiated through the air from wires (that act as antennas) at the input and output sides of the inverter so as to affect peripheral devices. This noise is called "radiation noise" ⑤ as shown below. Not only wires but motor frames or control system panels containing inverters may also act as antennas.

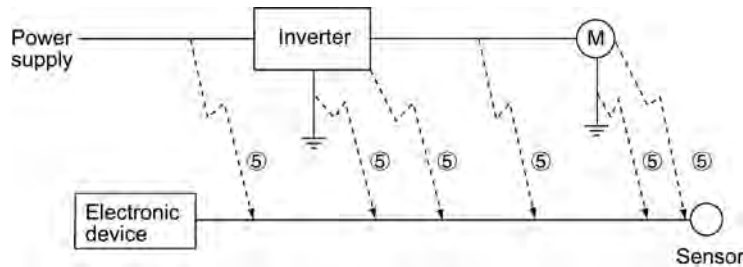

Figure A.6 Radiation Noise

A.3 Noise prevention

The more noise prevention is strengthened, the more effective. However, with the use of appropriate measures, noise problems may be resolved easily. It is necessary to implement economical noise prevention according to the noise level and the equipment conditions.

[1] Noise prevention prior to installation

Before installing an inverter in your control panel or installing an inverter panel, you need to consider noise prevention. Once noise problems occur, it will cost additional materials and time for solving them.

Noise prevention prior to installation includes:

- 1) Separating the wiring of main circuits and control circuits
- 2) Putting main circuit wiring into a metal conduit pipe
- 3) Using shielded wires or twisted shielded wires for control circuits.
- 4) Implementing appropriate grounding work and grounding wiring.

These noise prevention measures can avoid most noise problems.

[2] Implementation of noise prevention measures

There are two types of noise prevention measures--one for noise propagation routes and the other for noise receiving sides (that are affected by noise).

The basic measures for lessening the effect of noise at the receiving side include:

Separating the main circuit wiring from the control circuit wiring, avoiding noise effect.

The basic measures for lessening the effect of noise at the generating side include:

- 1) Inserting a noise filter that reduces the noise level.
- 2) Applying a metal conduit pipe or metal control panel that will confine noise, and
- 3) Applying an insulated transformer for the power supply that cuts off the noise propagation route.

Table A.1 lists the noise prevention measures, their goals, and propagation routes.

Table A.1 Noise Prevention Measures

Noise prevention method		Goal of noise prevention measures				Conduction route		
		Make it more difficult to receive noise	Cutoff noise conduction	Confine noise	Reduce noise level	Conduction noise	Induction noise	Radiation noise
Wiring and installation	Separate main circuit from control circuit	Y					Y	
	Minimize wiring distance	Y			Y		Y	Y
	Avoid parallel and bundled wiring	Y					Y	
	Use appropriate grounding	Y			Y	Y	Y	
	Use shielded wire and twisted shielded wire	Y					Y	Y
	Use shielded cable in main circuit			Y			Y	Y
	Use metal conduit pipe			Y			Y	Y
Control panel	Appropriate arrangement of devices in panel	Y					Y	Y
	Metal control panel			Y			Y	Y
Anti-noise device	Line filter	Y			Y	Y		Y
	Insulation transformer		Y			Y		Y
Measures at noise receiving sides	Use a passive capacitor for control circuit	Y					Y	Y
	Use ferrite core for control circuit	Y			Y		Y	Y
	Line filter	Y		Y		Y		
Others	Separate power supply systems		Y			Y		
	Lower the carrier frequency				Y*	Y	Y	Y

Y: Effective, Y*: Effective conditionally, Blank: Not effective

App.

What follows is noise prevention measures for the inverter drive configuration.

(1) Wiring and grounding

As shown in Figure A.7, separate the main circuit wiring from control circuit wiring as far as possible regardless of being located inside or outside the system control panel containing an inverter. Use shielded wires and twisted shielded wires that will block out extraneous noises, and minimize the wiring distance. Also avoid bundled wiring of the main circuit and control circuit or parallel wiring.

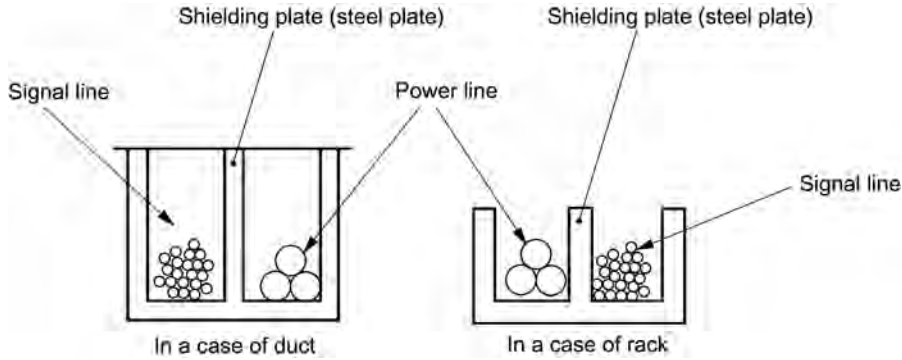

Figure A.7 Separate Wiring

For the main circuit wiring, use a metal conduit pipe and connect its wires to the ground to prevent noise propagation (refer to Figure A.8).

The shield (braided wire) of a shielded wire should be securely connected to the base (common) side of the signal line at only one point to avoid the loop formation resulting from a multi-point connection (refer to Figure A.9).

The grounding is effective not only to reduce the risk of electrical shocks due to leakage current, but also to block noise penetration and radiation. Corresponding to the main circuit voltage, the grounding work should be Class D (300 VAC or less, grounding resistance: 100Ω or less) and Class C (300 to 600 VAC, grounding resistance: 10Ω or less). Each ground wire is to be provided with its own ground or separately wired to a grounding point.

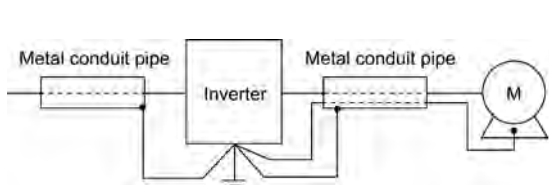

Figure A.8 Grounding of Metal Conduit Pipe

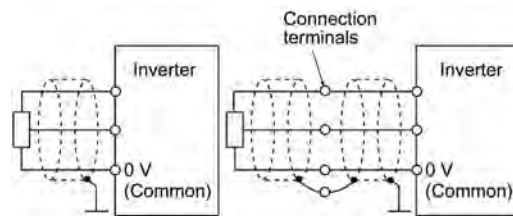

Figure A.9 Treatment of Braided Wire of Shielded Wire

(2) Control panel

The system control panel containing an inverter is generally made of metal, which can shield noise radiated from the inverter itself.

When installing other electronic devices such as a programmable logic controller in the same control panel, be careful with the layout of each device. If necessary, arrange shield plates between the inverter and peripheral devices.

(3) Anti-noise devices

To reduce the noise propagated through the electrical circuits and the noise radiated from the main circuit wiring to the air, a line filter and power supply transformer should be used (refer to Figure A.10).

Line filters are available in these types--the simplified type such as a capacitive filter to be connected in parallel to the power supply line and an inductive filter to be connected in series to the power supply line and the orthodox type such as an LC filter to meet radio noise regulations. Use them according to the targeted effect for reducing noise.

Power supply transformers include common insulated transformers, shielded transformers, and noise-cutting transformers. These transformers have different effectiveness in blocking noise propagation.

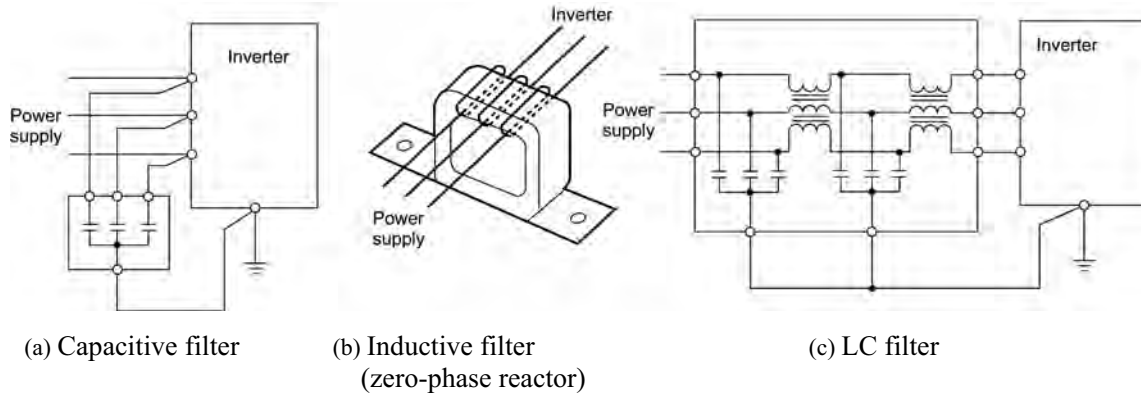

Figure A.10 Various Filters and their Connection

(4) Noise prevention measures at the receiving side

It is important to strengthen the noise immunity of those electronic devices installed in the same control panel as the inverter or located near an inverter. Line filters and shielded or twisted shielded wires are used to block the penetration of noise in the signal lines of these devices. The following treatments are also implemented.

- 1) Lower the circuit impedance by connecting capacitors or resistors to the input and output terminals of the signal circuit in parallel.
- 2) Increase the circuit impedance for noise by inserting choke coils in series in the signal circuit or passing signal lines through ferrite core beads. It is also effective to widen the signal base lines (0 V line) or grounding lines.

(5) Other

The level of generating/propagating noise will change with the carrier frequency of the inverter. The higher the carrier frequency, the higher the noise level.

In an inverter whose carrier frequency can be changed, lowering the carrier frequency can reduce the generation of electrical noise and result in a good balance with the audible noise of the motor under driving conditions.

[3] Noise prevention examples

Table A.2 lists examples of the measures to prevent noise generated by a running inverter.

Table A.2 Examples of Noise Prevention Measures

No.	Target device	Phenomena	Noise prevention measures	
				Notes
1	AM radio	<p>When operating an inverter, noise enters into an AM radio broadcast (500 to 1500 kHz).</p>  <p><Possible cause> The AM radio may receive noise radiated from wires at the power supply and output sides of the inverter.</p>	<ol style="list-style-type: none"> 1) Install an LC filter at the power supply side of the inverter. (In some cases, a capacitive filter may be used as a simple method.) 2) Install a metal conduit wiring between the motor and inverter.  <p>Note: Minimize the distance between the LC filter and inverter as short as possible (within 3.3ft (1m)).</p>	<ol style="list-style-type: none"> 1) The radiation noise of the wiring can be reduced. 2) The conduction noise to the power supply side can be reduced. <p>Note: Sufficient improvement may not be expected in narrow regions such as between mountains.</p>
2	AM radio	<p>When operating an inverter, noise enters into an AM radio broadcast (500 to 1500 kHz).</p>  <p><Possible cause> The AM radio may receive noise radiated from the power line at the power supply side of the inverter.</p>	<ol style="list-style-type: none"> 1) Install inductive filters at the input and output sides of the inverter.  <p>The number of turns of the zero-phase reactor (or ferrite ring) should be as large as possible. In addition, wiring between the inverter and the zero-phase reactor (or ferrite ring) should be as short as possible. (within 1m)</p> <ol style="list-style-type: none"> 2) When further improvement is necessary, install LC filters. 	<ol style="list-style-type: none"> 1) The radiation noise of the wiring can be reduced.

Table A.2 Continued

No.	Target device	Phenomena	Noise prevention measures	Notes
3	Tele- phone (in a common private residence at a distance of 131ft (40m))	<p>When driving a ventilation fan with an inverter, noise enters a telephone in a private residence at a distance of 131ft (40m).</p>  <p><Possible cause> A high-frequency leakage current from the inverter and motor flowed to grounded part of the telephone cable shield. During the current's return trip, it flowed through a grounded pole transformer, and noise entered the telephone by electrostatic induction.</p>	<p>1) Connect the ground terminals of the motors in a common connection. Return to the inverter panel, and insert a 1 μF capacitor between the input terminal of the inverter and ground.</p>  	<p>1) The effect of the inductive filter and LC filter may not be expected because of sound frequency component.</p> <p>2) In the case of a V-connection power supply transformer in a 230V system, it is necessary to connect capacitors as shown in the following figure, because of different potentials to ground.</p>
4	Photo- electric relay	<p>A photoelectric relay malfunctioned when the inverter runs the motor.</p> <p>[The inverter and motor are installed in the same place (for overhead traveling)]</p>  <p><Possible cause> It is considered that induction noise entered the photoelectric relay since the inverter's input power supply line and the photoelectric relay's wiring are in parallel separated by approximately 0.98inch (25mm) over a distance of 98 to 131ft (30 to 40m). Due to conditions of the installation, these lines cannot be separated.</p>	<p>1) As a temporary measure, Insert a 0.1 μF capacitor between the 0 V terminal of the power supply circuit in the detection unit of the overhead photoelectric relay and a frame of the overhead panel.</p>  <p>2) As a permanent measure, move the 24 V power supply from the ground to the overhead unit so that signals are sent to the ground side with relay contacts in the ceiling part.</p>	<p>1) The wiring is separated by more than 11.81inch (30 cm).</p> <p>2) When separation is impossible, signals can be received and sent with dry contacts etc.</p> <p>3) Do not wire low-current signal lines and power lines in parallel.</p>

App.

Table A.2 Continued

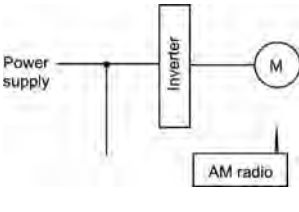
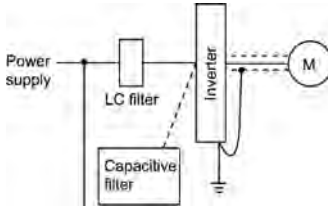
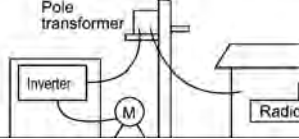
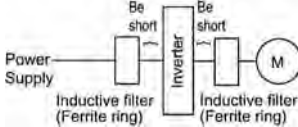
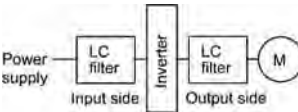
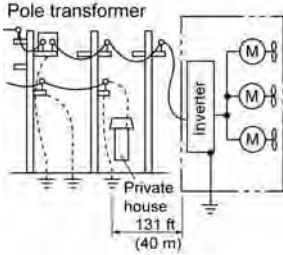
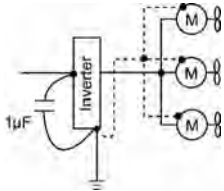
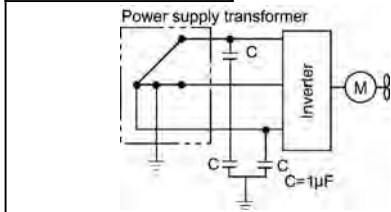
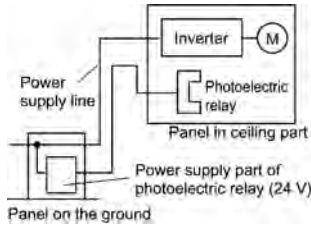
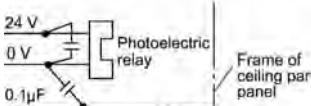
No.	Target device	Phenomena	Noise prevention measures	Notes
5	Photo-electric relay	<p>A photoelectric relay malfunctioned when the inverter was operated.</p>  <p><Possible cause> Although the inverter and photoelectric relay are separated by a sufficient distance but the power supplies share a common connection, it is considered that conduction noise entered through the power supply line into the photoelectric relay.</p>	<p>1) Insert a 0.1 μF capacitor between the output common terminal of the amplifier of the photoelectric relay and the frame.</p> 	<p>1) If a low-current circuit at the malfunctioning side is observed, the measures may be simple and economical.</p>
6	Prox-imity switch (capaci-tance type)	<p>A proximity switch malfunctioned.</p>  <p><Possible cause> It is considered that the capacitance type proximity switch is susceptible to conduction and radiation noise because of its low noise immunity.</p>	<p>1) Install an LC filter at the output side of the inverter. 2) Install a capacitive filter at the input side of the inverter. 3) Ground the 0 V (common) line of the DC power supply of the proximity switch through a capacitor to the box body of the machine.</p> 	<p>1) Noise generated in the inverter can be reduced. 2) The switch is superseded by a proximity switch of superior noise immunity (such as a magnetic type).</p>

Table A.2 Continued

No.	Target device	Phenomena	Noise prevention measures	Notes
7	Pressure sensor	<p>A pressure sensor malfunctioned.</p>  <p><Possible cause> The pressure sensor may malfunction due to noise that came from the box body through the shielded wire.</p>	<ol style="list-style-type: none"> 1) Install an LC filter on the input side of the inverter. 2) Connect the shield of the shielded wire of the pressure sensor to the 0 V line (common) of the pressure sensor, changing the original connection. 	<ol style="list-style-type: none"> 1) The shielded parts of shield wires for sensor signals are connected to a common point in the system. 2) Conduction noise from the inverter can be reduced.
8	Position detector (pulse encoder)	<p>Erroneous-pulse outputs from a pulse converter caused a shift in the stop position of a crane.</p>  <p><Possible cause> Erroneous pulses may be outputted by induction noise since the power line of the motor and the signal line of the PG are bundled together.</p>	<ol style="list-style-type: none"> 1) Install an LC filter and a capacitive filter at the input side of the inverter. 2) Install an LC filter at the output side of the inverter. 	<ol style="list-style-type: none"> 1) This is an example of a measure where the power line and signal line cannot be separated. 2) Induction noise and radiation noise at the output side of the inverter can be reduced.
9	Program mable logic controller (PLC)	<p>The PLC program sometimes malfunctions.</p>  <p><Possible cause> Since the power supply system is the same for the PLC and inverter, it is considered that noise enters the PLC through the power supply.</p>	<ol style="list-style-type: none"> 1) Install a capacitive filter and an LC filter on the input side of the inverter. 2) Install an LC filter on the output side of the inverter. 3) Lower the carrier frequency of the inverter. 	<ol style="list-style-type: none"> 1) Total conduction noise and induction noise in the electric line can be reduced.

App.

App.B Effect on Insulation of General-purpose Motors Driven with 460 V Class Inverters

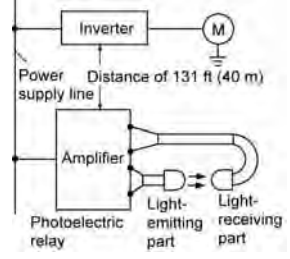
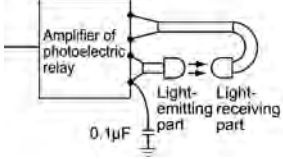
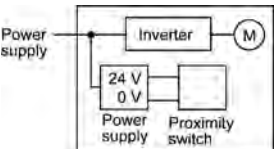
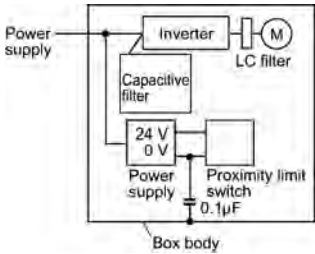
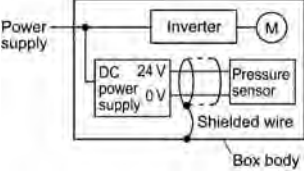
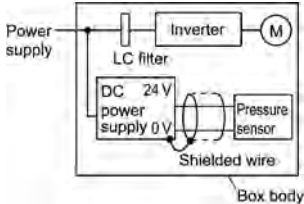
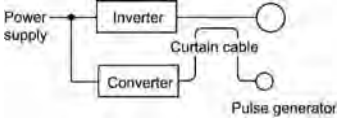
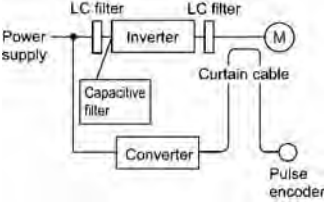
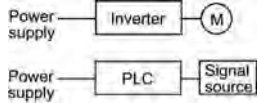
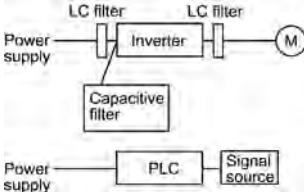
- Disclaimer: This document provides you with a summary of the Technical Document of the Japan Electrical Manufacturers' Association (JEMA) (March, 1995). It is intended to apply to the domestic market only. It is only for reference for the foreign market. -

Preface

When an inverter drives a motor, surge voltages generated by switching the inverter elements are superimposed on the inverter output voltage and applied to the motor terminals. If the surge voltages are too high they may have an effect on the motor insulation and some cases have resulted in damage.

For preventing such cases this document describes the generating mechanism of the surge voltages and countermeasures against them.

 Refer to A.2 [1] "Inverter noise" for details of the principle of inverter operation.

B.1 Generating mechanism of surge voltages

As the inverter rectifies a commercial power source voltage and smoothes into a DC voltage, the magnitude E of the DC voltage becomes about $\sqrt{2}$ times that of the source voltage (about 620 V in case of an input voltage of 440 VAC). The peak value of the output voltage is usually close to this DC voltage value.

But, as there exists inductance (L) and stray capacitance (C) in wiring between the inverter and the motor, the voltage variation due to switching the inverter elements causes a surge voltage originating in LC resonance and results in the addition of high voltage to the motor terminals. (Refer to Figure C.1)

This voltage sometimes reaches up to about twice that of the inverter DC voltage (620 V x 2 = approximately 1,200 V) depending on a switching speed of the inverter elements and wiring conditions.

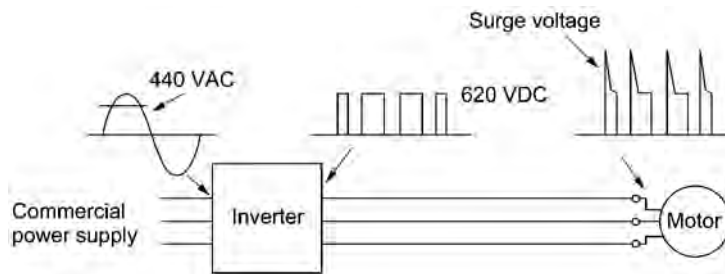
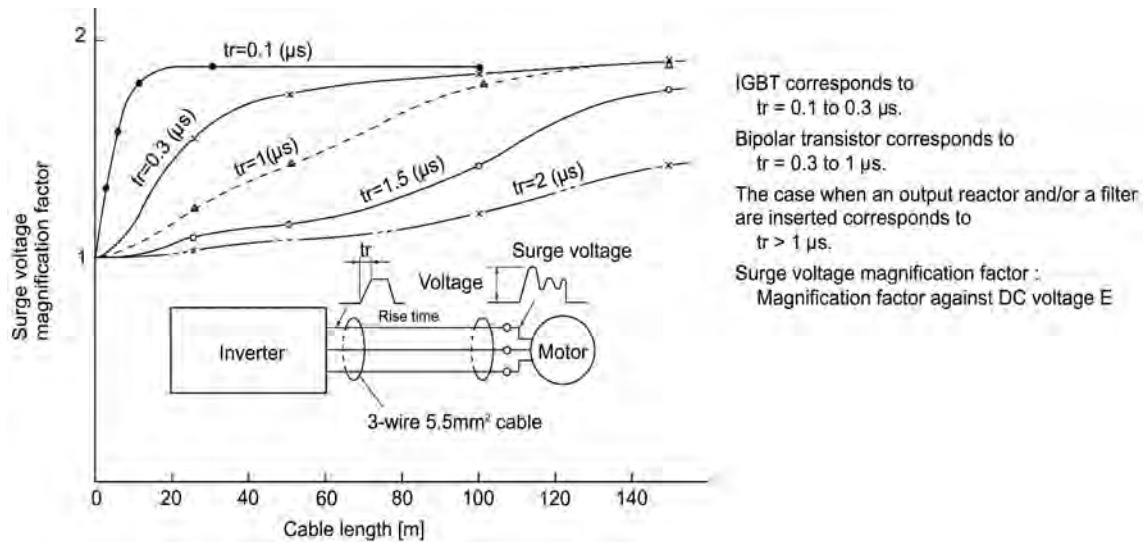

Figure C.1 Voltage Waveform of Individual Portions

A measured example in Figure C.2 illustrates the relation of a peak value of the motor terminal voltage with a wiring length between the inverter and the motor.

From this it can be confirmed that the peak value of the motor terminal voltage ascends as the wiring length increases and becomes saturated at about twice the inverter DC voltage.

The shorter a pulse rise time becomes, the higher the motor terminal voltage rises even in the case of a short wiring length.



Excerpt from [J. IEE Japan, Vol. 107, No. 7, 1987]

Figure C.2 Measured Example of Wiring Length and Peak Value of Motor Terminal Voltage

B.2 Effect of surge voltages

The surge voltages originating in LC resonance of wiring may be applied to the motor terminals and depending on their magnitude sometimes cause damage to the motor insulation.

When the motor is driven with a 230 V class inverter, the dielectric strength of the insulation is no problem since the peak value at the motor terminal voltage increases twice due to the surge voltages (the DC voltage is only about 300 V).

But in case of a 460 V class inverter, the DC voltage is approximately 600 V and depending on the wiring length, the surge voltages may greatly increase and sometimes result in damage to the insulation.

B.3 Countermeasures against surge voltages

When driving a motor with a 460 V class inverter, the following methods are countermeasures against damage to the motor insulation by the surge voltages.

[1] Method using motors with enhanced insulation

Enhanced insulation of a motor winding allows its surge withstanding to be improved.

[2] Method to suppress surge voltages

There are two methods for suppressing the surge voltages, one is to reduce the voltage rise time and another is to reduce the voltage peak value.

(1) Output reactor

If wiring length is relatively short, the surge voltages can be suppressed by reducing the voltage rise time (dv/dt) with the installation of an AC reactor on the output side of the inverter. (Refer to Figure C.3 (1).)

However, if the wiring length becomes long, suppressing the peak voltage due to surge voltage may be difficult.

(2) Output filter

Installing a filter on the output side of the inverter allows a peak value of the motor terminal voltage to be reduced. (Refer to Figure C.3 (2).)

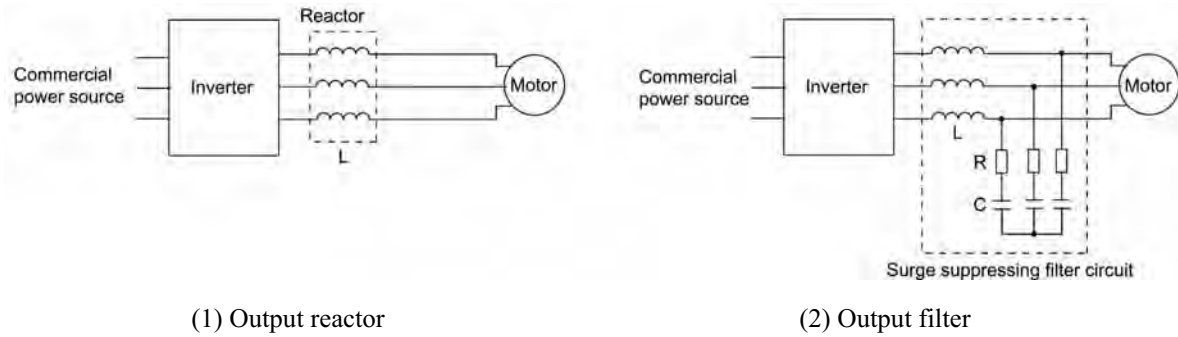

(1) Output reactor (2) Output filter
 Figure C.3 Method to Suppress Surge Voltage

B.4 Regarding existing equipment

[1] In case of a motor being driven with 460 V class inverter

A survey over the last five years on motor insulation damage due to the surge voltages originating from switching of inverter elements shows that the damage incidence is 0.013% under the surge voltage condition of over 1,100 V and most of the damage occurs several months after commissioning the inverter. Therefore there seems to be little probability of occurrence of motor insulation damage after a lapse of several months of commissioning.

[2] In case of an existing motor driven using a newly installed 460 V class inverter

We recommend suppressing the surge voltages with the method of Section C.3.

App.C Inverter Generating Loss

The table below lists the inverter generating loss.

Power supply voltage	Nominal applied motor (HP)	Inverter type	Generating loss (W)	
			Low carrier frequency (2 kHz)	High carrier frequency (15 kHz)
Three-phase 230 V	1/8	FRNF12E1S-2U	16	18
	1/4	FRNF25E1S-2U	23	27
	1/2	FRNF50E1S-2U	35	39
	1	FRN001E1S-2U	54	58
	2	FRN002E1S-2U	74	95
	3	FRN003E1S-2U	98	128
	5	FRN005E1S-2U	166	231
	7.5	FRN007E1S-2U	179	232
	10	FRN010E1S-2U	287	364
	15	FRN015E1S-2U	444	545
Three-phase 460 V	20	FRN020E1S-2U	527	700
	1/2	FRNF50E1S-4U	30	52
	1	FRN001E1S-4U	40	72
	2	FRN002E1S-4U	57	104
	3	FRN003E1S-4U	79	147
	5	FRN005E1S-4U	121	219
	7.5	FRN007E1S-4U	151	283
	10	FRN010E1S-4U	227	399
Single-phase 230 V	15	FRN015E1S-4U	302	499
	20	FRN020E1S-4U	332	602
	1/8	FRNF12E1S-7U	16	18
	1/4	FRNF25E1S-7U	23	27
	1/2	FRNF50E1S-7U	36	40
	1	FRN001E1S-7U	55	59
	2	FRN002E1S-7U	78	100
	3	FRN003E1S-7U	105	135

App.D Conversion from SI Units

All expressions given in Chapter 7, "SELECTING OPTIMAL MOTOR AND INVERTER CAPACITIES" are based on SI units (The International System of Units). This section explains how to convert expressions to other units.

[1] Conversion of units

(1) Force

- $1 \text{ (kgf)} \approx 9.8 \text{ (N)}$
- $1 \text{ (N)} \approx 0.102 \text{ (kgf)}$

(2) Torque

- $1 \text{ (kgf} \cdot \text{m)} \approx 9.8 \text{ (N} \cdot \text{m)}$
- $1 \text{ (N} \cdot \text{m)} \approx 0.102 \text{ (kgf} \cdot \text{m)}$

(3) Work and energy

- $1 \text{ (kgf} \cdot \text{m)} \approx 9.8 \text{ (N} \cdot \text{m)} = 9.8 \text{ (J)}$
 $= 9.8 \text{ (W} \cdot \text{s)}$

(4) Power

- $1 \text{ (kgf} \cdot \text{m/s)} \approx 9.8 \text{ (N} \cdot \text{m/s)} = 9.8 \text{ (J/s)}$ =
 9.8 (W)
- $1 \text{ (N} \cdot \text{m/s)} \approx 1 \text{ (J/s)} = 1 \text{ (W)}$
 $\approx 0.102 \text{ (kgf} \cdot \text{m/s)}$

(5) Rotation speed

- $1 \text{ (r/min)} = \frac{2\pi}{60} \text{ (rad/s)} \approx 0.1047 \text{ (rad/s)}$
- $1 \text{ (rad/s)} = \frac{60}{2\pi} \text{ (r/min)} \approx 9.549 \text{ (r/min)}$

(6) Inertia constant

- $J \text{ (kg} \cdot \text{m}^2)$: moment of inertia
- $GD^2 \text{ (kg} \cdot \text{m}^2)$: flywheel effect

- $GD^2 = 4 J$

- $J = \frac{GD^2}{4}$

(7) Pressure and stress

- $1 \text{ (mmAq)} \approx 9.8 \text{ (Pa)} \approx 9.8 \text{ (N/m}^2)$
- $1 \text{ (Pa)} \approx 1 \text{ (N/m}^2) \approx 0.102 \text{ (mmAq)}$
- $1 \text{ (bar)} \approx 100000 \text{ (Pa)} \approx 1.02 \text{ (kg} \cdot \text{cm}^2)$
- $1 \text{ (kg} \cdot \text{cm}^2) \approx 98000 \text{ (Pa)} \approx 980 \text{ (mbar)}$
- $1 \text{ atmospheric pressure} = 1013 \text{ (mbar)}$
 $= 760 \text{ (mmHg)} = 101300 \text{ (Pa)}$
 $\approx 1.033 \text{ (kg/cm}^2)$

[2] Calculation formula

(1) Torque, power, and rotation speed

- $P (W) \approx \frac{2\pi}{60} \cdot N (r/min) \cdot \tau (N \cdot m)$
- $P (W) \approx 1.026 \cdot N (r/min) \cdot T (kgf \cdot m)$
- $\tau (N \cdot m) \approx 9.55 \cdot \frac{P (W)}{N (r/min)}$
- $T (kgf \cdot m) \approx 0.974 \cdot \frac{P (W)}{N (r/min)}$

(2) Kinetic energy

- $E (J) \approx \frac{1}{182.4} \cdot J (kg \cdot m^2) \cdot N^2 [(r/min)^2]$
- $E (J) \approx \frac{1}{730} \cdot GD^2 (kg \cdot m^2) \cdot N^2 [(r/min)^2]$

(3) Torque of linear moving load

Driving mode

- $\tau (N \cdot m) \approx 0.159 \cdot \frac{V (m/min)}{N_M (r/min) \cdot \eta_G} \cdot F (N)$
- $T (kgf \cdot m) \approx 0.159 \cdot \frac{V (m/min)}{N_M (r/min) \cdot \eta_G} \cdot F (kgf)$

Braking mode

- $\tau (N \cdot m) \approx 0.159 \cdot \frac{V (m/min)}{N_M (r/min) / \eta_G} \cdot F (N)$
- $T (kgf \cdot m) \approx 0.159 \cdot \frac{V (m/min)}{N_M (r/min) / \eta_G} \cdot F (kgf)$

(4) Acceleration torque

Driving mode

- $\tau (N \cdot m) \approx \frac{J (kg \cdot m^2)}{9.55} \cdot \frac{\Delta N (r/min)}{\Delta t (s) \cdot \eta_G}$
- $T (kgf \cdot m) \approx \frac{GD^2 (kg \cdot m^2)}{375} \cdot \frac{\Delta N (r/min)}{\Delta t (s) \cdot \eta_G}$

Braking mode

- $\tau (N \cdot m) \approx \frac{J (kg \cdot m^2)}{9.55} \cdot \frac{\Delta N (r/min) \cdot \eta_G}{\Delta t (s)}$
- $T (kgf \cdot m) \approx \frac{GD^2 (kg \cdot m^2)}{375} \cdot \frac{\Delta N (r/min) \cdot \eta_G}{\Delta t (s)}$

(5) Acceleration time

- $t_{ACC} (s) \approx \frac{J_1 + J_2 / \eta_G (kg \cdot m^2)}{\tau_M - \tau_L / \eta_G (N \cdot m)} \cdot \frac{\Delta N (r/min)}{9.55}$
- $t_{ACC} (s) \approx \frac{GD_1^2 + GD_2^2 / \eta_G (kg \cdot m^2)}{T_M - T_L / \eta_G (kgf \cdot m)} \cdot \frac{\Delta N (r/min)}{375}$

(6) Deceleration time

- $t_{DEC} (s) \approx \frac{J_1 + J_2 \cdot \eta_G (kg \cdot m^2)}{\tau_M - \tau_L \cdot \eta_G (N \cdot m)} \cdot \frac{\Delta N (r/min)}{9.55}$
- $t_{DEC} (s) \approx \frac{GD_1^2 + GD_2^2 \cdot \eta_G (kg \cdot m^2)}{T_M - T_L \cdot \eta_G (kgf \cdot m)} \cdot \frac{\Delta N (r/min)}{375}$

App.E Allowable Current of Insulated Wires

The tables below list the allowable current of IV wires, HIV wires, and 600 V cross-linked polyethylene insulated wires.

■ IV wires (Maximum allowable temperature: 60°C (140°F))

Table F.1 (a) Allowable Current of Insulated Wires

Wire size (mm ²)	Allowable current reference value (up to 30°C) I ₀ (A)	Aerial wiring					Wiring in the duct (Max. 3 wires in one duct)			
		35°C[95°F] (I ₀ ×0.91) (A)	40°C[104°F] (I ₀ ×0.82) (A)	45°C[113°F] (I ₀ ×0.71) (A)	50°C[122°F] (I ₀ ×0.58) (A)	55°C[131°F] (I ₀ ×0.40) (A)	35°C[95°F] (I ₀ ×0.63) (A)	40°C[104°F] (I ₀ ×0.57) (A)	45°C[113°] (I ₀ ×0.49) (A)	50°C[122°F] (I ₀ ×0.40) (A)
2.0	27	24	22	19	15	11	17	15	13	10
3.5	37	33	30	26	21	15	23	21	18	14
5.5	49	44	40	34	28	20	30	27	24	19
8.0	61	55	50	43	35	25	38	34	29	24
14	88	80	72	62	51	36	55	50	43	35
22	115	104	94	81	66	47	72	65	56	46
38	162	147	132	115	93	66	102	92	79	64
60	217	197	177	154	125	88	136	123	106	86
100	298	271	244	211	172	122	187	169	146	119
150	395	359	323	280	229	161	248	225	193	158
200	469	426	384	332	272	192	295	267	229	187
250	556	505	455	394	322	227	350	316	272	222
325	650	591	533	461	377	266	409	370	318	260
400	745	677	610	528	432	305	469	424	365	298
500	842	766	690	597	488	345	530	479	412	336
2 x 100	497	452	407	352	288	203	313	283	243	198
2 x 150	658	598	539	467	381	269	414	375	322	263
2 x 200	782	711	641	555	453	320	492	445	383	312
2 x 250	927	843	760	658	537	380	584	528	454	370
2 x 325	1083	985	888	768	628	444	682	617	530	433
2 x 400	1242	1130	1018	881	720	509	782	707	608	496
2 x 500	1403	1276	1150	996	813	575	883	799	687	561

■ HIV wires (Maximum allowable temperature: 75°C (167°F))

Table F.1 (b) Allowable Current of Insulated Wires

Wire size (mm ²)	Allowable current reference value (up to 30°C) I ₀ (A)	Aerial wiring					Wiring in the duct (Max. 3 wires in one duct)			
		35°C[95°F] (I ₀ ×0.91) (A)	40°C[104°F] (I ₀ ×0.82) (A)	45°C[113°F] (I ₀ ×0.71) (A)	50°C[122°F] (I ₀ ×0.58) (A)	55°C[131°F] (I ₀ ×0.40) (A)	35°C[95°F] (I ₀ ×0.63) (A)	40°C[104°F] (I ₀ ×0.57) (A)	45°C[113°] (I ₀ ×0.49) (A)	50°C[122°F] (I ₀ ×0.40) (A)
2.0	32	31	29	27	24	22	21	20	18	17
3.5	45	42	39	37	33	30	29	27	25	23
5.5	59	56	52	49	44	40	39	36	34	30
8.0	74	70	65	61	55	50	48	45	42	38
14	107	101	95	88	80	72	70	66	61	55
22	140	132	124	115	104	94	92	86	80	72
38	197	186	174	162	147	132	129	121	113	102
60	264	249	234	217	197	177	173	162	151	136
100	363	342	321	298	271	244	238	223	208	187
150	481	454	426	395	359	323	316	296	276	248
200	572	539	506	469	426	384	375	351	328	295
250	678	639	600	556	505	455	444	417	389	350
325	793	747	702	650	591	533	520	487	455	409
400	908	856	804	745	677	610	596	558	521	469
500	1027	968	909	842	766	690	673	631	589	530
2 x 100	606	571	536	497	452	407	397	372	347	313
2 x 150	802	756	710	658	598	539	526	493	460	414
2 x 200	954	899	844	782	711	641	625	586	547	492
2 x 250	1130	1066	1001	927	843	760	741	695	648	584
2 x 325	1321	1245	1169	1083	985	888	866	812	758	682
2 x 400	1515	1428	1341	1242	1130	1018	993	931	869	782
2 x 500	1711	1613	1515	1403	1276	1150	1122	1052	982	883

■ 600 V Cross-linked Polyethylene Insulated wires
(Maximum allowable temperature: 90°C (194°F))

Table F.1 (c) Allowable Current of Insulated Wires

Wire size (mm ²)	Allowable current reference value (up to 30°C) I ₀ (A)	Aerial wiring					Wiring in the duct (Max. 3 wires in one duct)			
		35°C[95°F] (I ₀ ×0.91) (A)	40°C[104°F] (I ₀ ×0.82) (A)	45°C[113°F] (I ₀ ×0.71) (A)	50°C[122°F] (I ₀ ×0.58) (A)	55°C[131°F] (I ₀ ×0.40) (A)	35°C[95°F] (I ₀ ×0.63) (A)	40°C[104°F] (I ₀ ×0.57) (A)	45°C[113°] (I ₀ ×0.49) (A)	50°C[122°F] (I ₀ ×0.40) (A)
2.0	38	36	34	32	31	29	25	24	22	21
3.5	52	49	47	45	42	39	34	33	31	29
5.5	69	66	63	59	56	52	46	44	41	39
8.0	86	82	78	74	70	65	57	54	51	48
14	124	118	113	107	101	95	82	79	74	70
22	162	155	148	140	132	124	108	103	97	92
38	228	218	208	197	186	174	152	145	137	129
60	305	292	279	264	249	234	203	195	184	173
100	420	402	384	363	342	321	280	268	253	238
150	556	533	509	481	454	426	371	355	335	316
200	661	633	605	572	539	506	440	422	398	375
250	783	750	717	678	639	600	522	500	472	444
325	916	877	838	793	747	702	611	585	552	520
400	1050	1005	961	908	856	804	700	670	633	596
500	1187	1136	1086	1027	968	909	791	757	715	673
2 x 100	700	670	641	606	571	536	467	447	422	397
2 x 150	927	888	848	802	756	710	618	592	559	526
2 x 200	1102	1055	1008	954	899	844	735	703	664	625
2 x 250	1307	1251	1195	1130	1066	1001	871	834	787	741
2 x 325	1527	1462	1397	1321	1245	1169	1018	974	920	866
2 x 400	1751	1676	1602	1515	1428	1341	1167	1117	1055	993
2 x 500	1978	1894	1809	1711	1613	1515	1318	1262	1192	1122

App.F Replacement Information

When replacing Fuji conventional inverter series (FVR-E9S, FVR-E11S) with the FRENIC-Multi series, refer to the replacement information given in this section.

F.1 External dimensions comparison tables

Below is a guide that helps in using the comparison tables on the following pages.

- Mounting area /Multi (%) Allows comparing the mounting area required for the FRENIC-Multi series with that for the conventional inverter series in percentage, assuming the area for the FRENIC-Multi series to be 100%. If this value is greater than 100%, it means that the mounting area required for the FRENIC-Multi series is smaller than that of other series.
- Volume/Multi (%) Allows comparing the volume of the FRENIC-Multi series with that of the conventional inverter series in percentage, assuming the volume of the FRENIC-Multi series to be 100%. If this value is greater than 100%, it means that the volume of the FRENIC-Multi is smaller than that of other series.
- In the FRENIC-Multi columns, dimensions in shaded boxes () denote that they are smaller than those of FVR-E9S and FVR-E11S series.
- In the FVR-E9S and FVR-E11S columns, underlined and bolded dimensions denote that they are smaller than those of the FRENIC-Multi series.

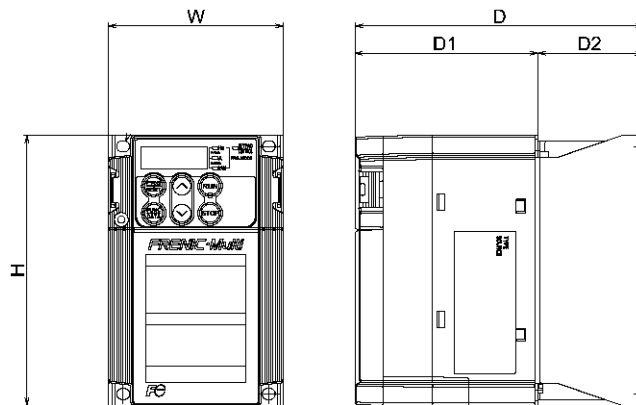

F.1.1 Standard models

FVR-E9S vs. FRENIC-Multi

		FVR-E9S (IP20) (Ambient temperature: 50°C)									FRENIC-Multi (IP20) (Ambient temperature: 50°C)							
		Nominal applied motor (kW)	External dimensions (mm)					Mounting area		Volume		External dimensions (mm)					Mounting area	Volume
			W	H	D	D1	D2	m ² (x10 ⁻²)	/Multi (%)	m ³ (x10 ⁻³)	/Multi (%)	W	H	D	D1	D2	m ² (x10 ⁻²)	m ³ (x10 ⁻³)
Three-phase 200 V	0.1	105	150	<u>72</u>	<u>63</u>	<u>9</u>	1.6	164.1	1.1	128.4	80	120	92	82	10	1.0	0.9	
	0.2	105	150	<u>80</u>	<u>63</u>	17	1.6	164.1	1.3	142.7	80	120	92	82	10	1.0	0.9	
	0.4	105	150	<u>90</u>	<u>63</u>	27	1.6	164.1	1.4	138.0	80	120	107	82	25	1.0	1.0	
	0.75	105	150	<u>119</u>	<u>63</u>	56	1.6	164.1	1.9	147.9	80	120	132	82	50	1.0	1.3	
	1.5	140	150	<u>119</u>	<u>63</u>	<u>56</u>	2.1	146.9	2.5	116.5	110	130	150	86	64	1.4	2.1	
	2.2	200	150	<u>134</u>	<u>63</u>	71	3.0	209.8	4.0	187.4	110	130	150	86	64	1.4	2.1	
	3.7	200	<u>150</u>	<u>149</u>	<u>63</u>	86	3.0	119.0	4.5	117.5	140	180	151	87	64	2.5	3.8	
	5.5	-	-	-	-	-	-	-	-	-	180	220	158	81	77	4.0	6.3	
	7.5	-	-	-	-	-	-	-	-	-	180	220	158	81	77	4.0	6.3	
	11	-	-	-	-	-	-	-	-	-	220	260	195	98.5	96.5	5.7	11.2	
15	-	-	-	-	-	-	-	-	-	220	260	195	98.5	96.5	5.7	11.2		
Three-phase 400 V	0.4	-	-	-	-	-	-	-	-	-	110	130	126	86	40	1.4	1.8	
	0.75	-	-	-	-	-	-	-	-	-	110	130	150	86	64	1.4	2.1	
	1.5	-	-	-	-	-	-	-	-	-	110	130	150	86	64	1.4	2.1	
	2.2	-	-	-	-	-	-	-	-	-	110	130	150	86	64	1.4	2.1	
	3.7	-	-	-	-	-	-	-	-	-	140	180	151	87	64	2.5	3.8	
	5.5	-	-	-	-	-	-	-	-	-	180	220	158	81	77	4.0	6.3	
	7.5	-	-	-	-	-	-	-	-	-	180	220	158	81	77	4.0	6.3	
	11	-	-	-	-	-	-	-	-	-	220	260	195	98.5	96.5	5.7	11.2	
15	-	-	-	-	-	-	-	-	-	220	260	195	98.5	96.5	5.7	11.2		
Single-phase 200 V	0.1	105	150	<u>72</u>	<u>63</u>	<u>9</u>	1.6	164.1	1.1	105.5	80	120	112	102	10	1.0	1.1	
	0.2	105	150	<u>80</u>	<u>63</u>	17	1.6	164.1	1.3	117.2	80	120	112	102	10	1.0	1.1	
	0.4	140	150	<u>109</u>	<u>63</u>	46	2.1	218.8	2.3	187.7	80	120	127	102	25	1.0	1.2	
	0.75	140	150	<u>109</u>	<u>63</u>	<u>46</u>	2.1	218.8	2.3	156.9	80	120	152	102	50	1.0	1.5	
	1.5	200	150	<u>134</u>	<u>63</u>	71	3.0	209.8	4.0	175.7	110	130	160	96	64	1.4	2.3	
	2.2	200	<u>150</u>	<u>134</u>	<u>63</u>	71	3.0	119.0	4.0	105.6	140	180	151	87	64	2.5	3.8	

App.

FVR-E11S vs. FRENIC-Multi

		FVR-E11S (IP20) (Ambient temperature: 50°C)									FRENIC-Multi (IP20) (Ambient temperature: 50°C)						
		External dimensions (mm)					Mounting area		Volume		External dimensions (mm)					Mounting area	Volume
		W	H	D	D1	D2	m ² (x10 ⁻²)	/Multi (%)	m ³ (x10 ⁻³)	/Multi (%)	W	H	D	D1	D2	m ² (x10 ⁻²)	m ³ (x10 ⁻³)
Three-phase 200 V	0.1	70	130	96	86	10	0.9	94.8	0.9	98.9	80	120	92	82	10	1.0	0.9
	0.2	70	130	101	86	15	0.9	94.8	0.9	104.1	80	120	92	82	10	1.0	0.9
	0.4	70	130	118	86	32	0.9	94.8	1.1	104.5	80	120	107	82	25	1.0	1.0
	0.75	70	130	144	86	58	0.9	94.8	1.3	103.4	80	120	132	82	50	1.0	1.3
	1.5	106	130	150	86	64	1.4	96.4	2.1	96.4	110	130	150	86	64	1.4	2.1
	2.2	106	130	150	86	64	1.4	96.4	2.1	96.4	110	130	150	86	64	1.4	2.1
	3.7	170	130	158	86	72	2.2	87.7	3.5	91.8	140	180	151	87	64	2.5	3.8
	5.5	180	220	158	-	-	4.0	100.0	6.3	100.0	180	220	158	81	77	4.0	6.3
	7.5	180	220	158	-	-	4.0	100.0	6.3	100.0	180	220	158	81	77	4.0	6.3
	11	-	-	-	-	-	-	-	-	-	220	260	195	98.5	96.5	5.7	11.2
15	-	-	-	-	-	-	-	-	-	220	260	195	98.5	96.5	5.7	11.2	
Three-phase 400 V	0.4	106	130	126	86	40	1.4	96.4	1.7	96.4	110	130	126	86	40	1.4	1.8
	0.75	106	130	150	86	64	1.4	96.4	2.1	96.4	110	130	150	86	64	1.4	2.1
	1.5	106	130	170	106	64	1.4	96.4	2.3	109.2	110	130	150	86	64	1.4	2.1
	2.2	106	130	170	106	64	1.4	96.4	2.3	109.2	110	130	150	86	64	1.4	2.1
	3.7	170	130	158	86	72	2.2	87.7	3.5	91.8	140	180	151	87	64	2.5	3.8
	5.5	180	220	158	-	-	4.0	100.0	6.3	100.0	180	220	158	81	77	4.0	6.3
	7.5	180	220	158	-	-	4.0	100.0	6.3	100.0	180	220	158	81	77	4.0	6.3
	11	-	-	-	-	-	-	-	-	-	220	260	195	98.5	96.5	5.7	11.2
	15	-	-	-	-	-	-	-	-	-	220	260	195	98.5	96.5	5.7	11.2
Single-phase 200 V	0.1	70	130	96	86	10	0.9	94.8	0.9	81.3	80	120	112	102	10	1.0	1.1
	0.2	70	130	101	86	15	0.9	94.8	0.9	85.5	80	120	112	102	10	1.0	1.1
	0.4	70	130	118	86	32	0.9	94.8	1.1	88.1	80	120	127	102	25	1.0	1.2
	0.75	106	130	126	86	40	1.4	143.5	1.7	119.0	80	120	152	102	50	1.0	1.5
	1.5	170	130	158	86	72	2.2	154.5	3.5	152.6	110	130	160	96	64	1.4	2.3
	2.2	170	130	158	86	72	2.2	87.7	3.5	91.8	140	180	151	87	64	2.5	3.8

F.2 Terminal arrangements and symbols

This section shows the difference in the terminal arrangements and their symbols between the FRENIC-Multi series and the replaceable inverter series.

FVR-E9S vs. FRENIC-Multi

FVR-E9S

Three-phase 230 V, 1/8 to 1/4 HP

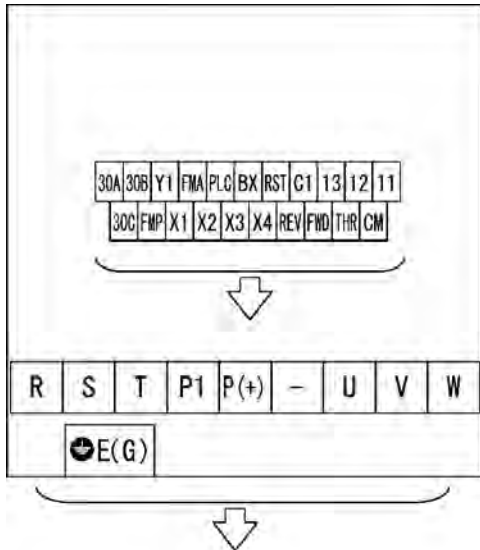

Three-phase 230 V, 1/2 to 5 HP
Three-phase 460 V, 1/2 to 5 HP

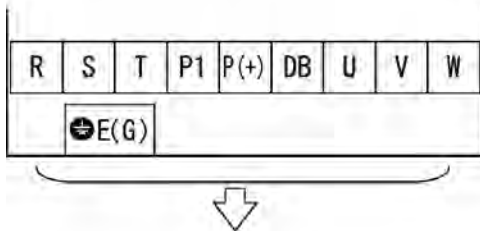

Single-phase 230 V, 1/8 to 1 HP

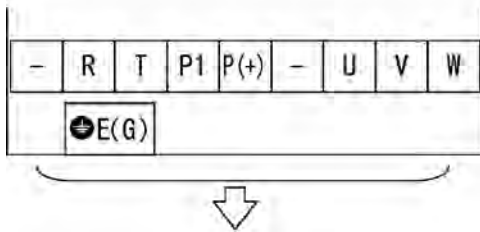

Single-phase 230 V, 2 to 3 HP

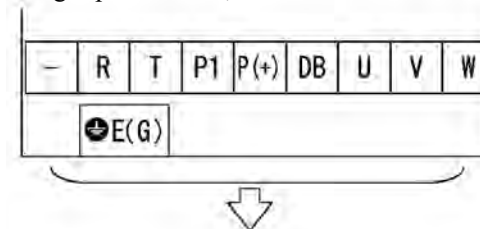

↓ : Direction of wire guide

FRENIC-Multi

Three-phase 230 V, 1/8 to 1 HP

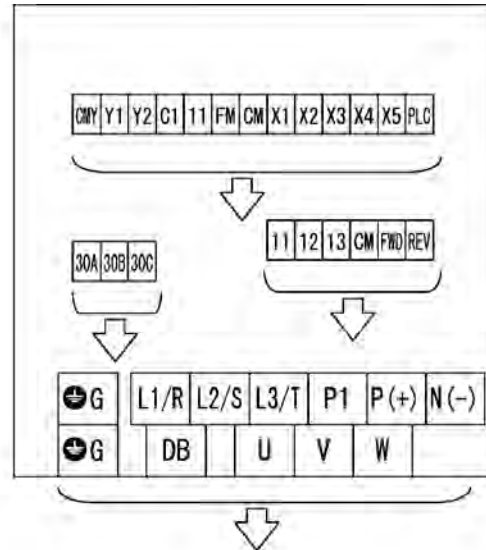

Three-phase 230 V, 2 to 5 HP
Three-phase 460 V, 1/2 to 5 HP

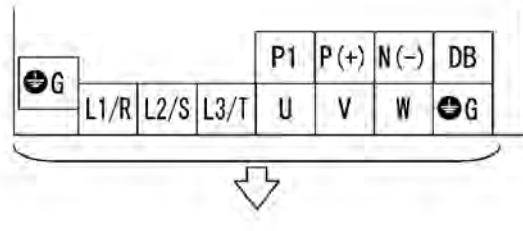

Single-phase 230 V, 1/8 to 1 HP

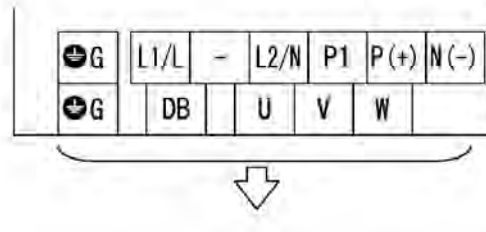

Single-phase 230 V, 2 to 3 HP

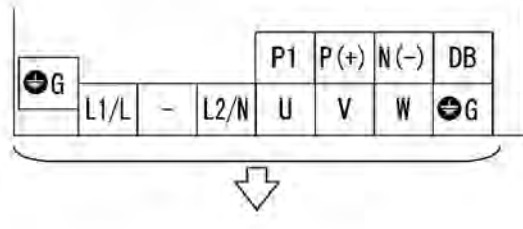

FVR-E11S vs. FRENIC-Multi

FVR-E11S

Three-phase 230 V, 1/8 to 1 HP

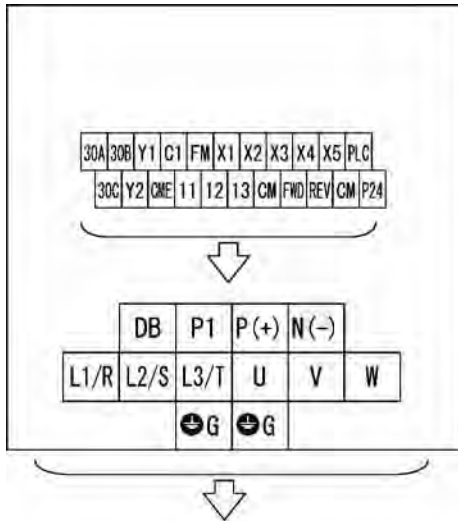

Single-phase 230 V, 1/8 to 1/2 HP

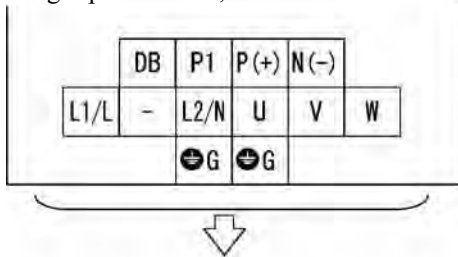

Three-phase 230 V, 2 to 3 HP
Three-phase 460 V, 1/2 to 3 HP

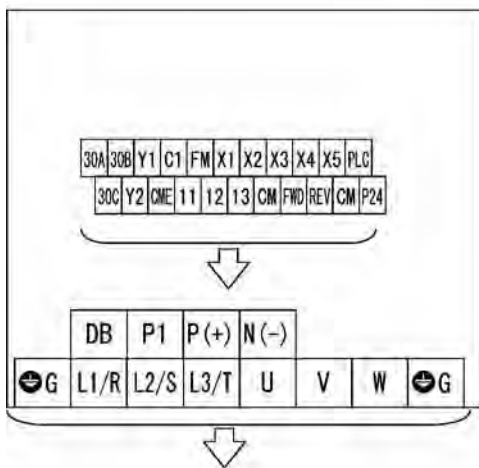

Single-phase 230 V, 1 HP

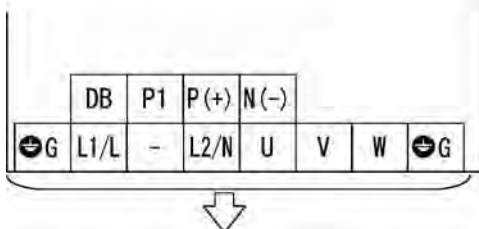

FRENIC-Multi

Three-phase 230 V, 1/8 to 1 HP

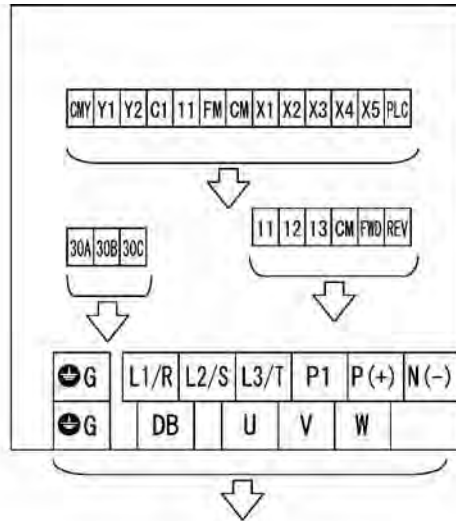

Single-phase 230 V, 1/8 to 1/2 HP

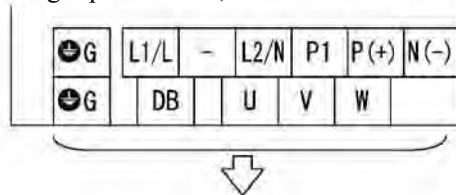

Three-phase 230 V, 2 to 3 HP
Three-phase 460 V, 1/2 to 3 HP

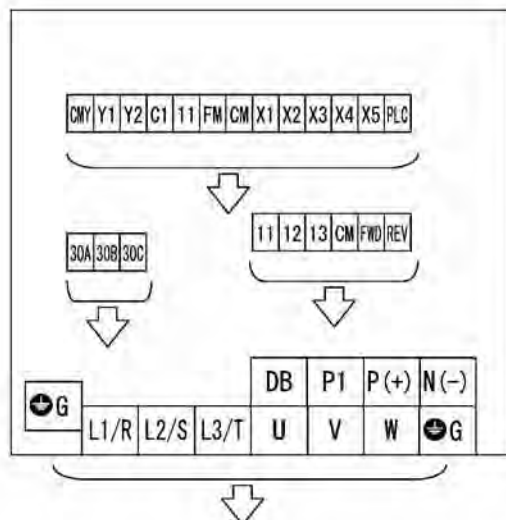

Single-phase 230 V, 1 HP

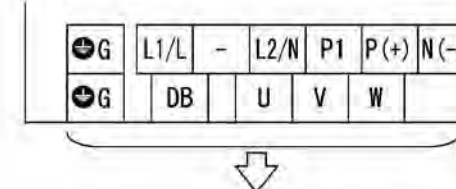

Three-phase 230 V, 5 HP
 Three-phase 460 V, 5 HP

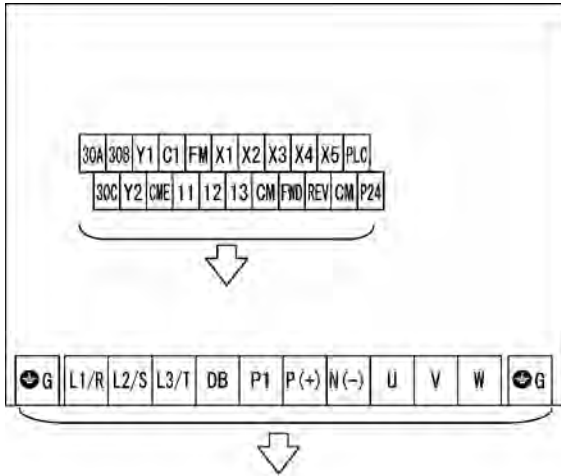

Three-phase 230 V, 5 HP
 Three-phase 460 V, 5 HP

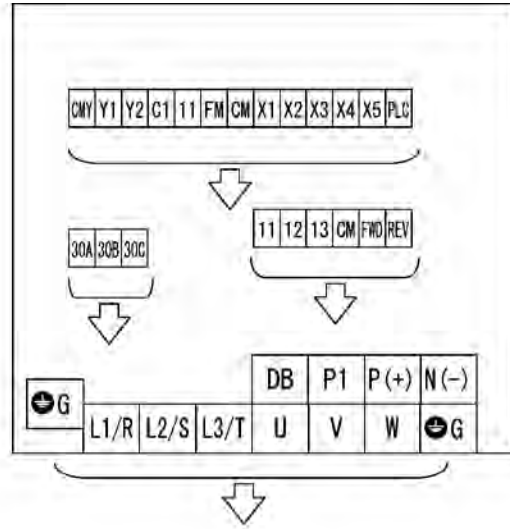

Single-phase 230 V, 2 to 3 HP

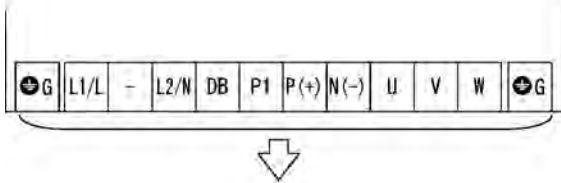

Single-phase 230 V, 2 to 3 HP

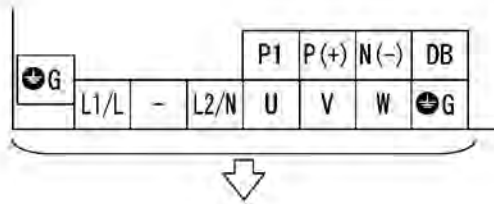

Three-phase 230 V, 7.5 to 10 HP
 Three-phase 460 V, 7.5 to 10 HP

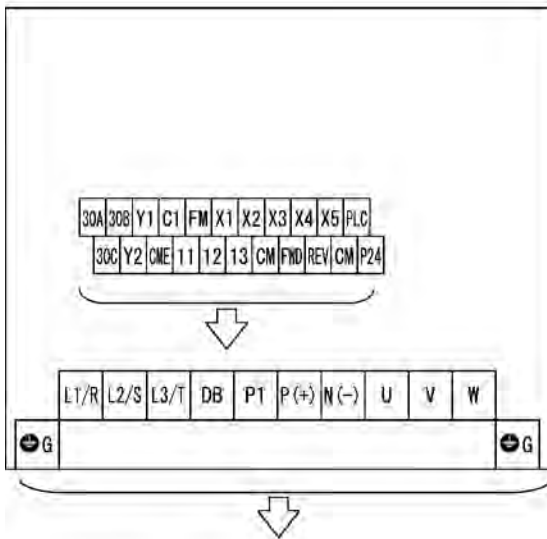

Three-phase 230 V, 7.5 to 10 HP
 Three-phase 460 V, 7.5 to 10 HP

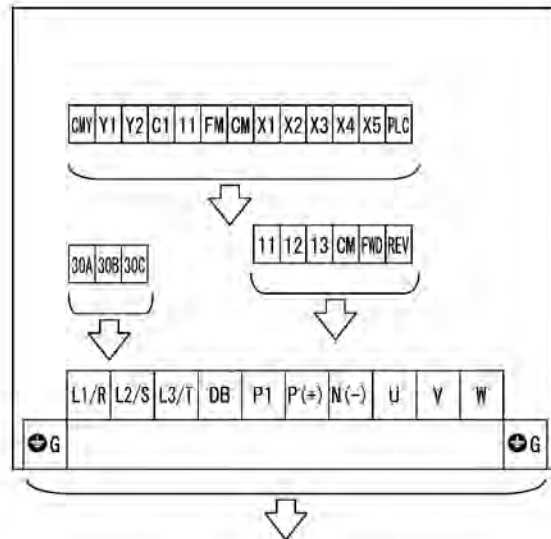

↓ : Direction of wire guide

F.3 Function codes

This section describes the replacement information related to function codes that are required when replacing the conventional inverter series (e.g., FVR-E9S and FVR-E11S) with the FRENIC-Multi series. It also provides the conversion table for the torque boost setting.

FVR-E9S vs. FRENIC-Multi



F: Fundamental functions

FVR-E9S			FRENIC-Multi		
Function code	Name	Data setting range	Function code	Name	Data setting range (Equivalent to the setting for FVR-E9S)
F00	Data protection	0: The data can be changed. 1: The data cannot be changed.	F00	Data protection	0: Disable data protection and digital reference protection 1: Enable data protection and disable digital reference protection
F01	Frequency command 1	0: Setting by keypad panel operation	F01	Frequency command 1	0: UP/DOWN keys on keypad
		1: Setting by voltage and current input	F01	Frequency command 1	3: Sum of voltage and current inputs to terminals [12] and [C1] (C1 function)
F02	Operation method	0: Keypad operation (Motor rotational direction specified by terminal command FWD/REV)	F02	Operation method	0: RUN/STOP keys on keypad (Motor rotational direction specified by terminal command FWD/REV)
		1: Operation by external input			1: Terminal command FWD or REV (digital input)
F03	Maximum frequency 1	50 to 400 Hz	F03	Maximum frequency 1	50.0 to 400.0 Hz
F04	Base frequency 1	50 to 400 Hz	F04	Base frequency 1	50.0 to 400.0 Hz
F05	Rated voltage 1	0V: The output voltage in proportion to the power supply voltage is set. 230 V: 0, 80 to 240 V 460 V: 0, 320 to 480 V	F05	Rated voltage at base frequency 1	0 V: Output a voltage in proportion to input voltage 80 to 240 V for 230 V 160 to 480 V for 460 V
			F06	Maximum output voltage 1	80 to 240 V for 230 V 160 to 480 V for 460 V If F05 ≠ 0, set the same voltage as F05 data. If F05 = 0, you can set an arbitrary value.
F06	Acceleration time 1	0.01 to 3600 s	F07	Acceleration time 1	0.01 to 3600s
F07	Deceleration time 1	0.01 to 3600 s	F08	Deceleration time 1	0.01 to 3600s
F08	Torque boost 1	0: Automatic torque boost	F37	Load selection/ Auto torque boost/ Auto energy saving operation 1	1: Constant torque load
			F09	Torque boost 1	0%
		1: Variable torque load	F37	Load selection/ Auto torque boost/ Auto energy saving operation 1	0: Variable torque load
			-	-	-
2: Proportional torque load	3 to 31: Constant torque load	F09	Torque boost 1	Refer to the Torque Boost Conversion Table on the last page of this appendix for setting torque boost.	
		H50	Non-linear V/f pattern 1 (Frequency)		
		H51	Non-linear V/f pattern 1 (Voltage)		

FVR-E9S			FRENIC-Multi		
Function code	Name	Data setting range	Function code	Name	Data setting range (Equivalent to the setting for FVR-E9S)
F09	FMA voltage output adjustment	0 to 99	F30	Analog output [FM] (Voltage adjustment)	65 to 103% (= 65 + (103 - 65) / 99 x FVR-E9S's data)
F10	No. of poles of motor	2 to 12 (even)	P01	Motor 1 (No. of poles)	2 to 22 (even)
F11	Coefficient for speed indication	0.01 to 200.0	E50	Coefficient for speed indication	0.01 to 200.00
F12	Motor sound adjustment (Carrier frequency)	0, 1 to 15 kHz	F26	Motor sound (Carrier frequency)	0.75, 1 to 15 kHz
F13	Times of auto-reset	0 to 10	H04	Auto-reset (Times)	0 to 10
F14	Restart mode after momentary power failure	0: Inactive (Trip and alarm when power failure occurs) 1: Inactive (Trip, and alarm when power recovers.) 2: Active (Restarts at output frequency of before power failure. 3: Active (Restarts at starting frequency.)	F14	Restart mode after momentary power failure (Mode selection)	0: Disable restart (Trip immediately) 1: Disable restart (Trip after a recovery from power failure) 4: Enable restart (Restart at the frequency at which the power failure occurred, for general loads) 5: Enable restart (Restart at the starting frequency, for low-inertia load)
F15	Electronic thermal overload relay for motor 1 (Select)	0: Inactive	F11	Electronic thermal overload protection for motor 1 (Overload detection level)	0.00
		1: Active (for 4-pole standard motor)	F10	Electronic thermal overload protection for motor 1 (Select motor characteristics)	1: For general-purpose motors with shaft driven fan
		2: Active (for 4-pole inverter motor)			2: For inverter-driven motors, non-ventilated motors, or motors with forced-cooling fan
F16	Electronic thermal overload relay for motor 1 (Level)	0.01 to 99.9	F11	Electronic thermal overload protection for motor 1 (Overload detection level)	0.00: Disable 1 to 135% of the rated current (allowable continuous drive current) of the motor
F17	DC brake (Mode)	0: Disable 1: Enable	F22	DC braking 1 (Braking time)	0.00: Disable 0.01 to 30.00 s
F18	DC brake Starting frequency	0 to 60 Hz	F20	DC braking 1 (Braking starting frequency)	0.0 to 60.0 Hz
F19	DC brake (Braking level)	0 to 100%	F21	DC braking 1 (Braking level)	0 to 100%
F20	DC brake (Braking time)	0.00 to 30.00 s	F22	DC braking 1 (Braking time)	0.00 to 30.00 s
F21	Multi-frequency	0.00 to 400.0 Hz	C05	Multi-frequency	0.00 to 400.00 Hz
F22	1		C06	1	
F23	2		C07	2	
F24	3		C08	3	
F25	4		C09	4	
F26	5		C10	5	
F27	6		C11	6	
F28	7			7	
F28	S-curve acceleration/deceleration pattern	0: Liner 1: S-curve (Weak) 2: S-curve (Strong)	H07	Acceleration/deceleration pattern	0: Liner 1: S-curve (Weak) 2: S-curve (Strong)

App.

FVR-E9S			FRENIC-Multi		
Function code	Name	Data setting range	Function code	Name	Data setting range (Equivalent to the setting for FVR-E9S)
F29	Protective action history	Display alarm history of last four alarms	-	-	Refer to "Menu #6."
F30	Starting frequency	0,1 to 15 Hz	F23	Starting frequency 1	0.2, 1.0 to 15.0 Hz
F31	Torque limiter (During acceleration/ deceleration)	0: No limit Active: 20 to 180%	F40	Torque limiter 1 (Limiting level for driving)	20 to 180% 999: Disable
			F41	Torque limiter 1 (Limiting level for braking)	20 to 180% 999: Disable
			E05	Terminal [X5] function	14: Select torque limiter level (TL2/TL1)
			E16	Torque limiter 2 (Limiting level for driving)	20 to 200% 999: Disable
			E17	Torque limiter 2 (Limiting level for braking)	20 to 200% 999: Disable
			E21	Terminal [Y2] function	21: Frequency arrival signal 2 (FAR2) Note: Short-circuit between terminals [X5] and [Y2] and between CM and CME.
F32	Torque limiter (During constant speed)	0: No limit Active: 20 to 180%	F40	Torque limiter 1 (Limiting level for driving)	20 to 180% 999: Disable
			F41	Torque limiter 1 (Limiting level for braking)	20 to 180% 999: Disable
			E05	Terminal [X5] function	14: Select torque limiter level (TL2/TL1)
			E16	Torque limiter 2 (Limiting level for driving)	20 to 200% 999: Disable
			E17	Torque limiter 2 (Limiting level for braking)	20 to 200% 999: Disable
			E21	Terminal [Y2] function	21: Frequency arrival signal 2 (FAR2) Note: Short-circuit between terminals [X5] and [Y2] and between CM and CME.
F33	Braking torque	0: Braking torque (Low) 1: Braking torque (High)	-	-	-
F34	Bias frequency	-400 to 400 Hz	F18	Bias (Frequency command 1)	-100.0 to 100.0% (FVR-E9S's data x 100 / Maximum frequency 1 (F03))
F35	Gain (For frequency setting signal)	0.00 to 250%	C32	Analog input adjustment for [12] (Gain)	0.00 to 200.00 %
F36	Frequency limiter (High)	0 to 400 Hz	F15	Frequency limiter (High)	0.0 to 400.0 Hz
F37	Frequency limiter (Low)	0 to 400 Hz	F16	Frequency limiter (Low)	0.0 to 400.0 Hz
F38	Motor characteristics	0 to 10	H80	Output current fluctuation damping gain for motor 1	0.00 to 0.40 (Usually, no change is necessary.)
F39	Data initialization	0: Disable initialization 1: Initialize all function code data to the factory defaults	H03	Data initialization	0: Disable initialization 1: Initialize all function code data to the factory defaults
F40	FMA and FMP terminals (Select)	0: Analog output (FMA) 1: Pulse output (FMP)	F29	Analog output [FM] (Mode selection)	0: Output in voltage (0 to 10 VDC) (FMA) 2: Output in pulse (FMP)

FVR-E9S			FRENIC-Multi		
Function code	Name	Data setting range	Function code	Name	Data setting range (Equivalent to the setting for FVR-E9S)
F41	FMA terminal (Function)	0: Output frequency 1: Output current 2: Output torque 3: Load factor	F31	Analog output [FM] (Function)	0: Output frequency 1 (before slip compensation) 2: Output current 4: Output torque 5: Load factor
F42	FMP terminal (Pulse rate amplifier)	10 to 100	F33	Analog output [FM] (Pulse rate)	25 to 6000 p/s (Pulse rate at 100% output) (Maximum frequency setting x FVR-E9S's data)
F43	Terminal X4 (Function)	0: RT1 function 1: Terminal X4 function 2: VF2 function 3: HLD function	E04	Terminal [X4] function	4: Select ACC/DEC time (RT1) 3: Select multi-frequency (SS8) 12: Select motor 2/motor 1 (M2/M1) 6: Enable 3-wire operation (HLD)
F44 F45 F46 F47 F48 F49 F50 F51	Multi-frequency 8 to 15	0.00 to 400 Hz	C12 C13 C14 C15 C16 C17 C18 C19	Multi-frequency 8 to 15	0.00 to 400.00 Hz
F52	Frequency command filter	0.02 to 5.00 s	C33	Analog Input adjustment for [12] (Filter time constant)	0.02 to 5.00 s
			C38	Analog Input adjustment for [C1] (Filter time constant)	0.02 to 5.00 s
F53	Timer operation time	0: Disable 1: 0.01 to 3600 s	C21	Timer operation	0: Disable 1: Enable (The time can be specified within the range from 1 to 3600 s in units of 1 s with the  and  keys on the keypad.)
F54	Terminal Y1	0: Inverter running (RUN) 1: Frequency level detection (FDT) 2: Frequency equivalence signal (FAR) 3: Undervoltage detection signal (LU) 4: Torque limiting (TL) 5: Auto-restarting	E20	Terminal [Y1] function	0: Inverter running (RUN) 2: Frequency detected (FDT) 1: Frequency arrival signal (FAR) 3: Undervoltage detected (Inverter stopped) (LU) 5: Inverter output limiting (IOL) 6: Auto-restarting after momentary power failure (IPF)
F55	FDT function signal (Level)	0 to 400.0 Hz	E31	Frequency Detection (FDT) (Detection level)	0.0 to 400.0 Hz
F56	FDT function signal (Hysteresis)	0 to 30 Hz	E30	Frequency Arrival (Hysteresis width)	0.0 to 10.0 Hz
			E32	Frequency Detection (FDT) (Hysteresis width)	0.0 to 400.0 Hz
F57	Terminal THR (Function)	0: THR function 1: Write enable for keypad	E05	Terminal [X5] function	9: (1009) Enable external alarm trip (THR) 19: (1019) Enable data change with keypad (WE-KP)

App.

FVR-E9S			FRENIC-Multi		
Function code	Name	Data setting range	Function code	Name	Data setting range (Equivalent to the setting for FVR-E9S)
F58	Jump frequency (Hysteresis)	0 to 30 Hz	C04	Jump frequency (Hysteresis)	0.0 to 30.0 Hz
F59	Jump frequency 1	0 to 400 Hz	C01	Jump frequency 1	0.00 to 400.0 Hz
F60	Jump frequency 2	0 to 400 Hz	C02	Jump frequency 2	0.00 to 400.0 Hz
F61	Jump frequency 3	0 to 400 Hz	C03	Jump frequency 3	0.00 to 400.0 Hz
F62	Base frequency 2	50 to 400 Hz	A02	Base frequency 2	50.0 to 400.0 Hz
F63	Acceleration time 2	0.01 to 3600 s	E10	Acceleration time 2	0.01 to 3600 s
F64	Deceleration time 2	0.01 to 3600 s	E11	Deceleration time 2	0.01 to 3600 s
F65	Torque Boost 2	1: Variable torque load	F09	Torque boost 1	0.0 to 20.0%
			A13	Load selection/ Auto torque boost/ Auto energy saving operation 2	0: Variable torque load
		2: Proportional torque load	-	-	-
		3 to 31: Constant torque load	F09	Torque boost 1	Refer to the "Torque Boost Conversion Table" on the last page of this appendix.
F66	Electronic thermal overload relay 2 (Select)	0: Inactive	A07	Electronic thermal overload protection for motor 2 (Overload detection level)	0.00
		1: Active (for 4-pole standard motor)	A06	Electronic thermal overload protection for motor 2 (Select motor characteristics)	1: For general-purpose motors with shaft driven fan
		2: Active (for 4-pole inverter motor)			2: For inverter-driven motors, non-ventilated motors, or motors with forced-cooling fan
F67	Electronic thermal overload relay 2 (Level)	0.01 to 99.9	A07	Electronic thermal overload protection for motor 2 (Overload detection level)	0.00: Disable 1 to 135% of the rated current (allowable continuous drive current) of the motor
F68	Slip compensation	0.0 to 5.0 Hz	P09	Motor 1 (Slip compensation gain for driving)	100.0%
			P11	Motor 1 (Slip compensation gain for braking)	100.0%
			P12	Motor 1 (Rated slip frequency)	0.00 to 5.00 Hz
F69	Torque vector control	0: Inactive 1: Active	F42	Control mode selection 1	0: Disable (V/f operation with slip compensation inactive) 1: Enable (Dynamic torque vector operation)

FVR-E9S			FRENIC-Multi		
Function code	Name	Data setting range	Function code	Name	Data setting range (Equivalent to the setting for FVR-E9S)
F70	Motor capacity	0: With 1 rank higher capacity 1: With same rank 2: With 1 rank lower capacity 3: With 2 ranks lower capacity	P02	Motor 1 (Rated capacity)	0.01 to 11.00 kW
F71	Motor 1 Rated current	0.00 to 99.9 A	P03	Motor 1 (Rated current)	0.00 to 100.0 A
F72	Motor 1 No-load current	0.00 to 99.9 A	P06	Motor 1 (No-load current)	0.00 to 50.00 A
F73	Motor 2 Rated current	0.00 to 99.9 A	A17	Motor 2 (Rated current)	0.00 to 100.0 A
F74	Tuning	0: Inactive 1: Active	A18	Motor 2 (Auto-tuning)	0: Disable 1: Enable (Tune %R1 and %X while the motor is stopped.)
F75	Motor 1 %R1	0.00 to 50.00%	P07	Motor 1 (%R1)	0.00 to 50.00%
F76	Motor 1 %X	0.00 to 50.00%	P08	Motor 1 (%X)	0.00 to 50.00%
F77	Torque limit response (At constant speed)	0 to 999	-	-	-
F78	Torque limit response (At acceleration/ deceleration)	0 to 999	-	-	-

FVR-E11S vs. FRENIC-Multi

F: Fundamental functions

FVR-E11S		FRENIC-Multi					
Function code	Name	Data setting range		Function code	Name	Data setting range (Equivalent to the setting for FVR-E11S)	
F00	Data protection	0: Data change enable 1: Data protection		F00	Data protection	0: Disable data protection and digital reference protection 1: Enable data protection and disable digital reference protection	
F01	Frequency command 1	0: Keypad operation (UP/DOWN keys)		F01	Frequency command 1	0: UP/DOWN keys on keypad	
		1: Voltage input (Terminal [12])		F01	Frequency command 1	1: Voltage input to terminal [12]	
				C35	Analog Input adjustment for [12] (Polarity)	1: Unipolar	
		2: Current input (Terminal [C1])		F01	Frequency command 1	2: Current input to terminal [C1] (C1 function)	
		3: Voltage and current input		F01	Frequency command 1	3: Sum of voltage and current inputs to terminals [12] and [C1] (C1 function)	
		4: Reversible operation with polarity (Terminal [12])		F01	Frequency command 1	1: Voltage input to terminal [12]	
				C35	Analog Input adjustment for [12] (Polarity)	0: Bipolar	
		5: Inverse mode operation with polarity (Terminal [12])		F01	Frequency command 1	1: Voltage input to terminal [12]	
				C53	Selection of normal/inverse operation	1: Inverse operation	
		6: Inverse mode operation (Terminal [C1])		F01	Frequency command 1	2: Current input to terminal [C1] (C1 function)	
				C53	Selection of normal/inverse operation	1: Inverse operation	
		7: UP/DOWN control 1		F01	Frequency command 1	7: Terminal command UP/DOWN control	
				H61	UP/DOWN control (Initial frequency setting)	0: 0.00	
		8: UP/DOWN control 2		F01	Frequency command 1	7: Terminal command UP/DOWN control	
H61	UP/DOWN control (Initial frequency setting)			1: Last UP/DOWN command value on releasing run command			
F02	Operation method	0: Keypad operation (Motor rotational direction specified by terminals [FWD] / [REV]) 1: External signal input (digital input) 2: Keypad operation (Run to forward) 3: Keypad operation (Run to reverse)		F02	Operation method	0: RUN/STOP keys on keypad (Motor rotational direction specified by terminal command FWD/REV)	
						1: Terminal command FWD or REV	
						2: RUN/STOP keys on keypad (forward)	
						3: RUN/STOP keys on keypad (reverse)	
F03	Maximum frequency 1	50 to 400 Hz		F03	Maximum frequency	50.0 to 400.0 Hz	
F04	Base frequency 1	25 to 400 Hz		F04	Base frequency 1	25.0 to 400.0 Hz	
F05	Rated voltage 1	0 V: The output voltage in proportion to the power supply voltage is set. 230 V: 80 to 240 V 460 V: 160 to 480 V		F05	Rated voltage at base frequency 1	0 V: Output a voltage in proportion to input voltage	
						80 to 240 V for 230 V 160 to 480 V for 460 V	
F06	Maximum voltage 1	230 V: 80 to 240 V		F06	Maximum output voltage 1	80 to 240 V for 230 V	
		460 V: 160 to 480 V				160 to 480 V for 460 V	
F07	Acceleration time 1	0.01 to 3600 s		F07	Acceleration time 1	0.01 to 3600 s	
F08	Deceleration time 1	0.01 to 3600 s		F08	Deceleration time 1	0.01 to 3600 s	

FVR-E11S				FRENIC-Multi			
Function code	Name	Data setting range		Function code	Name	Data setting range (Equivalent to the setting for FVR-E11S)	
F09	Torque boost 1	0: Automatic torque boost		F37	Load selection/ Auto torque boost/ Auto energy saving operation 1	1: Constant torque load	
		1: Variable torque characteristics		F09	Torque boost 1	0%	
				F37	Load selection/ Auto torque boost/ Auto energy saving operation 1	0: Variable torque load	
		2: Proportional torque		There is no pattern equivalent to the FVR-E11S's proportional torque. Selecting the constant torque is recommended.			
		3 to 31: Constant torque		F09	Torque boost 1	Refer to the "Torque Boost Conversion Table" on the last page of this appendix.	
				H50	Non-linear V/f pattern (Frequency)		
				H51	Non-linear V/f pattern (Voltage)		
F10	Electronic thermal O/L relay for motor 1 (Select)	0: Inactive		F11	Electronic thermal overload protection for motor 1 (Overload detection level)	0.00	
		1: Active (for standard motor) 2: Active (for inverter motor)		F10	Electronic thermal overload protection for motor 1 (Select motor characteristics)	1: For a general-purpose motor with shaft driven fan 2: For an inverter-driven motor, non-ventilated motor, or motor with forced-cooling fan	
F11	Electronic thermal O/L relay for motor 1 (Level)	20 to 135% of the rated current of the inverter.		F11	Electronic thermal overload protection for motor 1 (Overload detection level)	20 to 135%	
F12	Electronic thermal O/L relay for motor 1 (Thermal time constant)	0.5 to 10 min		F12	Electronic thermal overload protection for motor 1 (Thermal time constant)	0.5 to 10.0 min	
F13	Electronic thermal O/L relay (for braking resistor)	Data	230 V	460 V	F50	Electronic thermal overload protection for braking resistor (Discharging capability)	
		0	Inactive	Inactive			999: Disable
		1	Active (External braking resistor: DB□□-2C)	Active (External braking resistor: DB□□-4C)			Functionally equivalent to the FVR-E11S's function code. However, the setting procedure is different, so make the setting appropriate for the applied braking resistor.
2	Active External braking resistor: TK80W or External braking resistor: DB□□-2C	Active (External braking resistor: DB□□-4C)	F50 F51 Electronic thermal overload protection for braking resistor (Discharging capability) (Allowable average loss)				

App.

FVR-E11S			FRENIC-Multi		
Function code	Name	Data setting range	Function code	Name	Data setting range (Equivalent to the setting for FVR-E11S)
F14	Restart mode after momentary power failure (Select)	0: Inactive (immediate inverter trip) 1: Inactive (inverter trip at recovery) 3: Active (Restart at the frequency at which the power failure occurred) 4: Active (Restart at the starting frequency)	F14	Restart mode after momentary power failure	0: Disable restart (Trip immediately) 1: Disable restart (Trip after a recovery from power failure) 4: Enable restart (Restart at the frequency at which the power failure occurred, for general loads) 5: Enable restart (Restart at the starting frequency, for low-inertia load)
F15	Frequency limiter (High)	0 to 400 Hz	F15	Frequency limiter (High)	0.0 to 400.0 Hz
F16	(Low)		F16	(Low)	
F17	Gain (for frequency setting signal)	0.0 to 200.0%	C32 C37	Analog input adjustment for [12] (Gain) Analog input adjustment for [C1] (Gain)	0.00 to 200.00%
F18	Bias frequency	-400 to +400 Hz	F18	Bias (Frequency command 1)	Bias frequency x 100 / maximum frequency
F20	DC break (Starting freq.)	0.0 to 60.0 Hz	F20	DC braking 1 (Braking starting frequency)	0.0 to 60.0 Hz
F21	(Braking level)	0 to 100%	F21	(Braking level)	0 to 100%
F22	(Braking time)	0.0 s (DC brake inactive) 0.1 to 30.0 s	F22	(Braking time)	0.00: Disable 0.1 to 30.00 s
F23	Starting frequency (Freq.)	0.1 to 60.0 Hz	F23	Starting frequency 1	0.1 to 60.0 Hz
F24	(Holding time)	0.0 to 10.0 s	F24	(Holding time)	0.00 to 10.00 s
F25	Stop frequency	0.1 to 6.0 Hz	F25	Stop frequency	0.1 to 60.0 Hz
F26	Motor sound (Carrier freq.)	0.75, 1 to 15 kHz	F26	Motor Sound (Carrier frequency)	0.75, 1 to 15 kHz
F27	(Sound tone)	0 to 3	F27	(Tone)	0 to 3
F29	FMA and FMP terminals (Select)	0: Analog output (FMA function) 1: Pulse output (FMP function)	F29	Analog output [FM] (Mode selection)	0: Output in voltage (0 to 10 VDC) (FMA) 2: Output in pulse (0 to 6000 p/s) (FMP)
F30	FMA (Voltage adjust)	0 to 200%	F30	Analog output [FM] (Voltage adjustment)	0 to 200% (FMA)
F31	(Function)	0: Output frequency 1 (before slip compensation) 1: Output frequency 2 (after slip compensation) 2: Output current 3: Output voltage 4: Output torque 5: Load factor 6: Input power 7: PID feedback value 8: DC link circuit voltage	F31	(Function)	0: Output frequency 1 (before slip compensation) 1: Output frequency 2 (after slip compensation) 2: Output current 3: Output voltage 4: Output torque 5: Load factor 6: Input power 7: PID feedback amount (PV) 9: DC link bus voltage
F33	FMP terminal (Pulse rate)	300 to 6000 p/s (at full scale)	F33	Analog output [FM] (Pulse rate)	300 to 6000 p/s (FMP , Pulse rate at 100% output)
F34	(Voltage adjust)	0%	F29	Analog output [FM] (Mode selection)	2: Output in pulse (0 to 6000 p/s) (FMP)
		1 to 200%	F29	Analog output [FM] (Mode selection)	0: Output in voltage (0 to 10 VDC) (FMA)
			F30	Analog output [FM] (Voltage adjustment)	1 to 200% (FMA)
F35	(Function)	0 to 8 (as same as those of F31)	F31	(Function)	0 to 9



FVR-E11S			FRENIC-Multi		
Function code	Name	Data setting range	Function code	Name	Data setting range (Equivalent to the setting for FVR-E11S)
F36	30Ry operation mode	0: The relay (30) excites on trip mode 1: The relay (30) excites on normal mode	E27	Terminal [30A/B/C] function	99: Alarm output (for any alarm) (Active ON) 1099: Alarm output (for any alarm) (Active OFF)
F40	Torque limiter 1 (Driving)	20 to 200% 999: No limit	F40	Torque limiter 1 (Limiting level for driving)	20 to 200% 999: Disable
F41	(Braking)	0%: Automatic deceleration control 20 to 200% 999: No limit	F41	(Limiting level for braking)	20 to 200% 999: Disable
F42	Torque vector control 1	0: Inactive 1: Active	F42	Control mode selection 1	0: Disable (V/f operation with slip compensation inactive) 1: Enable (Dynamic torque vector operation)

E: Extension terminal functions

FVR-E11S			FRENIC-Multi		
Function code	Name	Data setting range	Function code	Name	Data setting range (Equivalent to the setting for FVR-E11S)
E01	X1 terminal function	0: Multistep freq. select (SS1) 1: Multistep freq. select (SS2) 2: Multistep freq. select (SS4) 3: Multistep freq. select (SS8) 4: ACC/DEC time selection (RT1)	E01	Terminal [X1] function	0: Select multi-frequency (SS1) 1: Select multi-frequency (SS2) 2: Select multi-frequency (SS4) 3: Select multi-frequency (SS8) 4: Select ACC/DEC time (RT1)
E02	X2 terminal function	5: 3-wire operation stop command (HLD) 6: Coast-to-stop command (BX) 7: Alarm reset (RST) 8: Trip command (external fault) (THR) 9: Freq. set. 2/Freq. set. (H2/Hz1)	E02	Terminal [X2] function	6: Enable 3-wire operation (HLD) 7: Coast to a stop (BX) 8: Reset alarm (RST) 9: Enable external alarm trip (THR) 11: Select frequency command 2/1 (H2/Hz1)
E03	X3 terminal function	10: Motor 2/Motor 1 (M2/M1) 11: DC brake command (DCBRK) 12: Torque limiter 2/Torque limiter 1 (TL2/TL1) 13: UP command (UP) 14: DOWN command (DOWN)	E03	Terminal [X3] function	12: Select motor 2/motor 1 (M2/M1) 13: Enable DC braking (DCBRK) 14: Select torque limiter level (TL2/TL1) 17: UP (Increase output frequency) (UP) 18: DOWN (Decrease output frequency) (DOWN)
E04	X4 terminal function	15: Write enable for keypad (WE-KP) 16: PID control cancel (Hz/PID) 17: Inverse mode changeover (IVS) 18: Link enable (LE)	E04	Terminal [X4] function	19: Enable data change with keypad (WE-KP) 20: Cancel PID control (Hz/PID) 21: Switch normal/inverse operation (IVS)
E05	X5 terminal function		E05	Terminal [X5] function	24: Enable communications link via RS-485 or field bus (LE) (RS-485: standard, Bus: option) 25: Universal DI (U-DI)
E10	Acceleration time 2	0.01 to 3600 s	E10	Acceleration time 2	0.01 to 3600 s
E11	Deceleration time 2		E11	Deceleration time 2	
E16	Torque limiter 2 (Driving)	20 to 200% 999: No limit	E16	Torque limiter 2 (Limiting level for driving)	20 to 200% 999: Disable
E17	(Braking)	0%: Automatic deceleration control	H69	Automatic deceleration (Mode selection)	0: Disable
		20 to 200% 999: No limit	E17	Torque limiter 2 (Limiting level for braking)	20 to 200% 999: Disable
E20	Y1 terminal function (Function)	0: Inverter running (RUN) 1: Frequency equivalence signal (FAR) 2: Frequency level detection (FDT) 3: Undervoltage detection signal (LU) 4: Torque polarity (B/D) 5: Torque limiting (TL) 6: Auto-resetting (IPF)	E20	Terminal [Y1] function	0: Inverter running (RUN) 1: Frequency arrival signal (FAR) 2: Frequency detected (FDT) 3: Undervoltage detected (Inverter stopped) (LU) 4: Torque polarity detected (D/B) 5: Inverter output limiting (IOL)
E21	Y2 terminal function	7: Overload early warning (OL) 8: Lifetime alarm (main circuit capacitor) (LIFE) 9: 2nd frequency equivalence detection (FAR2)	E21	Terminal [Y2] function	6: Auto-restarting after momentary power failure (IPF) 7: Motor overload early warning (OL) 30: Service life alarm (LIFE) 21: Frequency arrival signal 2 (FAR2)
E29	Frequency equivalence delay	0.01 to 10.0 s	E29	Frequency arrival delay time	0.01 to 10.0 s

FVR-E11S			FRENIC-Multi		
Function code	Name	Data setting range	Function code	Name	Data setting range (Equivalent to the setting for FVR-E11S)
E30	FAR function signal (Hysteresis)	0.0 to 10.0 Hz	E30	Frequency arrival (Hysteresis width)	0.0 to 10.0 Hz
E31	FDT function signal (Level)	0 to 400 Hz	E31	Frequency detection (FDT) (Detection level)	0.0 to 400.0 Hz
E32	(Hysteresis)	0.0 to 30.0 Hz	E32	(Hysteresis width)	0.0 to 400.0 Hz
E33	OL1 function signal (Mode select)	0: Electric thermal O/L relay	E20/ E21	Terminal [Y1]/[Y2] function	7: Motor overload early warning (OL)
		1: Output current	E20/ E21	Terminal [Y1]/[Y2] function	37: Current detected (ID)
E34	(Level)	5 to 200% of inverter rated current	E34	Overload early warning/ Current detection (Level)	Current value of 5 to 200% of the inverter rated current
E35	(Timer)	0.00 to 60.0 s	E35	(Timer)	0.01 to 600.00 s
E39	Coefficient for constant feeding rate time	0.000 to 9.999	E39	Coefficient for constant feeding rate time	0.000 to 9.999
E40	Display coefficient A	0.00 to 200.0	E40	PID display coefficient A	0.00 to 200.0
E41	Display coefficient B	0.00 to 200.0	E41	PID display coefficient B	0.00 to 200.0
E42	LED display filter	0.0 to 5.0 s	E42	LED display filter	0.0 to 5.0 s

C: Control functions

FVR-E11S			FRENIC-Multi		
Function code	Name	Data setting range	Function code	Name	Data setting range (Equivalent to the setting for FVR-E11S)
C01	Jump frequency	0 to 400 Hz	C01	Jump frequency	0 to 400 Hz
C02	-----1		C02	-----1	
C03	-----2		C03	-----2	
C04	(Hysteresis)	0 to 30 Hz	C04	(Hysteresis)	0 to 30 Hz
C05	Multistep frequency setting	0.00 to 400.0 Hz	C05	Multi-frequency	0.00 to 400.0 Hz
C06	-----1		C06	-----1	
C07	-----2		C07	-----2	
C08	-----3		C08	-----3	
C09	-----4		C09	-----4	
C10	-----5		C10	-----5	
C11	-----6		C11	-----6	
C12	-----7		C12	-----7	
C13	-----8		C13	-----8	
C14	-----9		C14	-----9	
C15	-----10		C15	-----10	
C16	-----11		C16	-----11	
C17	-----12		C17	-----12	
C18	-----13		C18	-----13	
C19	-----14		C19	-----14	
C21	Timer operation	0: Inactive 1: Active	C21	Timer operation	0: Disable 1: Enable
C22	Pattern operation (Stage 1)	0.00 to 3600 s	-	-	With C21=1, set the time with the  and  keys.
C30	Frequency command 2	0 to 8 (as same as those of F01)	C30	Frequency command 2	Refer to FVR-E11S's F01.
C31	Offset (Terminal [12])	-5.0 to +5.0%	C31	Analog input adjustment for [12] (Offset)	-5.0 to +5.0%
C32	(Terminal [C1])	-5.0 to +5.0%	C36	Analog Input adjustment for [C1] (Offset)	-5.0 to +5.0%
C33	Analog setting signal filter	0.00 to 5.00s	C33	Analog Input adjustment for [12] (Filter time constant)	0.00 to 5.00 s

P: Motor 1 parameters

FVR-E11S			FRENIC-Multi		
Function code	Name	Data setting range	Function code	Name	Data setting range (Equivalent to the setting for FVR-E11S)
P01	Motor 1 (Number of poles)	2 to 14	P01	Motor 1 (No. of poles)	2 to 22
P02	(Capacity)	0.01 to 5.50 kW (3.7 kW or less) 0.01 to 11.0 kW (5.5/7.5 kW)	P02	(Rated capacity)	0.01 to 11.0 kW
P03	(Rated current)	0.00 to 99.9 A	P03	(Rated current)	0.00 to 99.9 A
P04	(Tuning)	0: Inactive 1: Active (%R1 and %X) 2: Active (%R1, %X and lo)	P04	(Auto-tuning)	1: Enable (Tune %R1 and %X while the motor is stopped.) 2: Enable (Tune %R1 and %X while the motor is stopped, and no-load current while running.)
P05	(On-line tuning)	0: Inactive 1: Active	P05	(Online tuning)	0: Disable 1: Enable
P06	(No-load current)	0.00 to 99.9 A	P06	(No-load current)	0.00 to 50.00 A
P07	(%R1 setting)	0.00 to 50.00%	P07	(%R1)	0.00 to 50.00%
P08	(%X setting)	0.00 to 50.00%	P08	(%X)	0.00 to 50.00%
P09	(Slip compensation control)	0.00 to 15.00 Hz	P12	(Rated slip frequency)	0.00 to 15.00 Hz (Set P09 and P11 data to 100%.)
P10	(Slip compensation response time)	0.01 to 10.00 s	P10	(Slip compensation response time)	0.01 to 10.00 s

H: High performance functions

FVR-E11S			FRENIC-Multi		
Function code	Name	Data setting range	Function code	Name	Data setting range (Equivalent to the setting for FVR-E11S)
H01	Accumulated operation time	LED monitor shows the accumulated operation time.	—	—	Check with Menu #5_00 (cumulative run time).
H02	Trip history	LED monitor shows the trip history.	—	—	Check with Menu #6_00 (output frequency).
H03	Data initializing	0: Disabled 1: Initializing data	H03	Data initialization	0: Disable initialization 1: Initialize all function code data to the factory defaults
H04	Auto-reset (Times)	0: (Inactive), 1 to 10 times	H04	Auto-reset (Times)	0: Disable 1 to 10
H05	(Reset interval)	2 to 20 s	H05	(Reset interval)	2 to 20 s
H06	Cooling fan ON-OFF control	0: Inactive 1: Active	H06	Cooling fan ON/OFF control	0: Disable 1: Enable
H07	ACC/DEC pattern	0: Liner 1: S-curve (Weak) 2: S-curve (Strong) 3: Non-linear	H07	Acceleration/ deceleration pattern	0: Linear 1: S-curve (Weak) 2: S-curve (Strong) 3: Curvilinear
H09	Start mode (Rotating motor pick up)	0: Inactive 1: Active (Only auto-restart after momentary power failure mode) 2: Active	H09	Starting mode (Auto search)	0: Disable 1: Enable (At restart after momentary power failure) 2: Enable (At restart after momentary power failure and at normal start)
H10	Energy saving operation	0: Inactive	F37	Load selection/ Auto torque boost/ Auto energy saving operation 1	0 or 1 (Refer to F09.)
		1: Active			3: Equivalent to FVR-E11S's F09 being set to 1 or 2 4: Equivalent to FVR-E11S's F09 being set to any of 3 to 31 (Refer to the FVR-E11S's F09.)
H11	DEC mode	0: Normal 1: Coast-to-stop	H11	Deceleration mode	0: Normal deceleration 1: Coast-to-stop
H12	Instantaneous overcurrent limiting	0: Inactive 1: Active	H12	Instantaneous overcurrent limiting	0: Disable 1: Enable
H13	Auto-restart (Restart time)	0.1 to 5.0 s	H13	Restart mode after momentary power failure (Restart time)	0.1 to 5.0 s (when H16 = 999)
H14	(Freq. fall rate)	0.00 to 100.0 Hz/s	H14	(Frequency fall rate)	0.00 to 100.0 Hz/s
H20	PID control (Mode select)	0: Inactive 1: Active 2: Active (inverse operation mode)	J01	PID control (Mode selection)	0: Disable 1: Enable (Process control, normal operation) 2: Enable (Process control, inverse operation)
H21	(Feedback signal)	0: Terminal [12] (0 to 10 VDC)	E61	Terminal [12] extended function	5: PID feedback amount
		1: Terminal [C1] (4 to 20 mA)	E62	Terminal [C1] extended function (C1 function)	5: PID feedback amount
		2: Terminal [12] (10 to 0 VDC)	-	-	-
		3: Terminal [C1] (20 to 4 mA)	-	-	-
H22	P-Gain	0.01 to 10.00 (1 to 1000%)	J03	P (Gain)	0.000 to 10.000
H23	I-Gain	0.0: Inactive 0.1 to 3600 s	J04	I (Integral time)	0.0: Disable 0.1 to 3600.0 s
H24	D-Gain	0.00: Inactive 0.01 to 10.0 s	J05	D (Differential time)	0.00: Disable 0.01 to 10.00 s
H25	(Feedback filter)	0.0 to 60.0 s	J06	(Feedback filter)	0.0 to 60.0 s
H26	PTC thermistor (Mode select)	0: Inactive 1: Active	H26	Thermistor (Mode selection)	0: Disable 1: Enable
H27	(Level)	0.00 to 5.00 V	H27	(Level)	0.00 to 5.00 V
H28	Droop operation	-9.9 to 0.0 Hz	H28	Droop control	-9.9 to 0.0 Hz

App.

FVR-E11S			FRENIC-Multi		
Function code	Name	Data setting range	Function code	Name	Data setting range (Equivalent to the setting for FVR-E11S)
H30	Serial link (Function select) X: Valid -: Invalid	(Code) (Monitor) (Frequency (Operation command) command) 0: X - - 1: X X - 2: X - X 3: X X X	H30	Communications link function (Mode selection) X: Valid -: Invalid	(Code) (Monitor) (Frequency (Run command) command) 0: X - - 1: X X - 2: X - X 3: X X X
H31	RS-485 (Address)	1 to 31	y01	RS-485 Communication (Standard) (Station address)	1 to 31
H32	(Mode select on no response error)	0: Trip and alarm $E-rB$ 1: Operation for H33 timer, and alarm $E-rB$ 2: Operation for H33 timer, and retry to communicate. (If the retry fails, then the inverter trips $E-rB$.) 3: Continuous operation	y02	(Communications error processing)	0: Immediately trip with alarm $E-rB$ 1: Trip with alarm $E-rB$ after running for the period specified by timer y03 2: Retry during the period specified by timer y03. If the retry fails, trip with alarm $E-rB$. If it succeeds, continue to run. 3: Continue to run
H33	(Timer)	0.0 to 60.0 s	y03	(Timer)	0.0 to 60.0 s
H34	(Baud rate)	0: 19200 bit/s 1: 9600 2: 4800 3: 2400 4: 1200	y04	(Baud rate)	3: 19200 bps 2: 9600 1: 4800 0: 2400 -
H35	(Data length)	0: 8 bits 1: 7 bits	y05	(Data length)	0: 8 bits 1: 7 bits
H36	(Parity check)	0: No check 1: Even parity 2: Odd parity	y06	(Parity check)	0: None 1: Even parity 2: Odd parity
H37	(Stop bits)	0: 1 bit 1: 2 bits	y07	(Stop bits)	1: 1 bit 0: 2 bits
H38	No response error detection time)	0: No detection 1 to 60 s	y08	(No-response error detection time)	0: No detection 1 to 60 s
H39	(Response interval)	0.00 to 1.00 s	y09	(Response interval)	0.00 to 1.00 s
H40	Maximum temperature of heat sink	Data is displayed on the LED monitor of the keypad.	-	Maximum temperature of heat sink	Refer to Menu #5_03
H41	Maximum effective current	Data is displayed on the LED monitor of the keypad.	-	Maximum effective output current	Refer to Menu #5_04
H42	Main circuit capacitor lifetime	Data is displayed on the LED monitor of the keypad.	-	Lifetime of DC link bus capacitor	Refer to Menu #5_05
H43	Cooling fan accumulated operation time	Data is displayed on the LED monitor of the keypad.	-	Cumulative run time of cooling fan	Refer to Menu #5_07
H44	Inverter ROM version	Data is displayed on the LED monitor of the keypad.	-	Inverter ROM version	Refer to Menu #5_14
H45	Keypad panel ROM version	Data is displayed on the LED monitor of the keypad.	-	Keypad panel ROM version	Refer to Menu #5_16
H46	Option ROM version	Data is displayed on the LED monitor of the keypad.	-	Option ROM version	Refer to Menu #5_19

A: Alternative motor parameters 2

FVR-E11S			FRENIC-Multi		
Function code	Name	Data setting range	Function code	Name	Data setting range (Equivalent to the setting for FVR-E11S)
A01	Maximum frequency 2	50 to 400 Hz	A01	Maximum frequency 2	50 to 400 Hz
A02	Base frequency 2	25 to 400 Hz	A02	Base Frequency 2	25 to 400 Hz
A03	Rated voltage 2	0V: The output voltage in proportion to the power supply voltage is set.	A03	Rated voltage at base frequency 2	0V: Output a voltage in proportion to input voltage
		200 V: 80 to 240 V			
A04	Maximum voltage 2	230 V: 80 to 240 V	A04	Maximum output voltage 2	160 to 480 V for 460 V
		460 V: 160 to 480 V			
A05	Torque boost 2	0,1,2,3 to 31	A05	Torque boost 2	Refer to the "Torque Boost Conversion Table" on the last page of this appendix.
A06	Electric thermal overload relay for motor 2 (Select)	0: Inactive	A07	Electronic thermal overload protection for motor 2 (Overload detection level)	0.00: Disable
		1: Active (for 4-pole standard motor) 2: Active (for 4-pole inverter motor)			1: For general-purpose motors with shaft driven fan 2: For inverter-driven motors, non-ventilated motors, or motors with forced-cooling fan
A07	Electric thermal overload relay for motor 2 (Level)	20 to 135% of the inverter rated current, in Ampere.	A07	Electronic thermal overload protection for motor 2 (Overload detection level)	20 to 135% of the rated current (allowable continuous drive current) of the motor
A08	Electric thermal overload relay for motor 2 (Thermal time constant)	0.5 to 10 min	A08	Electronic thermal overload protection for motor 2 (Thermal time constant)	0.5 to 10.0 min
A09	Torque vector control 2	0: Inactive 1: Active	A14	Control mode selection 2	0: Disable (V/f operation with slip compensation inactive) 1: Enable (Dynamic torque vector operation)
A10	Motor 2 (Number of poles)	2 to 14	A15	Motor 2 (No. of poles)	2 to 22
A11	(Capacity)	0.01 to 5.50 kW (3.7 kW or less) 0.01 to 11.0 kW (5.5/7.5 kW)	A16	(Rated capacity)	0.01 to 11.0 kW
A12	(Rated current)	0.00 to 99.9 A	A17	(Rated current)	0.00 to 100.00 A
A13	(Tuning)	0,1,2	A18	(Auto-tuning)	0, 1, 2
A14	(On-line tuning)	0,1	A19	(Online tuning)	0,1
A15	(No-load current)	0.00 to 99.9 A	A20	(No-load current)	0.00 to 50.00 A
A16	(%R1 setting)	0.00 to 50.00%	A21	(%R1)	0.00 to 50.00%
A17	(%X setting)	0.00 to 50.00%	A22	(%X)	0.00 to 50.00%
A18	(Slip compensation control 2)	0.00 to 15.00 Hz	A26	(Rated slip frequency)	0.00 to 15.00 Hz (Set A23 and A25 to 100%)
A19	(Slip compensation response time)	0.01 to 10.00 s	A24	(Slip compensation response time)	0.01 to 10.00 s

App.

Torque Boost Conversion Table

E9S/E11S	FRENIC-Multi			E9S/E11S	FRENIC-Multi																										
	Data for F08/E09	Data for F09	Data for H50			Data for F05 × 0.100	Data for F05 × 0.108	Data for F05 × 0.116	Data for F05 × 0.125	Data for F05 × 0.133	Data for F05 × 0.141	Data for F05 × 0.149	Data for F05 × 0.157	Data for F05 × 0.166	Data for F05 × 0.174	Data for F05 × 0.182	Data for F05 × 0.190	Data for F05 × 0.198	Data for F05 × 0.207	Data for F05 × 0.215	Data for F05 × 0.223	Data for F05 × 0.231	Data for F05 × 0.239	Data for F05 × 0.248	Data for F05 × 0.256	Data for F05 × 0.264	Data for F05 × 0.272	Data for F05 × 0.280	Data for F05 × 0.289	Data for F05 × 0.297	Data for F05 × 0.305
3	0.0%			3	0.0%																										
4	0.6%			4	0.6 to 0.9%																										
5	1.3%			5	1.3 to 1.8%																										
6	1.9%			6	1.9 to 2.8%																										
7	2.6%			7	2.6 to 3.7%																										
8	3.2%			8	3.2 to 4.6%																										
9	3.8%			9	3.8 to 5.4%																										
10	4.5%			10	4.5 to 6.3%																										
11	5.1%			11	5.1 to 7.3%																										
12	5.7%			12	5.7 to 8.2%																										
13	6.4%			13	6.4 to 9.1%																										
14	7.0%			14	7.0 to 10.0%																										
15	7.7%			15	7.7 to 10.9%																										
16	8.3%			16	8.3 to 11.9%																										
17	8.9%	1/10 of data for F04		17	8.9 to 12.8%																										
18	9.6%			18	9.6 to 13.7%																										
19	10.2%			19	10.2 to 14.6%																										
20	10.8%			20	10.8 to 15.4%																										
21	11.5%			21	11.5 to 16.4%																										
22	12.1%			22	12.1 to 17.3%																										
23	12.8%			23	12.8 to 18.2%																										
24	13.4%			24	13.4 to 19.1%																										
25	14.0%			25	14.0 to 20.0%																										
26	14.7%			26	14.7 to 21.0%																										
27	15.3%			27	15.3 to 21.9%																										
28	15.9%			28	15.9 to 22.8%																										
29	16.6%			29	16.6 to 23.7%																										
30	17.2%			30	17.2 to 24.6%																										
31	17.9%			31	17.9 to 25.4%																										

Torque boost pattern of FVR-E9S/E11S

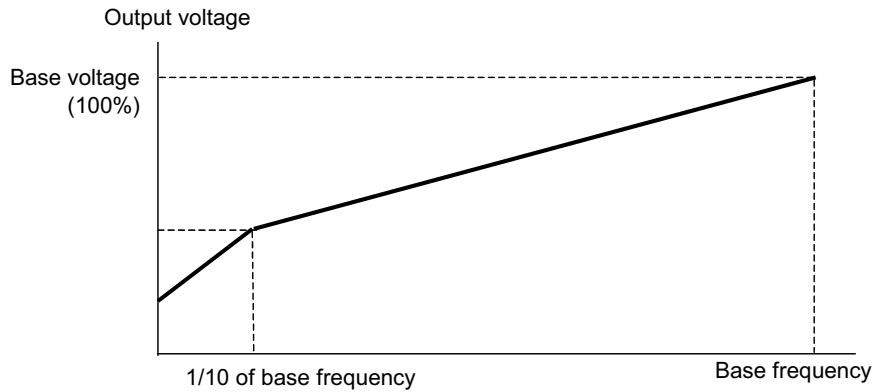

Torque boost pattern of FRENIC-Multi

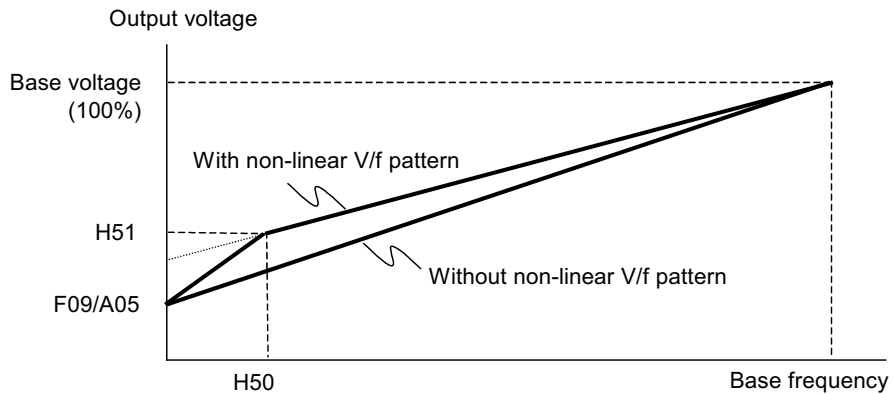

Glossary

This glossary explains the technical terms that are frequently used in this manual.

Acceleration time

Period required when an inverter accelerates its output from 0 Hz to the maximum output frequency.
Related function codes: F03, F07, E10, and H54

Alarm mode

One of the three operation modes supported by the inverter. If the inverter detects any malfunction, error, or fault in its operation, it immediately shuts down or trips the output to the motor and enters this mode in which corresponding alarm codes are displayed on the LED monitor.

Alarm output (for any faults)

A mechanical contact output signal that is generated when the inverter is halted by an alarm, by short-circuiting between terminals [30A] and [30C].
Related function code: E27
See Alarm mode.

Analog input

An external voltage or current input signal to give the inverter the frequency command. The analog voltage is applied on the terminal [12], the current on the [C1]. These terminals are also used to input the signal from the external potentiometer, PTC thermistor and PID feedback signals depending on the function code definition.
Related function codes: F01, C30, E59, E61 to E63 and J02

Analog output

An analog DC output signal of the monitored data such as the output frequency, the current and voltage inside an inverter. The signal drives an analog meter installed outside the inverter for indicating the current inverter running status.
Refer to Chapter 8, Section 8.3.1 "Terminal functions."

Automatic deceleration

A control mode in which deceleration time is automatically extended up to 3 times of the commanded time to prevent the inverter from tripping due to an overvoltage caused by regenerative power even if a braking resistor is not used.
Related function code: H69

Auto energy saving operation

Energy saving operation that automatically drives the motor with lower output voltage when the motor load has been light, for minimizing the product of voltage and current (electric power).
Related function codes: F37 and A13

AVR (Automatic Voltage Regulator) control

A control that keeps an output voltage constant regardless of variations of the input source voltage or load.

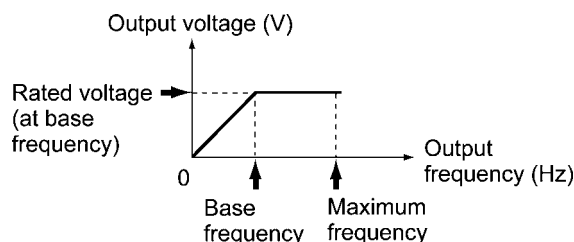
Base frequency

The minimum frequency at which an inverter delivers a constant voltage in the output V/f pattern.
Related function codes: F04 and A02

Bias

A value to be added to an analog input frequency to modify and produce the output frequency.
Related function codes: F18, C50 to C52

Braking torque

Torque that acts in a direction that will stop a rotating motor (or the force required to stop a running motor).

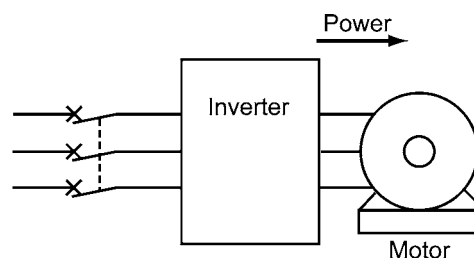

During accelerating or running at constant speed

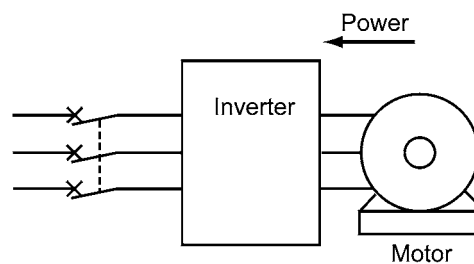

During decelerating

If a deceleration time is shorter than the natural stopping time (coast-to-stop) determined by a moment of inertia for a load machine, then the motor works as a generator when it decelerates, causing the kinetic energy of the load to be converted to electrical energy that is returned to the inverter from the motor. If this power (regenerative power) is consumed or accumulated by the inverter, the motor generates a braking force called "braking torque."

Carrier frequency

Frequency used to establish the modulation period of a pulse width under the PWM control system. The higher the carrier frequency, the closer the inverter output current approaches a sinusoidal waveform and the quieter the motor becomes.

Related function code: F26

Coast-to-stop

If the inverter stops its output when the motor is running, the motor will coast to a stop due to inertial force.

Communications link function

A feature to control an inverter from external equipment serially linked to the inverter such as a PC or PLC.

Related function code: H30

Constant feeding rate time

Time required for an object to move in a constant distance previously defined. The faster speed, the shorter time and vice versa. This facility may be applied to a chemical process that determines a processing time of materials as the speed such as heating, cooling, drying, or infiltration in some constant-speed machinery.

Related function codes: E39 and E50.

Constant output load

A constant output load is characterized by:

- 1) The required torque is in inverse proportion to the load shaft speed
- 2) An essentially constant power requirement

Related function code: F37 and A13

Applications: Machine tool spindles

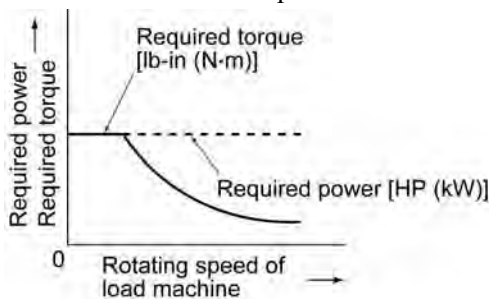

Constant torque load

A constant torque load is characterized by:

- 1) A requirement for an essentially constant torque, regardless of the load shaft speed
- 2) A power requirement that decreases in proportion to the load shaft speed

Related function code: F37 and A13

Applications: Conveyors, elevators, and carrier machines

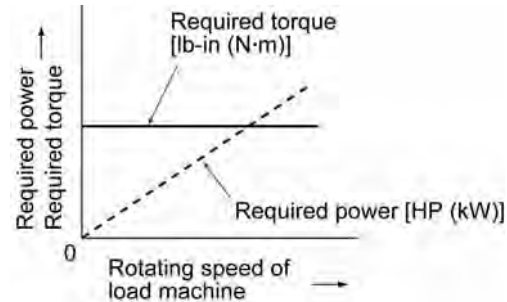

Control circuit terminals

Terminals on the inverter, which are used for input/output of signals to control or manage the inverter/external equipment directly or indirectly

Current limiter

A control that keeps an inverter output frequency within the specified current limit.

Cursor

Marker blinking on the four-digit, 7-segment LED monitor which shows that data in the blinking digit can be changed/modified by keying operation.

Curvilinear V/f pattern

A generic name for the inverter output patterns with curvilinear relation between the frequency and voltage.

Refer to function code H07 in Chapter 9, Section 9.2.5 "H codes."

DC braking (DC braking)

DC current braking that an inverter injects into the motor to brake and stop it against the moment of inertia of the motor or its load. The inertial energy generated is consumed as heat in the motor.

If a motor having the load with large moment of inertia is going to stop abruptly, the moment of inertia may force to rotate the motor after the inverter output frequency has been reduced to 0 Hz. Use DC braking to stop the motor completely.

Related function codes: F20 to F22 and A09 to A11

DC link bus voltage

Voltage at the DC link bus that is the end stage of the converter part of inverters. The part rectifies the input AC power to charge the DC link bus capacitor as the DC power to be inverted to AC power.

Deceleration time

Period during which an inverter slows its output frequency down from the maximum to 0 Hz.

Related function codes: F03, F08, E11, and H54

Digital input

Input signals given to the programmable input terminals or the programmable input terminals themselves. A command assigned to the digital input is called the terminal command to control the inverter externally.

Refer to Chapter 8, Section 8.3.1 "Terminal functions."

Electronic thermal overload protection

Electronic thermal overload protection to issue an early warning of the motor overheating to safeguard a motor.

An inverter calculates the motor overheat condition based on the internal data (given by function code P99/A39 about the properties of the motor) and the driving conditions such as the drive current, voltage and frequency.

External potentiometer

A potentiometer (optional) that is used to set frequencies as well as built-in one.

Fan stop operation

A mode of control in which the cooling fan is shut down if the internal temperature in the inverter is low and when no operation command is issued.

Related function code: H06

Frequency accuracy (stability)

The percentage of variations in output frequency to a predefined maximum frequency.

Frequency limiter

Frequency limiter used inside the inverter to control the internal drive frequency in order to keep the motor speed within the specified level between the peak and bottom frequencies.

Related function codes: F15, F16, and H64

Frequency resolution

The minimum step, or increment, in which output frequency is varied, rather than continuously.

Function code

Code to customize the inverter. Setting function codes realizes the potential capability of the inverter to meet it for the individual power system applications.

Gain (for frequency setting)

A frequency setting gain enables varying the slope of the output of the frequency set with an analog input signal.

Related function codes: C32, C34, C37, C39, C42, and C44

IGBT (Insulated Gate Bipolar Transistor)

Stands for Insulated Gate Bipolar Transistor that enables the inverter section to switch high voltage/current DC power in very high speed and to output pulse train.

Interphase unbalance

A condition of an AC input voltage (supply voltage) that states the voltage balance of each phase in an expression as:

$$\text{Interphase voltage unbalance (\%)} = \frac{\text{Max.voltage (V)} - \text{Min.voltage (V)}}{\text{Three-phase average voltage (V)}} \times 67$$

Inverse mode operation

A mode of operation in which the output frequency lowers as the analog input signal level rises.

Jogging operation

A special operation mode of inverters, in which a motor jogs forward or reverse for a short time at a slower speed than usual operating modes.

Related function codes: C20 and H54

Jump frequencies

Frequencies that have a certain output with no change in the output frequency within the specified frequency band in order to skip the resonance point of a machine (resonance frequency).

Related function codes: C01 to C04

Keypad operation

To use a keypad to run an inverter.

Line speed

Running speed of an object (e.g., conveyor) driven by the motor. The unit is meter per minute, m/min.

Load shaft speed

Number of revolutions per minute (r/min) of a rotating load driven by the motor, such as a fan.

Main circuit terminals

Power input/output terminals of an inverter, which includes terminals to connect the power supply, motor, DC reactor, braking resistor, and other power components.

Maximum frequency

The output frequency commanded by the input of the maximum value of a frequency setup signal (for example, 10 V for a voltage input range of 0 to 10 V or 20 mA for a current input range of 4 to 20 mA).

Related function codes: F03 and A01

Modbus RTU

Communication protocol used in global FA network market, which is developed by Modicon, Inc. USA.

Momentary voltage drop immunity

The minimum voltage (V) and time (ms) that permit continued rotation of the motor after a momentary voltage drop (momentary power failure).

Multi-frequency selection

To preset frequencies (up to 15 stages), then select them at some later time using external signals.

Related function codes: E01 to E05, C05 to C19

Nominal applied motor

Rated output (in kW) of a general-purpose motor that is used as a standard motor listed in tables in Chapter 6, "SELECTING PERIPHERAL EQUIPMENT" and Chapter 8, "SPECIFICATIONS."

Overload capability

The overload current that an inverter can tolerate, expressed as a percentage of the rated output current and also as a permissible energization time.

PID control

The scheme of control that brings controlled objects to a desired value quickly and accurately, and which consists of three categories of action: proportional, integral and differential.

Proportional action minimizes errors from a set point. Integral action resets errors from a desired value to 0. Differential action applies a control value in proportion to a differential component of the difference between the PID reference and feedback values.

Related function codes: E01 to E05, E40, E41, E43, E61 to E63, C51, C52, J01 to J62

Programming mode

One of the three operation modes supported by the inverter. This mode uses the menu-driven system and allows the user to set function codes or check the inverter status/maintenance information.

PTC (Positive Temperature Coefficient)

thermistor

Type of thermistor with a positive temperature coefficient. Used to safeguard a motor.

Related function codes: H26 and H27

Rated capacity

The rating of an inverter output capacity (at the secondary side), or the apparent power that is represented by the rated output voltage times the rated output current, which is calculated by solving the following equation and is stated in kVA:

$$\begin{aligned} \text{Rated capacity (kVA)} \\ &= \sqrt{3} \times \text{Rated output voltage (V)} \\ &\quad \times \text{Rated output current (A)} \times 10^{-3} \end{aligned}$$

The rated output voltage is assumed to be 220 V for 230 V equipment and 440 V for 460 V equipment.

Rated output current

A total RMS equivalent to the current that flows through the output terminal under the rated input and output conditions (the output voltage, current, frequency, and load factor meet their rated conditions). Essentially, inverter rated at 200 V covers the current of a 200 V, 50 Hz 6-pole motor and inverter rated at 400 V covers the current of a 380 V, 50 Hz 4-pole motor.

Rated output voltage

A fundamental wave RMS equivalent to the voltage that is generated across the output terminal when the AC input voltage (supply voltage) and frequency meet their rated conditions and the output frequency of the inverter equals the base frequency.

Required power supply capacity

The capacity required of a power supply for an inverter. This is calculated by solving either of the following equations and is stated in kVA:

$$\begin{aligned} \text{Required power supply capacity (kVA)} \\ &= \sqrt{3} \times 200 \times \text{Input RMS current (200 V, 50 Hz)} \\ &\text{or} \\ &= \sqrt{3} \times 220 \times \text{Input RMS current (220 V, 60 Hz)} \\ \text{Required power supply capacity (kVA)} \\ &= \sqrt{3} \times 400 \times \text{Input RMS current (400 V, 50 Hz)} \\ &\text{or} \\ &= \sqrt{3} \times 440 \times \text{Input RMS current (40 V, 60 Hz)} \end{aligned}$$

Running mode

One of the three operation modes supported by the inverter. If the inverter is turned ON, it automatically enters this mode which you may: run/stop the motor, set up the set frequency, monitor the running status, and jog the motor.

S-curve acceleration/deceleration

(weak/strong)

To reduce the shock to the machine during acceleration/deceleration, the inverter gradually accelerates/decelerates the motor at the both ends of the acceleration/deceleration zones like a figure of S letter.

Related function code: H07

Slip compensation control

A mode of control in which the output frequency of an inverter plus an amount of slip compensation is used as an actual output frequency to compensate for motor slippage.

Related function codes: P09 to P12 and A23 to A26

Stall

A behavior of a motor when it loses speed by tripping of the inverter due to overcurrent detection or other malfunctions of the inverter.

Starting frequency

The minimum frequency at which an inverter starts its output (not the frequency at which a motor starts rotating).

Related function codes: F23 and A12

Starting torque

Torque that a motor produces when it starts rotating (or the drive torque with which the motor can run a load).

Simultaneous keying

To simultaneously press the 2 keys on the keypad. This presents the special function of inverters.

Stop frequency

The output frequency at which an inverter stops its output.

Related function code: F25

Thermal time constant

The time needed to activate the electronic thermal overload protection after the preset operation level (current) continuously flows. This is an adjustable function code data to meet the property of a motor that is not manufactured by Fuji Electric.

Related function codes: F12 and A08

Torque boost

If a general-purpose motor is run with an inverter, voltage drops will have a pronounced effect in a low-frequency region, reducing the motor output torque. In a low-frequency range, therefore, to increase the motor output torque, it is necessary to increase the output voltage. This process of voltage compensation is called torque boost.

Related function codes: F09 and A05

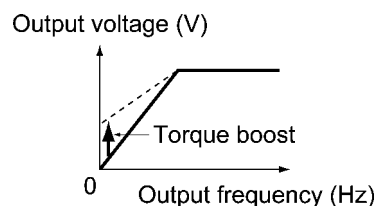

Transistor output

A control signal that generates predefined data from within an inverter via a transistor (open collector).

Trip

In response to an overvoltage, overcurrent, or any other unusual condition, actuation of an inverter's protective circuit to stop the inverter output.

V/f characteristic

A characteristic expression of the variations in output voltage V (V), and relative to variations in output frequency f (Hz). To achieve efficient motor operation, an appropriate V/f (voltage/frequency) characteristic helps a motor produce its output torque matching the torque characteristics of a load.

V/f control

The rotating speed N (r/min) of a motor can be stated in an expression as

$$N = \frac{120 \times f}{p} \times (1-s)$$

where,

f : Output frequency

p : Number of poles

s : Slippage

On the basis of this expression, varying the output frequency varies the speed of the motor. However, simply varying the output frequency f (Hz) would result in an overheated motor or would not allow the motor to demonstrate its optimum utility if the output voltage V (V) remains constant. For this reason, the output voltage V must be varied with the output frequency f by using an inverter. This scheme of control is called V/f control.

Variable torque load

A squared torque load is characterized by:

- 1) A change in the required torque in proportion to the square of the number of revolutions per minute.
- 2) A power requirement that decreases in proportion to the cube of the decrease in the number of revolutions per minute.

$$\begin{aligned} &\text{Required power (kW)} \\ &= \frac{\text{Rotating speed (r/min)} \times \text{Torque (N} \cdot \text{m)}}{9.55} \end{aligned}$$

Related function code: F37 and A13

Applications: Fans and pumps

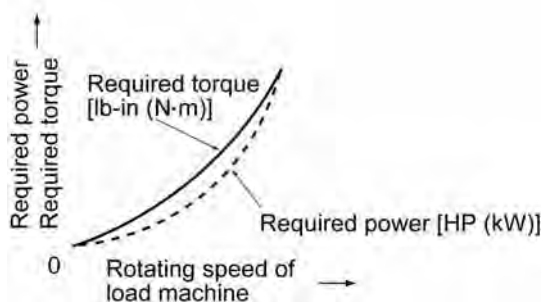

Voltage and frequency variations

Variations in the input voltage or frequency within permissible limits. Variations outside these limits might cause an inverter or motor to fail.

High Performance Compact Inverter

FRENIC-Multi

User's Manual

First Edition, June 2007

Fuji Electric FA Components & Systems Co., Ltd.

Fuji Electric Corp. of America

The purpose of this manual is to provide accurate information in the handling, setting up and operating of the FRENIC-Multi series of inverters. Please feel free to send your comments regarding any errors or omissions you may have found, or any suggestions you may have for generally improving the manual.

In no event will Fuji Electric FA Components & Systems Co., Ltd. be liable for any direct or indirect damages resulting from the application of the information in this manual.

